THESES SIS/LIBRARY
R.G. MENZIES LIBRARY BUILDING NO:2
THE AUSTRALIAN NATIONAL UNIVERSITY
CANBERRA ACT 0200 AUSTRALIA

TELEPHONE: +61 2 6125 4631
FACSIMILE: +61 2 6125 4063
EMAIL: library.theses@anu.edu.au

USE OF THESES

This copy is supplied for purposes
of private study and research only.
Passages from the thesis may not be
copied or closely paraphrased without the
written consent of the author.

YOLŃU COSMOLOGY:

**An unchanging cosmos incorporating a rapidly changing
world?**

John Rudder

**A thesis submitted for the degree of Doctor of
Philosophy of the Australian National University in
May 1993.**

**I certify that all parts of this thesis are my own
work except where otherwise acknowledged.**

John Rudder.

John Rudder

PREFACE.

The data on which this thesis is based were obtained largely during the course of 12 months of fieldwork in North East Arnhem Land between November 1988 and July 1989, then from May to August in 1990. Apart from brief periods, totalling about six weeks at Yirrkala the rest of the research was carried out at Galiwin'ku. However it is also the culmination of a much longer period of learning from the Yolŋu, a process which began in 1964 with residence at Yirrkala for three years, and following that at Galiwin'ku for ten years from 1967 to 1977. During that time I was interested in and learning about the Yolŋu world, but it was only during the twelve months of field work that I was able to give my whole attention to the task.

My original intention for the fieldwork was to simply sit down with the old men, record from them data on ideas of time, space and the physical and spiritual worlds and then to produce a descriptive analysis of the Yolŋu Cosmos from that. While I knew that some of the old men had died during my ten years' absence, I had not realised how few were left, nor how fragile their health had become. Any time that they were able to give me was very precious. In practice a new generation was replacing them and most of these men and women also had very full lives. Those who made time to share with me their knowledge and their thoughts did so out of schedules that were extremely full, and they did this on the basis of friendship rather than as paid informants. They taught me the absolute centrality to Yolŋu cosmology of the notions of relationships, and they instructed me on the contrasts between "your" ideas of change and "our" ideas of changelessness and transformation. In addition to this a number of men shared with me ideas associated with the Morning Star, a myth/ritual complex that is shared by most of the Dhuwa clans of Arnhem Land. In particular these included Wadaymu from the Njaimil, Djiniyini and Danatara from the Golumala and the

two old Djambarrpuyŋu men who have since died. When I visited Yirrkala, Daymbalipu from the Djapu and Witiyana's father from the Rirratjŋu added to this.

I am in debt to a whole generation of older leaders from both Yirrkala and Galiwin'ku, for their continuous patient instruction. In particular the ritual leaders of the Rirratjŋu and Dhalwaŋu people from Yirrkala and of the Gälpu, Djambarrpuyŋu and Wangurri at Galiwin'ku. In particular Djorripum, Galpagalpa and Badaltja. The majority of them are no longer with us. The new generation of leaders, living in an almost totally different world from their parents, have been able to show me that they see it as still the same world. Not only those people I have mentioned above, but also Djalangi and his mother, father and brothers, Mawunydjil, Maratja and Guruwanawuy, Neparrŋa and Djangirrawuy, Dayŋumbu and Rrurrambu; have all made valuable contributions, as have Daypurryun 2, Bunbatjun, Rronaŋ and Ganhdhuwuy . In addition to these I have been much helped by Rarrkminy and Yurranydjil, Bänydji and Daŋanbarr, Guthadjaka, Nändama and Gapany, Guywaŋa, Marrŋanyin and Ganyinurru. People with great insight, understanding and knowledge. These lists cannot include all the names, nor can they express the depth of relationships and feelings involved. They can only give an indication of of the breadth of the North East Arnhem Land community who have had input into the finished product.

One of the new generation of leaders said to me in a public meeting, "We have taught you, we would like you to teach your people the true story about us". If this thesis can make a step towards fulfilling that expectation I am thankful.

As far as discussion of anything secret within this thesis, I have not knowingly disclosed anything that should not be told, and I have not included photos of anything that cannot be seen by women and children. However, by the time this is written it is possible for information declared as open to me to have become restricted since then, and there is no way of knowing this. In any case, all references to religious content and thought need to be handled with respect. Without

including what I have, there would only be a shadow of the richness of Yolŋu thought. As it is, what I have written is more an indication, and a skimming of the surface than a full expression.

My fieldwork and some of the time for the development of this thesis have been supported by the Australian Institute of Aboriginal and Torres Strait Islander Studies, and the rest has been supported by my wife Trixie. Without this support it would not have been possible.

Many non-Aboriginal people have encouraged, supported and prodded me during the course of fieldwork. To all of them I express my thanks. Specific mention must be made of the late Dianne Buchanan, linguist and long time supporter who, with her co-worker Margaret, helped to keep me in a reasonable state of sanity while I was away from home and family. At both Yirrkala and Galiwin'ku the members of M.A.F. were a great help as were the teachers at both schools, especially Michael Christie at Yirrkala.

Last, but not least, I need to thank Ian Keen, whose reading and re-reading of successive drafts provoked me to think through issues and present them clearly, without imposing another mould on me than my own. As for the diagrams, illustrations, photos and typing, I am responsible except where acknowledged.

ABSTRACT.

This thesis is first and foremost a descriptive ethnography of the cosmology of the Yolŋu people who live in the North East Arnhem Land region of the Northern Territory of Australia. Supplementary to that description it explores the relationship between the Yolŋu presupposition of changelessness, the rapidly changing world in which they live and their cosmology.

The thesis is divided into four sections. The first briefly explores the theoretical frameworks to which it relates in terms of the literature on cosmology and world view, presupposition and the taken-for-granted, and extends into an introductory discussion of the Yolŋu understandings of the area of thought frequently referred to in English as the spiritual, the metaphysical, or the supernatural. The second section examines human relationships, first from a diachronic perspective and secondly from a synchronic one. The third examines two conceptual areas which relate most closely to Western notions of cosmology in an examination of the Yolŋu notions of space and time. Finally the various themes of the thesis are drawn together in two ways. First in an examination of their application in a myth-ritual complex called Banumbirr (the Morning Star) and last of all in an analysis of the ways in which the Morning Star complex, together with the perceptions of relationships, of space, of time and of the supernatural combine to present a corporate model of a cosmos which, while seen to be not changing is structured in such a way as to be able to incorporate change within changelessness.

This is an examination of cosmology in a changing world, presuppositions of changelessness, and the present Yolŋu responses to change. In examining these, it provides as a by-product, a foundation for the study of the effects of future change on cosmology and presuppositions, and a means by which these may be assessed.

TABLE OF CONTENTS.

PREFACE.....	iii
ABSTRACT.	vi
TABLE OF CONTENTS.	vii
LIST OF ILLUSTRATIONS.	xii
CHAPTER 1. INTRODUCTION.	1
THE YOLŊU OF NORTH EAST ARNHEM LAND.	1
APPROACH TO ANALYSIS.....	7
COSMOLOGY, WORLD VIEW AND CHANGE.	14
SOME YOLŊU CONCEPTS.....	19
Networks of Relationships.....	20
Identity.....	21
Focus.....	23
Change and Transformation	26
Inside and Outside.....	28
THE SIGNIFICANCE OF LAND AND SACREDNESS IN IDENTITY.	30
APPROACH TO DESCRIPTION.....	31
CHAPTER 2. THE ETERNAL COSMOS.	34
INTRODUCTION.....	34
MANIFESTATIONS OF THE INSIDE OF REALITY.	35
"Children".....	36
Mokuy.....	37
Birrimbirr.....	40
Totems.....	41
Wajarr, The Ancestral Beings.....	43
The Djaŋ'kawu myth.	45
The Wäwilak Myth.....	46
Barama, Lany'tjun, Galparrimun.....	47
Traces.....	48
The Holy Spirit.....	53
TAPPING POWER.....	54
Marrŋgitj.	54
Galka.....	56
Nyera	56
Substances Used in Tapping Power.....	57

Ancestral Power.....	59
RELATIONS WITH THE INSIDE OF REALITY	
THROUGH THE RELIGIOUS SYSTEM.....	61
Vehicles of Religious Knowledge.....	61
Myth as a vehicle for recording the establishment and	
maintenance of relations between groups.....	63
Analogue as a vehicle for the control of Religious	
Knowledge.....	66
Control of Religious Knowledge.....	69
THE TWO REVIVALS.....	72
CONCLUSION.	77
CHAPTER 3. THE PASSAGE THROUGH LIFE.....	79
INTRODUCTION.....	79
Whole and Part.....	79
Notions of Life and Living.....	81
The Transformation of Living Things.....	82
HUMAN LIFE CYCLE.....	86
THE "RELIGIOUS" LIFE CYCLE.....	88
EXISTENCE BEFORE HUMAN LIFE.....	90
THE HUMAN LIFE CYCLE.....	94
LIFE AFTER DEATH.....	105
Where do the dead go?.....	106
The Journey to the place of the Life after Death.....	113
The Nature of the Afterlife.....	114
Processing the Dead.....	116
CONCLUSION.....	125
CHAPTER 4. THE PERSONAL COSMOS.....	127
INTRODUCTION : A HUMAN WORLD.....	127
THE CLOSE WORLD : RELATIONSHIPS WITHIN THE	
FAMILY.....	132
THE NEAR WORLD : RELATIONS BEYOND THE	
CLOSE FAMILY.....	141
The Ideal Marriage Pattern.....	146
THE MORE DISTANT WORLD: RELATIONS BETWEEN	
CLANS.....	164
CONCLUSION.....	176
CHAPTER 5. RELATIONSHIPS WITH SPACE.....	177
INTRODUCTION.....	177
CONCEPTUALISATION OF SPACE.....	178

The Relationship between Focus and Boundary.....	178
Classifications of Space and the Naming of Sites.....	185
Distance, Location and Direction in Space.	189
RELATIONSHIPS WITH SPACE.....	193
Land and Identity.....	193
Elcho Island.....	202
Dhambalarjur.....	210
Galiwin'ku Township.....	225
Space Beyond Arnhem Land.....	237
CONCLUSION.	240
CHAPTER 6. YOLŊU TIME.....	240
INTRODUCTION.....	240
The Western Notions of Time.	240
Yolŋu notions of Time.	243
TEMPORAL LOCATIONS.....	245
Features of the repeated patterns of Day and Night.....	246
The Repeating Pattern of Seasons.	250
Other Repeating Patterns of Temporal Locations	254
Associated with the Moon.....	254
The Tides and Tidal Currents.	256
The Stars.	257
Repeating events relating to plants.....	260
Incorporations and Changes since Western Contact.....	260
CONCEPTUALISATION OF TEMPORAL SPACE AS	
REFLECTED IN THE LANGUAGE.....	264
Verbs.....	264
The Demonstratives.....	267
The Construction of the Terminology of Temporal	
Location.....	267
Temporal Words and the Structure of Descriptive	
Terms.....	268
DISTANCE IN TEMPORAL SPACE.....	270
CONCLUSION.	277
CHAPTER 7. BANUMBIRR : THE COSMOS PORTRAYED.....	279
INTRODUCTION.....	279
THE ŊAYMIL FOCUS.....	282
Story of Banumbirr as told by Wadaymu.....	283
A bark painting of Banumbirr, by Wadaymu.	287
The Story of the Fish, Warrukay. Multiple Meanings.....	293

THE GAPINY GROUP'S PERSPECTIVE.....	296
Banumbirr and Title Claims.....	300
Relations between clans.....	304
Concerning Birth and Death.....	305
OUTWARD CONNECTIONS THROUGH BANUMBIRR.....	307
Gälpu Perspectives.....	307
Djambarrpuyñu ideas of the various types of	
Banumbirr.....	316
Djapu Connections.....	319
Rirratjñu ideas about Banumbirr.....	320
Clans Linked by Banumbirr.....	322
NARRATIVE VERSIONS.....	326
CONCLUSION.....	332
CHAPTER 8. CONCLUSION.....	335
TIMELESSNESS AND CHANGELESSNESS.....	335
MODELS OF THE COSMOS.....	342
Banumbirr as cosmos model.....	342
Elements of the Complex.....	343
Clan Perspectives on Banumbirr.....	346
Banumbirr as a complex of Entities relating to	
the Inside of Reality.....	348
Messages of the Complex - Analogues of the	
Cosmos.....	355
Entry into the inside.....	356
The Afterlife.....	356
The Passage Through Life.....	357
The Place and Nature of Man.....	358
The Place and Nature of Woman.....	358
The Nature of Existence / Identity.....	359
The Banumbirr Complex as a Model of the	
Cosmos.....	359
Human Relations as Cosmos Model.....	363
Relations with Land as Cosmos Model.....	364
CONCLUSION. THE MODELLED COSMOS.....	368
BIBLIOGRAPHY.....	370

APPENDICES.

A. Orthography used for spelling of Yolŋu words.....	382
B. Myth of Yawulŋura's journey to Burralku.....	383
C. Song of the Turtle Harpoon Rope.....	386
D. Myth of the Turtle Harpoon Rope	388
E. Story of the journey taken by the deceased in order to reach Burralku	390
F. Story of Banumbirr, told by Wadaymu.....	392
G. Summary of Warner's version of the Banumbirr Myth.....	404
H. Story of Banumbirr, told by Galpagalpa.....	406
I. Wuluwuma and the origin of the Morning Star	420

LIST OF ILLUSTRATIONS.

Figures.

Figure 1.1. System of naming areas on basis of significant focal points.	25
Figure 1.2. The relationships between different levels of insideness or outsideness of ritual invocations.	29
Figure 2.1. Djorrrpum's drawing of Djaŋ'kawu	44
Figure 2.2. Shark Site on Martjanba Island.....	49
Figure 3.1. Life cycle of the cycad palm.....	83
Figure 3.2. Classifications of maturity stages of natural species.	84
Figure 3.3. Stages of child development..	87
Figure 3.4. Structural analysis of the turtle harpoon rope myth	95
Figure 3.5. The physical life cycle of a man.....	96
Figure 3.6. The life cycle of a woman.....	97
Figure 3.7. Stages of the creation and life of a ranga.....	98
Figure 3.8. Spiral diagram of analogical reference to ranga creation	99
Figure 3.9. The stages of a man's journey through life and then through death to Burralku, the home of the dead.....	101
Figure 4.1. Gapany's world.....	129
Figure 4.2. Me and My Family. (After Maratja).....	136
Figure 4.3. Members of Muŋunayŋu's and Lurrthaypuyŋu's households	136
Figure 4.4. Maratja and Gapany's Household. (July 1990).....	136
Figure 4.5. Bapawun' and Gundjirrirr's Family and Household (April 1991)	138
Figure 4.6. Rarrkminy's Household (July 1990).....	138
Figure 4.7. Hypothetical system for Yolŋu Kinship Terminology	144
Figure 4.8. First Choice set of Marriages relationships according to <i>mälk</i>	148
Figure 4.9. Second Choice set of Marriage relationships according to <i>mälk</i>	148
Figure 4.10. The Ideal marriage pattern for Gundapuy - Djambarrpuyŋu clan.....	152
Figure 4.11. The Ideal marriage pattern for Gumatj-Yunupiŋu clan.....	154
Figure 4.12. Daŋataŋa marries his mother's brother's daughter.....	157
Figure 4.13. Daŋataŋa marries his mother's mother's sister's son's daughter.....	157
Figure 4.14. Daŋataŋa marries his mother's mother's brother's daughter's daughter.....	157
Figure 4.15. Daŋataŋa's illustration of Baŋumbirr as yam as lineage	159
Figure 4.16. Daŋataŋa's lineage illustrated as yam plants	159
Figure 4.17. Relations between clans in terms of yams.....	160

Figure 4.18. Clans and places linked by the travels of Banumbirr.....	161
Figure 4.19. Some of the Yolŋu Language groupings (not exhaustive).....	166
Figure 4. 20. Djambarrpuyŋu classifications (after Wanymuli).....	173
Figure 5.1. Relationships between focal points and adjacent land.....	183
Figure 5.2. Anthropomorphic features of the landscape.....	186
Figure 5.3. Compass and wind directions.....	192
Figure 5.4. Features of bark painting by Daypurryun. (A.N.G. No 83.3198).	221
Figure 6.1. Pattern of sequential temporal locations relating to day and night.....	248
Figure 6.2. Relation between Yolŋu and Western calender terms.....	253
Figure 6.3. Succession of temporal locations based on Family Events.....	272
Figure 6.4. Precision of temporal location based on terms for seasons.....	273
Figure 6.5. Precision of temporal location based on Daily Events.....	273
Figure 7.1. Details in Wadaymu's Painting of Banumbirr.....	291
Figure 7.2. Sketch of Djambarrpuyŋu Banumbirr.....	315
Figure 7.3. Sketch of Rirratjŋu Banumbirr.....	315
Figure 7.4. Sketch of Mawuka painting by Banygul.....	321

Maps.

Map 1.1. Main territorial divisions of North East Arnhem Land.....	3
Map 1.2. Northern half of Northern Territory showing centres with which the Yolŋu have contact.....	6
Map 2.1. Shark Site on Martjanba Island.....	50
Map 3.1. Wangurri funeral site at Mayawurrthal'wuy's house.....	122
Map 3.2. Journey taken with coffin to enable the deceased to have a final look at and say goodbye to the town.....	123
Map 5.1. Pattern of bestowal of women from one site to another , based on ideal marriage patterns.....	195
Map 5.2. Some Outstation/Homeland Centres in North East Arnhem Land.....	198
Map 5.3. Some connections between sites made by the journeys of ancestral beings.....	203
Map 5.4. Elcho Island. Major moiety divisions.....	205
Map 5.5. Djar'kawu sites at Dhambalanur.....	212
Map 5.6. Galiwin'ku township showing approximate development stages.....	225
Map 5.7. Galiwin'ku township showing areas of clan settlement and Cemeteries.....	227
Map 6.1. Some major Arnhem Land marine currents.....	258
Map 7.1. Naymil Version of Journey of Banumbirr.....	288

Map 7.2. Gälpu Version of Journeys of Banumbirr.....	309
Map 7.3. Djambarrpuyñu Version of Journey of Banumbirr.....	313

Plates.

Plate 2.1. Shark's liver Site on Martjanba Island.....	51
Plate 2.2. Shark's brain Site on Martjanba Island.....	51
Plate 3.1. Wangurri funeral site.....	124
Plate 5.1. Djañ'kawu site, Dhulmu Njërra, at Minbirrkmirriñur.....	214
Plate 5.2. Djañ'kawu clapsticks at Dhambalañur.....	215
Plate 5.3. Bark Painting of Djañ'kawu site at Minbirrkmirriñur.....	219
Plate 5.4. Graves in the Gälpu Cemetery.....	231
Plate 5.5. Graves in the Golumala Cemetery at Njalkanñur.....	232
Plate 5.6. Djambarrpuyñu -Guyula Grave beside the "Elcho Island Memorial".....	233
Plate 7.1. Wañaymu's Painting of Banumbirr.....	289
Plate 7.2. Wañaymu's Painting of Warrukay.....	294
Plate 7.3. Cross of Christ with thieves represented by Warrukay.....	298
Plate 7.4. Painting of Warrukay nailed over the hospital entrance.....	301
Plate 7.5. Warrukay painting showing Banumbirr poles along the sides.....	301
Plate 7.6. Mandjuwi's painting of Banumbirr as yam.....	310
Plate 7.7. Gälpu spirit beings who made Banumbirr.....	311
Plate 7.8. Gälpu spirit beings gathering the yam <i>gulaka/ganguri</i>	312
Plate 7.9. Djapu Clan Painting of Banumbirr by Mäw'.....	317
Plate 7.10. More abstract Djapu Clan Painting of Banumbirr by Mäw'.....	318

Tables.

Table 2.1. Mokuys.....	39
Table 4.1. Djambarrpuyñu groups according to site affiliation.....	168
Table 4.2. Distinctions made between Djambarrpuyñu groups.....	170-171
Table 5.1. Definitions of Deictic pronouns as given by four people.....	191
Table 5.2. Outstations/Homeland Centres in North East Arnhem Land.....	200
Table 6.1. Terms used to identify sections of the day.....	247
Table 6.2. Terms used to identify temporal spaces of the night.....	249
Table 6.3. One version of the sequence of season terms in Arnhem Land.....	252
Table 6.4. Relationships between seasons and cycles of nature.....	255
Table 6.5. Seasonal availability of <i>Natha</i> (carbohydrate vegetable foods).....	260
Table 6.6. Verb tenses in Gupapuyñu.....	263
Table 6.7. Relationships between Verb Forms and Temporal Locations.....	265
Table 6.8. Relationships between Demonstratives and Time Locations.....	266
Table 8.1. Interpretations of the elements of the Banumbirr complex.....	345

Table 8.2. Interpretations of the elements of the yam transformation of the Banumbirr complex.	346
Table 8.3. Interpretations of the elements of the barracouta transformation of the Banumbirrcomplex.....	346
Table 8.4. Table of clan and site location of mokuys said to construct Banumbirr	351

CHAPTER 1. INTRODUCTION.

THE YOLŊU OF NORTH EAST ARNHAM LAND

APPROACH TO ANALYSIS.

COSMOLOGY, WORLD VIEW AND CHANGE.

SOME YOLŊU CONCEPTS

Networks of Relationships

Identity

Focus.

Change and Transformation

Inside and Outside

**THE SIGNIFICANCE OF LAND AND SACREDNESS IN
IDENTITY**

APPROACH TO DESCRIPTION

INTRODUCTION.

THE YOLŪU OF NORTH EAST ARNHEM LAND.

This thesis is focussed on the cosmological understandings of the people of North East Arnhem Land, a people who have been given a variety of names in the earlier Anthropological literature, but who are currently called the Yolŷu (lit. person). The central problem considered is how they as a people are able to live in a world that is constantly changing around them and assert categorically that the world does not change. This fundamental problem raises other separate issues such as,

1. How is change understood?
2. What kind of world or cosmos is perceived to exist? How is it structured and how do humans relate to it?
3. How is identity structured and how are diachronic relations understood and managed?
4. In what ways are the everchanging patterns of human distribution over the land interpreted and controlled?
5. How is time understood?

Each of these supplementary problems forms the basis for the discussion in separate chapters; however before considering them further, I need to provide a brief introduction to the people themselves and to their world, and give an overview of the theoretical framework in which this thesis is set.

The Yolŷu speak a number of distinct languages most of which are represented by several dialects. While I counted twenty-one separately named dialects that were claimed to be spoken on Elcho Island, it is possible that there may have been as many as forty or even more spread across North East Arnhem

Land. The Yolŋu group these dialects according to the word used for "this", and name the groups by that word with the addition of a genitive suffix. Thus there are the *dhuwalamirri*, *dhuwalmirr*, *dhaŋumi*, *djaŋumi*, and several others (see Figure 4.19) forming an enclave of pama-nyungan speakers whose neighbours are all non-pama-nyungan. While each of the dialect groups is affiliated with one or more territorial location, there is a generally recognised grouping of the people into five major and usually overlapping groups according to the location of their homelands. These, shown in Map 1.1, also overlap most linguistic groupings. Map 1.2, gives some idea of the major Yolŋu centres and the outside centres with which they have regular contact.

The local history and prehistory involves a continuous record of change and of contact with outsiders. The mythology records some who were Yolŋu innovators, but also refers to contact over a long period with Indonesian *trepang* fishermen who came in quite large numbers from Makassar in the Celebes. Since their visits were officially terminated by the Australian Government in 1906 there have been contacts with Japanese pearl divers and more recently, white Australians in continuously greater numbers. Prior to World War II these white Australians were mainly missionaries and the occasional administrator. During the war there were many new experiences, including allied air force bases along the coast, and Japanese bombing raids. In addition a small number of men from a wide group of clans were formed into a Special Reconnaissance Unit of the Australian Army by the anthropologist Donald Thomson.¹

Starting in the 1930s but particularly after the war, there was a spontaneous movement of people towards centres along the coast that were established mostly by missionaries from the Methodist Overseas Missions. These became centres for obtaining goods, and centres of refuge from

¹ See Thomson 1983.

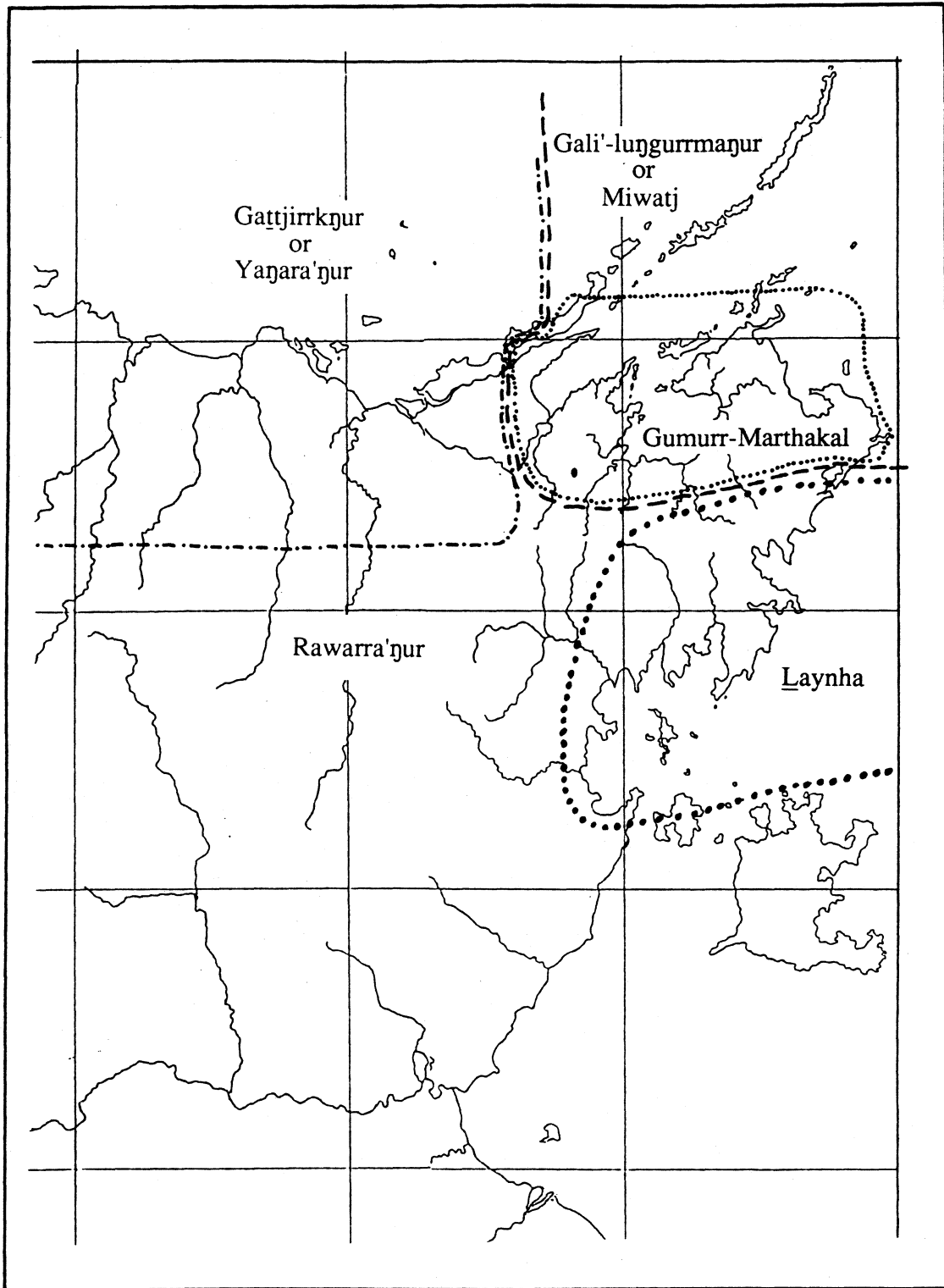

Map 1.1. Main territorial divisions of North East Arnhem Land.
(After Maratja).

the continuous feuding between clans. This continued until the 1960s when the people began to feel that their sacred sites and clan lands were being threatened by the activities of mining companies. At that point there began a move by a number of clan groups to establish what have been called homeland centres on their own land, partly in the attempt to restabilise families and partly to protect the land from other occupation by demonstrating that it was occupied in a way that white Australians could understand.

Throughout the mission period Elcho Island was unique in a number of ways. First the founding missionaries, Harold Shepherdson and his wife, had already had a long term of service in the district before setting up the mission at Elcho. They remained as the mission grew to a town, now called Galiwin'ku, and then stayed until the authority for running the town was completely transferred into Aboriginal hands. Sheppie, as he was known, was an engineer, not a clergyman, and as such sought to build an economically viable community as one of the first priorities, working on the principle that people who would not work received no hand outs. Initially he established a sawmill to produce cypress pine building timbers for Elcho and the other missions, then as staff increased, started a boat building industry, a fishing industry, extensive market gardens and an engineering workshop to support and supply all of these. His wife was in charge of the initial medical work, and started the first school at the mission.

While the Makassan contact had been an annual affair for many years it was only for a limited number of months each year and did not seriously alter the traditional lifestyle², even though a large number of Makassan words were incorporated into the language and a considerable effect has been made on content of the Yirritja Moiety ceremonial systems. With the coming of the missions there

² Throughout this thesis I use the word "traditional" to refer to practices which appear to have been active or retained from pre-mission times or prior to white contact.

began a gradually increasing change to a sedentary lifestyle, a dependence on manufactured goods and on foods that were produced by commercial means. Shepherdson saw these changes as being inevitable but encouraged people to stay on their own land. He built a plane, learned to fly, and encouraged the people to build rough airstrips at their community centres so that he could bring out to them some of the basic requirements in exchange for goods which ranged from craft work to crocodile skins. Cypress logs were also brought back to Elcho from some coastal centres by fishing boats. Thus when the movement towards re-establishing homeland centres began from the other Arnhem Land Missions there were centres all around Elcho that had never been completely unoccupied.

Shepherdson's style of government appears to have been a limited form of paternalism in that he attempted to involve senior men in the management of what might be termed aspects of the community that were outside normal Aboriginal cultural norms. With this he combined an endeavour to maintain senior Aboriginal men in positions of authority, in the aspects of community life which appeared to be relevant to Aboriginal community life³.

In 1957 the Elcho Aboriginal elders arranged what Berndt has described as an adjustment movement. This appears to have been a completely Aboriginal movement which involved the exposure of a number of ceremonial objects which it had previously been forbidden for women to see. These were cemented into what has been termed the Elcho Island Memorial (Berndt 1988:50). The apparent idea behind the action was to establish an equality between the Aboriginal and white communities and perhaps also to bridge the gaps between Christian and Aboriginal religions and between traditional and community values and life styles.

³ This was not wholly successful. Leadership of Western structures eventually fell into the hands of younger men who understood more English and had more familiarity with Western administration than the senior men (See Rudder 1979)

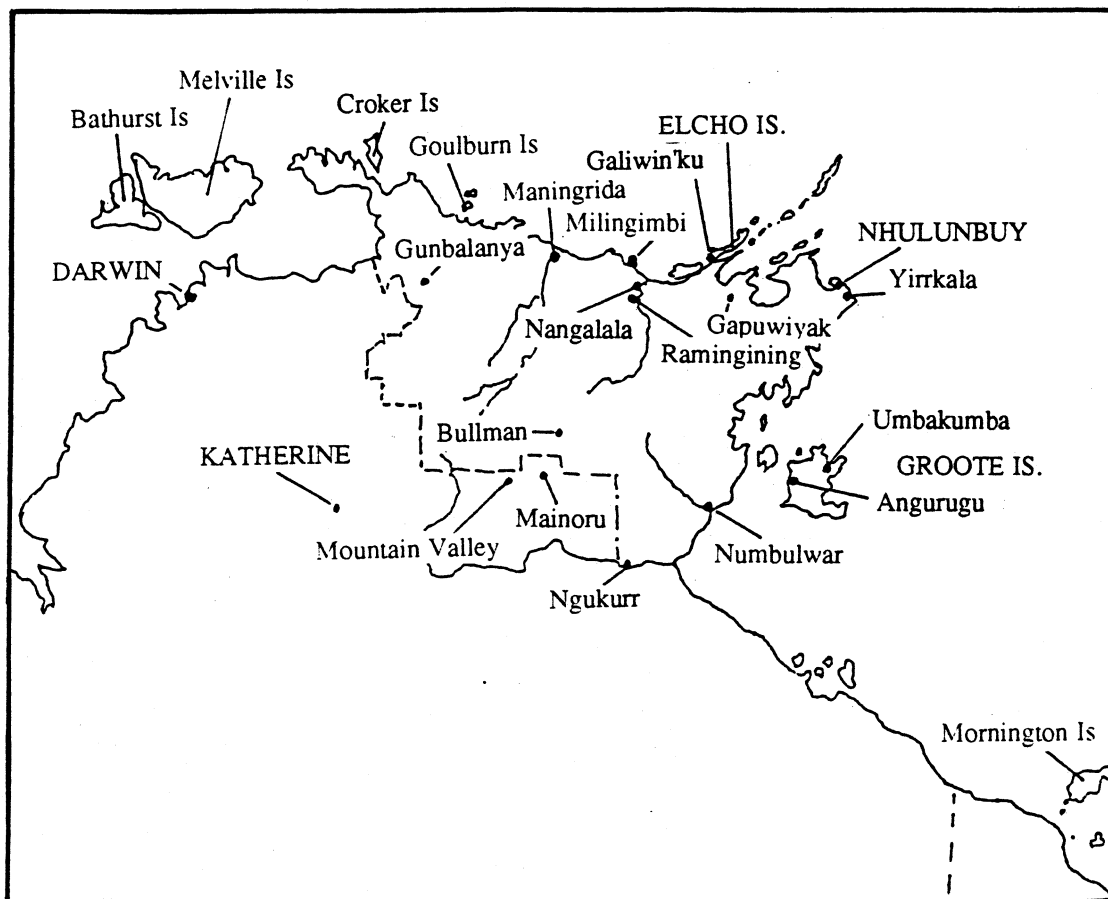

Map 1.2. Northern half of Northern Territory showing centres with which the Yolju have contact.

Since autonomous Aboriginal authority was established, there have been a number of further changes. The mission staff, recruited by the United Church, which at its highest number (including children) was over 100, has now reduced to two who work as a lay staff of the local parish under the supervision of the Aboriginal pastor. The school is staffed by government teachers, and the hospital by health department, although staff are selected by the Aboriginal council, and most other non-Aboriginal staff are employed by the Aboriginal Galiwin'ku Community Inc. Council, or the Marthakal Outstations council.

The most significant recent factor of change that I am aware of is what has been termed "The Galiwin'ku Revival". This was a movement which began spontaneously amongst the Yolŋu and has been described by Robert Bos (1987). One of the more recent outcomes of this movement has been visits by groups of Yolŋu to Israel.

Many of the issues mentioned in this brief historical overview will be dealt with more fully in later chapters, as I discuss the ways Yolŋu comprehend their world, the cosmology they have developed, and the ways in which changing circumstances have affected it. The theoretical framework of this analysis to which I now turn includes an examination of the notions of cosmos and cosmology as they are used throughout later chapters, and is followed by an introduction to some of the Yolŋu concepts critical to the later analysis.

APPROACH TO ANALYSIS.

As I have examined the questions outlined in the first paragraph of this thesis and as I have sought to learn the answers to them proposed by Yolŋu men and women, I have attempted to find a useful theoretical framework within which both analysis and discussion could be developed. This has involved a progression through a series of different anthropological approaches. The foundation for my research was laid with a combination of structural and cognitive studies. In this I

took an approach related to that described by Beals (1977:594) as he outlined what he saw as cognitive anthropology.

(S)uch differences as exist between human beings in ways of thinking or cognition are to be attributed to the kinds of information received through the senses, to the selection of information for storage in the memory, and to learned ways of processing information. Perception or the selection of information to be remembered or processed depends upon the importance attributed to particular sorts of information and upon the availability of such information within the environment. What people think and how they think about it presumably is related to the kinds of experiences they have had as members of a particular culture and as speakers of a particular language. The anthropological study of cognition has to do with the exploration of differences in ways of thinking and perceiving that are characteristic of the members of different cultures.

I examined as well as I could the ways in which Yolŋu process the "information received through the senses" and the structures used in doing this. Pursuing such a cognitive approach facilitated the analysis of classificatory and cognitive systems.⁴ However while this approach to analysis produced what appeared to be sound results, I was left with unanswered questions associated with the filters affecting the ways in which the information was being processed, and with identifying the underlying causes or patterns controlling these "differences in ways of thinking and perceiving" referred to by Beals.

Such unanswered questions led to an examination of aspects of Yolŋu semantics and symbolism and to the combination of these with structural analysis as I sought to uncover the structures of the Yolŋu symbolic systems. I considered the significance of symbolism as portrayed in some of the literature⁵ where it appeared to be argued that symbolism was the determining factor in human culture and that the symbolic codes and systems of signs once established, shaped the information that was held and the way it was added to, thus structuring the thought and hence by implication, the actions of the group. This argument, though well

⁴ After the style of Tyler (1969) Hymes (1966) Wallace (1968) and Kaplan and Manners (1972)

⁵ As for example in Dolgin (et al 1977:6)

supported, did not appear to go far enough for they gave no real basis for the analysis of how those symbolic codes came to be established. I was again left with questions as to what factors could be discovered as laying a foundation upon which such symbolic codes and systems might become established.

Thus in attempting to use each of these separate anthropological approaches, I have been pushed, by the data and these unanswered questions into a single direction. That is, to search for factors which could be considered to have shaped or to have strongly influenced the structures of the cognitive, semantic and symbolic codes by means of which the Yolŋu cosmos is constructed.

This led me finally to an examination of one aspect of analysis which is frequently referred to in the literature but which seems to have rarely been given either a central place or to have been subjected to an in depth analysis. That is, to a consideration of the place of existential presuppositions or assumptions about the nature of existence and the relationship between such presuppositions and the establishment of cultural patterns, symbolic codes and practice.

The problems associated with the place of assumptions within a cultural or social system appear to have been considered to some extent by Douglas (1973 and 1975) Ortner (1984) and Bourdieu (1977). Douglas suggests (1975:3,4) that there is some information which she refers to as "self-evident", which does not require to be justified and that remaining implicit it forms "a stable background on which more coherent meanings are formed". This information she says, is "too true to warrant discussion", and "provides the necessary unexamined assumptions upon which ordinary discourse takes place." She also suggests, with regard to these background assumptions, that it is through "these implicit channels of meaning, human society is achieved, clarity and speed of clue-reading ensured".

While examining Lele cosmology (1975:28) Douglas makes the claim that "the broad framework of assumptions about animals and humans ... are so

fundamental to Lele thought that one could almost describe them as unformulated categories through which they unconsciously organise their experiences". And again (1975:35), "Lele religion is based on certain assumptions about the inter-relation of humans, animals, and spirits". In drawing these observations together she suggests that (1975:51) "the scheme or structure of assumptions" acts as a framework for the organisation and assimilation of new experiences, with each such action serving to validate and strengthen the scheme of assumptions by which it was structured. Conversely, where an experience is unfamiliar, its accommodation may lead to the modification of the scheme of assumptions. Throughout this discussion, Douglas seems to be implying that it is on the basis of assumptions about the cosmos that the framework of perception is established and hence that assumptions play a determining role in the perception of the cosmos.

Ortner (1984:153) appears to arrive at almost the same position in discussing the relationship between practice and the "system" (which for her appears to mean the overall cultural system). She says first that,

there seems to be general agreement that action is constrained most deeply and systematically by the ways in which culture controls the definitions of the world for actors, limits their conceptual tools, and restricts their emotional repertoires.

Having then noted that the definition of the world is culturally constrained, she arrives at questions about the role of assumptions, though she phrases these somewhat differently (p155),

One question lurking behind all of this is whether in fact *all* practice, everything everybody does, embodies and hence reproduces the assumptions of the system. There is a profound philosophical issue here: how if the actors are fully cultural beings, could they ever do anything that does not in some way carry forward core cultural assumptions. On the more mundane level, the question comes down to whether divergent or nonnormative practices are simply variations upon basic cultural themes, or whether they actually imply alternative modes of social and cultural being.

She suggests that where change occurs as a result of class struggle and a different group assumes dominance, that change is related to a difference in the "ways of seeing and organising the world" which are associated with the new

dominant group. Her use of "ways of seeing and organising the world" and her "system" and "culture" appear to mean very much the same thing as each other and to be very close to my own definition of "cosmology" outlined in the section which follows this. However in her questioning about the relations between practice and the assumptions of the systems she is raising not one question, but by implication, a series of them. These can be phrased as follows;

What is the relation between system, practice and assumption?

Do assumptions play a determining role?

Is variation in practice possible without variation in assumptions?

Does a change in assumption impose a change in practice or in the system?

Within these questions there is Ortner's own assumption that there is something that is agreed upon in common by a whole group of people which is a manifestation of their group identity. In this case Ortner is specifically referring to a "system" which incorporates a set of assumptions and this is very close to if not the same as the conclusion reached by Douglas, both discussions at one point being able to be reduced to the considerations of the relationships between a set of assumptions corporately held and a world which is to some extent at least, corporately perceived.

In the development of his theory of practice, Bourdieu (1977) appears to come close to these same questions. He introduces two terms, habitus and doxa, linking each of them to elements that he describes as "taken for granted". Because this phrase can be used to mean "assumption" or "presupposition" it would be a simple matter to conclude that he is considering the same things as I am in his use of these terms. However habitus as he defines it is a strategy generating principle almost indistinguishable from ethos, but which he says is developed as a habitual pattern of responding to various situations out of a history of pragmatic choices of action to gain optimum advantage. This habitus once formed is then described as

being a disposition or inclination to act in a particular way (p214) and as taking a determining role in the way members of a group respond to situations (p76-78). It is "taken for granted" as the right way to respond to a situation, that is, based on assumptions about the most effective ways to act to achieve the desired results. Thus the "taken for granted" associated with habitus are assumptions associated with a group's characteristic responses to situations, that is, their practice and are not primarily assumptions associated with the nature of the group or the nature of its world.

Bourdieu (1977:164) continuing his discussion, identifies a second "taken for granted" by the term "doxa". This he refers to as the "taken for granted" nature of the naturalness (and hence rightness) of the structures of social relations of dominance, in which the dominating and dominated groups accept these structures without consideration that there could be an alternative. This relationship he says, is supported by the structures of the natural world as it is perceived and as it appears to parallel and prove the naturalness or rightness of the relations between humans. This is his doxic relationship where the assumptions that he is considering are those associated with the practices, and with the unchallenged and unchallengeable structures of dominance involved in those practices.

Thus doxa as a term identifies one particular kind or category of **existential assumption**; that associated with the nature of the structures of the **relations of dominance** in any particular society. As such I consider it to be focussed on a narrow domain as far as existential assumptions are concerned being restricted to only one aspect of the presuppositions about the nature of the cosmos, and I will only consider it incidently to the main direction of this thesis.

There is a distinction between core and non-core assumptions that is implied in the problem raised by Ortner though not explicitly stated. In considering the second half of the problem she raised, of whether there are possibilities of alternatives modes within a single culture or whether such an alternative mode is to

be considered as non-normative appears to me to be related to whether such non-normative practices are related to a change in the core assumptions or not. Ortner raises this issue again (1984:14) without offering a solution, when she says that

the central problem for practice theory is, as all its practitioners seem to agree, precisely the question of how actors who are so much products of their own social and cultural context can ever come to transform the conditions of their own existence, except by accident.

There is then a further problem associated with the relationship between assumptions and other aspects of a cultural system where a situation of change occurs, which can be formulated in the question, "Does a change in the environment cause a change in either cosmological assumptions or in the perception of the cosmos, and if so how?" This is a problem for which I do not have adequate space in this thesis to give a thorough examination, though I will touch it briefly in later discussion.

Chalmers (1976:92) attempts to give an answer to such a question in a discussion of Thomas Kuhn's (1962/70) work, suggesting that there is a relationship between a change in assumption and a change in practice, which involves a radical "conversion" type experience.

The change of allegiance on the part of individual scientists from one paradigm to an incompatible alternative is likened by Kuhn [1970] to a 'gestalt switch' or a 'religious conversion.'

Douglas has suggested (1975:76) that paradigm is "Kuhn's expression for a set of scientific assumptions based on a crucial well-established piece of research" This being so it is possible to interpret Kuhn as arguing that a change in cosmological assumption requires an experience that conflicts radically with those assumptions to the point where those assumptions are no longer compatible with experience and are radically changed. This would agree with Chalmer's further suggestion (1976:92) that,

There will be no purely logical argument that demonstrates the superiority of one paradigm over another and that thereby compels a rational scientist to make the change. [From one to another].

The relationship between such paradigm change and this "gestalt switch" or "religious conversion" will be indicated briefly later in this thesis, together with the relation between such changes and core assumptions, which from this point on I will refer to as presuppositions. It is necessary first however to consider the relation between these things and "Yolju cosmology" which forms the focus of this thesis.

COSMOLOGY, WORLD VIEW AND CHANGE.

I have taken as a basic definition of cosmology a combination of those given by the Encyclopaedia Britannica and the Oxford English Dictionary. The definition given by the Dictionary says that cosmology is

the science or theory of the universe as an ordered whole, and of the general laws which govern it. Also a particular account or system of the universe and its laws.

This is a definition which relates very closely to Chalmer's use of "theory" in his discussion of the theory of science (1976). The Encyclopaedia describes cosmology as

that framework of concepts and relations which man erects, in satisfaction of some emotional or intellectual drive, for the purpose of bringing descriptive order into the world as a whole, including himself as one of the elements.

By combining these definitions with an acknowledgement that cosmology is a human construction, the definition that develops is broad but practical. That is, **Cosmology is the theory of the universe as an ordered whole, including the framework of concepts and relations which man erects, for the purpose of bringing descriptive order into the world as a whole, including himself as one of the elements.** In developing the definition in this form I have incorporated the understanding, common throughout anthropological literature that the cosmos, the totality in which man exists and of which he is a part, is not interpreted in the same way by all human groups, but that the many different interpretations lead to a variety of cosmologies or theories of the nature of that which is. Thus the universe

which is perceived and interpreted by any particular group is a human construction which is specific to that group.

Various academic disciplines tend to treat the subject of cosmology somewhat differently from the dictionary and encyclopaedia definitions. Astronomers appear to understand it as a study of the physical bodies of space and the relations between them. Historians appear to focus particularly on the aspects of religion and mythology; as Bolle (1987:100) says,

For historians, including historians of religion, the study of cosmology surveys and tries to classify and understand the significance of mythical images and religious conceptions concerning the cosmos and the origin and structure of the universe

Frequently this focussing of cosmology on religion or ritual has also been a feature of anthropological approaches to the subject. For example, Munn (1964) and Goodenough (1986) treat the interpretation of cosmology as a given associated with religious concepts but do not attempt to define it. However, irrespective of whether a particular study focusses on a single aspect of a society, and whether or not it focusses on religion or the physical bodies of space, it appears that any of these diverse approaches can be considered as relating to particular aspects of the definition as I have outlined it above.

Within the anthropological literature the content of material referred to by my definition of cosmology is frequently described as world view. Some writers, for example Douglas (1973) use the terms interchangeably. Others argue for the use of one term or the other and Jones (1972) Leichtman (1972) Nelson (1972) and Ong (1972) participants in a 1968 conference on world view, demonstrated clearly that there was no real agreement as to what the domain of meaning of "world view" was, each attempting to establish his own definition of it.

Kearney attempted to make an appraisal of the available literature on world view and appeared to conclude that there had been no generally accepted approach. He then proposed yet another approach (1975:247) wherein he took

world view to be virtually synonymous with cognitive anthropology in the basic sense of cognition indicated in its etymology to get a knowledge of .

This he argued was different from what is normally considered as cognitive anthropology which he summed up as a combination of ethnoscience and ethnosemantics. World view, he suggested, differed from this in three significant ways. First it "makes heavy use of non-verbal behavior." Secondly, traditional ethnosemantics were limited to a narrow concern with folk taxonomies. His third distinction which he raised in a discussion of Douglas (1973:254) presented world view as "concerned with the underlying implicit assumptions about such things as causality, time or human nature" in contrast to the normal variety of ethnoscience, which he said, did not.

My own definition of cosmology incorporates Kearney's "world view" and both the versions of cognitive anthropology that he distinguishes. However it separates from cosmology, presuppositions about the nature of existence. These I consider to be an essential ingredient in the study or analysis of a particular cosmology, but able to be distinguished from it in such a way that the relations between the two can be examined. Douglas while considering cosmologies or world views as types of theories suggests that (1973:173)

Each theory has its hidden implications. These are its unspoken assumptions about the nature of ultimate reality. They are unspoken because they are taken for granted. There is no need to make them explicit because this is the common basis of experience. Such shared assumptions underlie any discourse, even the elaborated speech code which is developed to inspect them. They are the foundations on which social reality is constituted as the phenomenologists point out.

She does not, as Kearney appears to suggest, explicitly incorporate assumption as part of a world view theory. Such existential presuppositions or assumptions, according to this view, function at a more foundational level than the cosmological theories which appear to be constructed on them. That is to say, that which is "taken for granted", or presumed about the nature of existence forms a basis upon which understandings of the cosmos are constructed.

I have, in agreement with Douglas' distinction, separated cosmological presuppositions from cosmological theories on the grounds that these appear to function at two distinct levels. Douglas (1973:179) asserts of cosmology that cosmological theories appear to be consistently subject to change;

Anyone who finds himself living in a new social condition must
... find that the cosmology he used in his old habitat no longer works. We should try to think of cosmology as a set of categories that are in use. It is like lenses which bring into focus and make bearable the manifold challenge of experience. It is not a hard carapace which the tortoise has to carry for ever, but something very flexible and easily disjointed. Spare parts can be fitted and adjustments made without much trouble.

I will attempt to show that the data collected at Elcho Island and other centres in North East Arnhem Land indicate that most of the changes which have been and which continuously are being developed in cosmology appear to be occurring at the level of cosmological theory rather than at the level of presupposition. Throughout my analysis as I attempt to show the relationships between cosmology and the presuppositions upon which it is established, I will also attempt to demonstrate that where the cosmology is changing, some at least of the foundational level presuppositions appear to maintain their integrity, remaining unchanged through the changing circumstances. This of itself would appear to indicate support for the suggestion that they function on a different level from the normal cosmological theory and in fact enable the maintenance of a stable framework upon which theory may be built, altered or replaced in relation to changing circumstances.

Since Warner (1937/58) produced his wide ranging ethnography of the "Murngin" as he called the Yolŋu, anthropologists, appear to have concentrated on particular aspects of Yolŋu society. By taking this approach, each researcher has been able to produce more in depth analyses of the areas of their choice than could otherwise be achieved. At the same time each appears to be aware that while gaining more in depth in the field of their specialisation, each work produces only a partial understanding of the overall Yolŋu society.

The task I have set myself is similarly partial in that while I have attempted to achieve a satisfactory level of analysis in each of the domains of Yolŋu society that I discuss, my overall aim is not to pursue each to its ultimate analysis but to attempt to examine the relationships between these domains for the overall coherence which will by that very coherence produce a more sustainable analysis of Yolŋu cosmology. At a simplistic level it could be said that what I have set out to research is those structures in the mind which the Yolŋu use,^{5b} not only in their explication of the cosmos that is, but in their interaction with and control of it.

In this I am indebted to other ethnographers for their contributions in the particular areas covered by the different chapters of this thesis. For the main part I have referred to these in the chapters where their work is of most relevance to my own, however I need to make some general reference here to the areas in which they have made contributions that are relevant to my overall theme. In particular there are nine writers whose work has made important contributions. These are, in a semi-historic order, Warner, Thomson and Berndt, who laid foundations for later anthropologists, and Shapiro, Peterson, Williams, Morphy, Reid and Keen who have contributed in depth analyses of particular aspects of North East Arnhem Land life and thought.

I have had particular recourse to Berndt, Shapiro, Peterson, Morphy and Keen in the analysis of kinship and family as I have sought to show the integration between these and cosmology. All nine of the writers have been important in their contributions to my own understandings of Yolŋu religion and to the conceptualisation of space. Only Berndt and Warner appear to have published material on the Morning Star complex, this being in the form of recorded myths. The ethnography of time herein is entirely based on my own research apart from contributions made by the three linguists referred to in the chapter. The ways in which I am indebted to these predecessors will be made explicit as I refer to their work in later sections.

SOME YOLŊU CONCEPTS.

I have taken the approach that to reach an interpretation of the Yolŋu cosmology which is in any way related to their understanding of it, it is necessary to listen to their own ideas of the cosmos, how they perceive it, how they structure it, and what the focus of their thought is in their perceptions of it. While this to a certain extent has to be done in terms of western categories, which form the foundation of our English language, I have attempted to avoid the imposition of these wherever possible and to avoid also interpreting either their cosmos or cosmology as if it was simply a variation of some one or other of the cosmologies of other peoples described in the anthropological literature.

It appears that at least in Western cosmologies, and there appear to be a range of these, the focus of attention is upon such ideas as time, space and material substance structured in terms of linear continua and quantitative measurement, with the addition in some cases at least of some perceptions of a spiritual, supernatural or metaphysical dimension. Most such cosmologies can then be explained through reference to understandings of these things.

The Yolŋu cosmos is neither linear nor quantitative so some difficulty occurs in attempting to describe it as far as finding an adequate place to start, for the approach to it taken by the Yolŋu, and the thought patterns used by them in assessing it appear radically different from Western ones.

By way of introduction to such differences, I have chosen in the sections which follow to introduce five Yolŋu concepts, an understanding of which is essential for the discussions which follow. The first of the five is that of the network of relationships. Associated with its use are the other concepts; focus, identity, transformation, and the notion of inside and outside, all of which need some initial explanation, but will be developed further in later chapters.

Networks of Relationships

On one occasion, as I was bemoaning the difficulty of explaining the Yolŋu perception of the cosmos, Djirrimbilpilywuy said to me, "Why don't you use the word 'network'?" With acknowledgement to him, I have chosen to use his term as a foundation upon which to build description. In the choice of the word "network" as a term to describe the overall cosmos, and in the development and description of the other associated concepts, it should be pointed out initially that these are of necessity explanations in English of concepts in Yolŋu language. While the concepts are transferable between the two, for the most part the terms chosen in English are not translations of single Yolŋu terms. They, together with the explanations of their particular useage in the thesis, have been chosen as the most precise communication of the Yolŋu concepts that I have been able to achieve.⁶

The choice of the term "network" becomes more significant when considered in terms of its derivation from "net". One can think of a net as being constructed by connecting strings at particular points or by connecting a series of points together with strings. This is particularly appropriate in the Yolŋu situation where the connections seen to exist between Yolŋu individuals and groups are often referred to as strings. This is especially so where these are ceremonially based relationships, as these are frequently represented by hand made strings of a variety of different types .

The idea of string as signifying relationship connections is used throughout the Yolŋu world. One good example of this can be found in the ritualised way a man may use a string to indicate choice concerning his relationship

⁶ There are several aspects of the word "network" which make it an appropriate descriptive term. Both a net and a network can be considered to be composed of a series of interconnected points. However while a net tends to be based on regularity and is largely constructed in a single plane, a network has considerable variation in the spacing between connected points and is potentially multi-dimensional.

with a woman. As this was explained to me by Djorrrpum, an old man now deceased, a man may hear that a woman, promised to him as a wife, no longer desires to come to him, or that she has been taken by another man. He will take a length of a particular kind of string, tie it between two uprights (e.g. two trees) and sit beneath it. There he waits and decides his response to the situation perhaps taking several days to do so. His decision is then indicated using the string. If he cuts it, he is signifying that the relationship between them, represented by the string connecting the uprights, no longer exists. If he leaves the string where it is, he is signifying that the connection has been made and will continue. He will then gather up his spears, and go and get her. In this process the connection made by the string between two uprights is used as a clear statement of the relationship or severance of relationship between two individuals.

"Relationship" as it is used in the following descriptions, carries with it the implication of a formally structured relationship with established patterns of behaviour recognised as existing and appropriate between whatever or whoever is connected by the establishment of that relationship. For the most part these patterns are perceived in terms of human relationships, each couplet of which is seen to have an appropriate reciprocal behaviour pattern.

Identity

When I asked Rrurrambu, one of the the Yolŋu leaders, the question, "What is it that is of the most value to the Yolŋu people?" His very succinct reply, which included both an answer and a definition of it was, "Knowing identity -where I fit, what and who I am". This answer with equal accuracy can be rendered as, "knowing my identity, knowing my relationships, knowing that which gives meaning to my life."

Much care has been, and continuously is expended by the Yolŋu on the recognition of, classification of, and naming of identities, and the establishment of

the relationships between identities. This is a different process from the Western model of identifying things. Particular attention is given by the Yolŋu to the relationships between groups and between individual humans, between humans and other species and between humans and land because it is on the basis of these sets of relationships that identity is established and verified.⁷

Where I use the word "identity", I am using it in this wider sense, so that any named element or entity within the Yolŋu cosmos can be considered as having an identity, or more precisely from a Yolŋu perspective, "being an identity"⁸. Used in this way, an identity can be any object or any intangible entity and represented by its name. Each thing is, assumed to "have" an identity and a set of relationships by which its identity is defined, even when neither identity nor relationships have been established. That is, all things found to exist are assumed to have an identity and hence an appropriate set of relationships by which that identity is defined, even if these details are not known.⁹

As far as the affective aspects of identity are concerned (that is, whether a person might be described as angry, violent or quiet) I have separated these from the description of identity in this introduction, considering them as aspects of a person's nature rather than of their identity in the terms that I have been discussing. Such a separation is admittedly somewhat pedantic and the two aspects of the individual are drawn together in later discussion.

In using the term, I am referring to all the entities perceived to exist or to potentially exist in both the physical and non-physical worlds. Thus, it is possible to speak of the identity of individuals, but also corporate identities, the

⁷ These sets of relationships are discussed more fully in Chapter 4.

⁸ This poses some logical difficulties at this introductory level of explanation. However as the discussion of basic concepts continues these will be resolved. The main solution lies in the concepts of inside and outside which are yet to be considered.

⁹ Often with living things, a relationship will be given between the item being referred to and some other element of the cosmos. For example, I had an unnamed water plant referred to as "waterlily's grandmother".

identities of the varied elements of the world and the identities of the supernatural and mythological beings, as well as the identities of plants, animals and any relevant substances.

Focus.

The concept of focus has two distinct applications. When the notion of "identity" is linked to that of "network", an identity can be considered as functioning as one of the nodes or points to which a set of relationships is attached. The identity of that particular item is then established through the set of relationships which connect it to other elements of the cosmos. When this occurs, the process of determining or establishing an identity can be described as being determined by evaluating the conjunction or focussing of a set of relationships. This is the first application I have made of the concept of focus. That is, as the point where a set of relationships come together. Thus identity can in this sense be said to be determined as the focus of a set of related points.

If we are to comprehend the wider scope of the Yolŋu perceptions of the nature of "identity" then an understanding of a second sense of the term "focus" is critical. This second sense was first made clear to me by Mick Daypurryun, a senior man of the Liya-gawumirr clan. At the time, we were mapping the places of significance on the south-western coastline of Elcho Island (see Map 5.5.), an area for which his clan is a custodian, and I had been trying to establish the location of the boundaries between two named areas. As we stood on the beach he poked a hole in the sand with the stick he was carrying. "That", he said, "Is the rock where *ḡatili* (black cockatoo) sat down. We call it '*Nḡatili nhinan*' (black cockatoo sat down)". (This rock was one we had just marked on the map, a large rock which stood in the inter-tidal zone on the beach.) Daypurryun then drew around it an oval shape which included the "rock" at one end of it. He explained that this was the area around the rock, which included part of the beach and part of the open Eucalyptus forest behind the beach. This area represented by the oval around the

rock was also called '*N̄atili nhinan*'. A line was drawn across the oval to represent the junction between the beach, and the bush behind it. Land adjacent to the oval could be considered as being related to it so that there was a still larger area outside the oval which could also be called by the same name.

In this brief period of instruction Daypurryun demonstrated that identity, and the establishment of identity in the naming of sites in Yolŋu thought are based on focus and relationships, and not on boundary¹⁰. In this case the identity of areas of land that we were marking on the map depended on the relationship between the area being identified and the most prominent adjacent focus of significance. The rock itself was '*N̄atili nhinan*'. Any area adjacent to it was also automatically identified with it and therefore also '*N̄atili nhinan*'. Further away from the adjacent area, the identification of a site of land depended on its proximity to (or relationship to) named focal sites. As we continued with the mapping of the stretch of coastline it became apparent that when we were at some distance from any significant site, the naming of an area of land was then potentially open to choice, as the area was in a vague relationship to two sites and either of these could be considered as a choice for naming the location, depending on the context at a particular time. The relation between two adjacent focal sites is illustrated in Figure 1.1; the land between the two focal points being potentially able to be related to either, depending on the concern at the time of identification. There was no precise border between the two.

This idea of focus presents a major contrast between Yolŋu and Western notions of identity. Western thought strives to establish the identity of a plot of land by putting a boundary around the area. All that lies within the boundary is then equally of the same identity. The Yolŋu use of relationship to a focal point, produces an identification which is relative in intensity according to the

¹⁰ A fuller examination of this contrast between focus and boundary is undertaken in a later chapter on concepts of space (Chapter 5).

perceived proximity to its focus. Where Westerners are most likely to establish a boundary, the Yolŋu are least likely to do so, for at that location, identification is least certain and most open to re-evaluation.¹¹

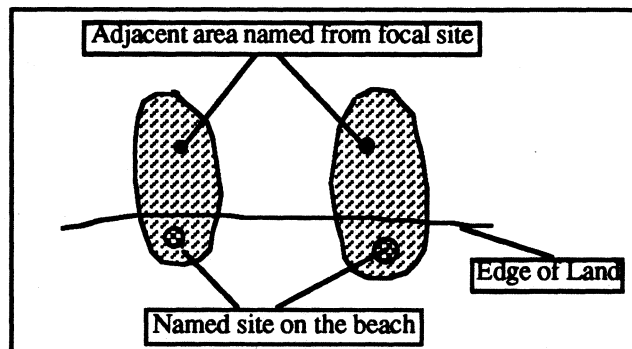

Figure 1.1. System of naming areas on basis of significant focal points. (After Mick Daypurryun).

This notion of identity and the establishment of identity as being based on the relationship to (or relativity to) a focus, can be demonstrated in a wide variety of classificatory systems. Identification, and hence the defining of identity, is carried out in terms of relationship to a series of foci which are presumed to be permanently identified and unchanging in nature. Thus the identifying of a colour is relative to its proximity, in terms of three categories of colour saturation, to one of the set of colour foci in a way analogous to the way in which the identifying and naming of any area of land is relative to its proximity to named points or features. These applications of focus can be generalised to say that the determination of the identity of anything is dependant upon the perceived connection (or relationship) between that item and existing, recognised focal points. In line with this, it is possible to project the implication that the strength or clarity of identity is relative to the strength of connection to (or closeness to or relationship with) a particular focus, an aspect that will be seen to be very significant in later discussion of human

¹¹ But see further discussion of the establishment of boundaries in Chapter 5.

identity. The corollary of this is that if a thing (or a person) has no connection with anything of significance, then it (or they) lack identity and are therefore irrelevant.¹²

Because of the way in which the identity of anything is defined in terms of its relationship to other elements of the cosmos, it is extremely difficult if not impossible to take any single element of the Yolŋu cosmos and examine it in isolation. No part of the cosmos exists in isolation but all are related in many directions to other parts. Each specific identified element becomes the focus of a set of relationships which links other elements as part of the overall network; each of these in turn links to other elements and this pattern of interrelated elements continues without boundaries or limits. One result of this is that the whole cosmos becomes a single unbounded network of of inter-related elements. Simply by definition it is impossible to describe it comprehensively (i.e. one cannot encompass the parameter of an unbounded entity). This then brings us to a preliminary working definition of the Yolŋu cosmos wherein it can be defined as an unbounded network of identities in relationship to each other. Yolŋu cosmology becomes then an application of this perception.

Change and Transformation

It is important to recognise at this point a distinction between an identity and an individual. The individual is seen as having an identity which may be focussed differently in different contexts, and it is that identity which is seen as being unchanging. Two things are observed as changing, the external appearances of individuals (or discrete elements of the cosmos) and the relationships between them.¹³

¹² Thus, for example, any visiting white people are only of relevance to the community if they have connections with people of already established relationships.

¹³ In the sense of the increasing complexity of relationships.

While the individual is observed to change, this change is considered in terms of transformation of the outward expression of an unchanging identity. Such change as does occur is then able to be considered as an expression of a part of the identity that has until that point, been dormant. Some, though not all identities are seen as going through an identified series of transformations of outer form, while their inner nature is seen as unchanging. The stages of transformation are considered in relation to one another as different expressions of single identities. There are two different types of transformation with classified stages. The first type appears to be considered as a series of transformations in a single direction, each successive stage being a more complete expression of identity than the preceding one.¹⁴ The second type of transformation involves movement in and out of expression in a known repeating pattern but also in a single direction.¹⁵ In both types there is a consistent pattern in the stages of transformation and there is a wide range of identities which are seen as going through such series of recognised stages.

With transformations occurring in the relationships between these unchanging identities, it is in these transformations and their manipulation that the foundation of Yolŋu politics lies. The notion of the establishment of relations to form connections to one's own advantage is constantly being employed in the complex domain of Yolŋu politics. The notions of power and of identity are closely linked to each other, and to the notions of closeness of relationship to, and authority concerning focal points of ceremonial significance (whatever forms these points may take). The establishment of position, and hence of identity in regard to these nodes is facilitated by the relativity of relationship and the potential for the application of pressure within the wholly flexible unbounded system. In this way some aspects of transformation at least are considered as being able to be

¹⁴ For example, the progress of animals and humans through recognised life stages. (See chapter 3).

¹⁵ For example the continuous reappearance of seasons. (See Chapter 6).

controlled. Much political manoeuvring is then based on the manipulation of the degree of proximity to the nodes, through assertion and counter-assertion.

Inside and Outside.

There appear to be two aspects to every identity, an "outside" (*warragul*) aspect and an "inside" (*djinawa*) aspect. However the use of these two terms is spread over a wide field of meaning. One aspect of this spread may be able to be interpreted as the contrast between the physical body and the emotions, although in the following extract from his Sunday morning sermon Daṅataṅa, an experienced health worker, was referring to more than the emotions,

I can help if he is hurt with a spear or a gun shot. That's the outside that's hurt, but I can't help if hurt on the inside. Only Jesus can see the inside and help him on the inside

Some things are thought of as "outside" though they have an inside aspect, others appear to be almost exclusively "inside" while potentially at least having "outside" aspects. Those things that are "outside" are in the open where they may be handled, or at least seen by all, including women and children. "Inside" at one polarity of its usage refers to those things of a secret / sacred nature¹⁶ which in most cases can only be seen by men or touched by men. When used this way the word is interchangeable with *maḍayin* (secret/sacred things) as shown in a brief quote from Bapawun who made the observation that

Baṅumbirr is "outsidepuy" (belonging to the outside) *yaka maḍayin* (not sacred) *miyalk ga djamarrkuli* (women and children) watch..

This aspect was emphasised by Rrurrambu, who in defining it said,

Djinawa is also called *dandja*. It is very secret things not to be known. It concerns the stuff that is passed on through some of the family line. *Bāpa dhu gurrupan* (the father will give) only to those who he sees will treat it with respect.

¹⁶ It is this sense which is largely the focus of Morphy's discussion of the two terms (1991:75-99) though he does intimate a wider usage without expanding on it in detail.

There is no clear boundary between inside and outside existence and there is passage between the two in either direction by the previously discussed process of transformation. There is also overlap between them, so as a result anything in the outside can be thought of as having inside attributes. For example, a single entity may have some meanings that are inside and some that are outside. Similarly it would appear that potentially at least, anything of the inside can have outside transformations which can be touched and experienced such as the animal form of some "totems". In some ways this contrast appears to be similar to that between the notions of "sacred" and "profane", however as I will show in later chapters, there are aspects of the contrasts that would be lost if restricted to this dichotomy.

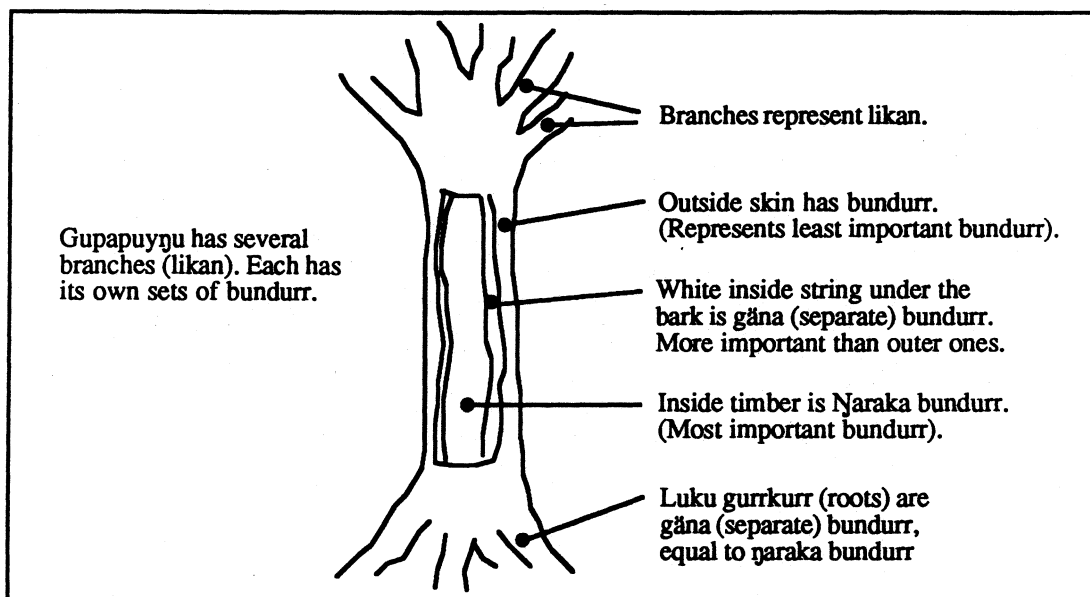

Figure 1.2. The relationships between different levels of insideness or outsideness of ritual invocations. (After sketch drawn by Brian Djangirrawuy).

There are degrees of insideness, and more significant things may be referred to in English as being "deeper" inside, "more deeper" or "more inside", and there are terms used in the categorisation of such levels of insideness which will be discussed in later sections of the thesis. Djangirrawuy, in an attempt to describe this notion, drew a visual analogue of it in terms of the structure of a tree.

This, represented by Figure 1.2, was based on the degrees of insideness of ritual invocations (*bundurr*) The significance of the analogue and of the terms used will become more apparent in later discussion.

In the more general sense "inside" has a much wider potential in terms of its use in regard to cosmological assumptions. As all that has an identity, is perceived to have a continuing existence, "inside", is where all things which have been previously experienced as "outside" have their continuing existence. Similarly, by implication, all new things which come to be experienced, must have existed previously, so by virtue of their being experienced, must have been either "inside" or somewhere else "outside" prior to their being experienced.

THE SIGNIFICANCE OF LAND AND SACREDNESS IN IDENTITY.

A further result of the cosmos being "an unbounded network of unchanging identities in flexible relationships", is that the whole society, so to speak, is afloat on a sea of relativity, where every classification or evaluation, is relative to every other one and to every other context of evaluation. The society according to this is potentially adrift without any secure base, so insecurity ought to be the order of the day. However in the Yolŋu cosmos, the *maḍayin*, (sacred elements of the religion), and in particular the *raṅga* (sacred ceremonial objects) function as anchors to hold the whole fluid cosmological network stable, by fixing it to the network of sacred sites which are spread across the land. This is one major reason for these sites and objects having so much importance to Aboriginal society.¹⁷

A further significance of the *raṅga* (ritual items) is that they are tangible representations of the inside aspects of identity. As one man said to me it

¹⁷ And for the Yolŋu also, focus on location of events rather than their time of occurrence (See Chapter 6).

is not the wooden objects that are of the greatest significance but the invisible identity that they represent, or, as he put it, "You look at the sacred object, It represents the *ranga*, but you can't see it, only the object". Another basis of the power of the *ranga* in relation to identity is that they represent an identity which in its various transformations cross-cuts the different dimensions of existence. For example, assuming that part of your identity is snake, it can be represented in the form of a snake *ranga*, or in a different transformation, it can appear as a living snake to your parents before birth, indicating your identity, (and incidently your mother's pregnancy with you)¹⁸. There is tangible physical evidence of the ancestral snake in the physical stuff left behind by it at your sacred site, which may take the form of particular rocks or a watercourse, a tree, or even the hole or waterhole that the ancestor went into in its/his transformation from the physical snake form of its manifestation. The occurrence which happened in "other" space and "other" time is simultaneously present through the different physical manifestations in current time as well as within the individual. At times of ceremonial, when the sacred objects are refurbished, for at least some Yolŋu, the ancestral being becomes actually present (Berndt 1948:311) and that presence may be recognised in a spiritual experience. Hence through the apprehension of this multiple manifestation of the entity and its affiliation with land, and therefore of your own identity across dimensions, personal stability is achieved and through this security is facilitated.

APPROACH TO DESCRIPTION.

Because each element of the Yolŋu cosmos is identified by its position in relation to other elements, the identity of each aspect of the cosmos is then structured similarly (analogously) to every other part, a description of the cosmos can begin at any point and move at random in any direction. I have chosen to begin

¹⁸ See Chapters 2 and 3.

with considerations of the Yolŋu notions of identity in terms of the non-physical or supernatural aspects of the cosmos. With this being established as a foundation, each of the succeeding chapters will then concentrate around a single focus and follow the connections outward from it to demonstrate its relationship to the structure of the overall cosmos. The two chapters which follow this are concerned with the place of the Yolŋu within their cosmos. One of these considers the transformations through which a person passes during a lifespan, the other concentrates on the human person, as an individual in a network of human relationships¹⁹.

Two chapters discuss aspects which appear to be traditional in at least some descriptions of cosmologies, that is, those associated with space and with time. Description of the concepts of space and of the land, show that the land forms a relatively stable basis to which man relates and to which the other aspects of the cosmos can be related. Yolŋu time concepts are considered in detail in an attempt to solve the problems of what has been an area of anthropological enquiry fraught with misconceptions and argument. I discuss the Yolŋu notions of duration and the place within these concepts of the idea of The Dreaming (Stanner) in relation to Yolŋu existential presuppositions.

Chapter 7 is concerned with Baṅumbirr, which is the Yolŋu name for the Morning Star. Linked to this is a composite of myth and ritual, meanings and relationships, which spreads across the entire Yolŋu territory. I refer to this composite with its various extensions and relationships as the Baṅumbirr Complex. There are a number of reasons for its choice for description. Firstly, while the complex is a small section of the cosmos, yet it forms an example of the cosmos in miniature. Therefore, what can be drawn from it is exemplary of the overall cosmos. Next, and of major significance in the choice is the fact that the ritual

¹⁹ That is, one deals with diachronic relations and the other with synchronic relations.

objects have been explicitly described to me as being non-sacred²⁰. This means that the exposition is less fraught with the difficulties involved with the open discussion of secret-sacred materials. Finally there is the availability of a wide range of data, some I have personally collected, some that has been published, and some that is unpublished but recorded in archives, museums and galleries around the country.

The conclusion of the thesis incorporates an analysis of the elements of the Banumbirr complex, a summary of cosmological presuppositions which form the foundations of the cosmology, and a drawing together of the threads developed through the body of the thesis.

In the process of working through the different subject areas, I will also demonstrate that there are at least two levels on which the cosmos can be examined; a superficial one which is constantly open to change, and an inner one (using the word "inner" here in a Yolŋu sense) which is capable of incorporating change while remaining constant.

It is my intention by the end of this thesis to have demonstrated that the Yolŋu Cosmos is a viable and living structure, which while as the Yolŋu say of it that it "is unchanging" yet it is capable within that "unchangingness", of constant adaptation to changing circumstances and experiences while at the same time providing stability and a secure perception of identity through that change.

²⁰ See earlier quote from Bapawun.

CHAPTER 2. THE ETERNAL COSMOS.

INTRODUCTION.

MANIFESTATIONS OF THE INSIDE OF REALITY.

"Children".

Mokuy.

Birrimbirr.

Totems.

Waṅarr, The Ancestral Beings.

The Djaṅ'kawu myth.

The Wäwilak Myth.

Barama, Lany'tjun, Galparrimun.

Traces.

The Holy Spirit.

TAPPING POWER.

Marrṅgitj .

Galka

Nyera .

Substances Used in Tapping Power.

Ancestral Power.

RELATIONS WITH THE INSIDE OF REALITY

THROUGH THE RELIGIOUS SYSTEM

Vehicles of Religious Knowledge.

Myth as a vehicle for recording the establishment and maintenance of relations between groups.

Analogue as a vehicle for the control of Religious Knowledge.

Control of Religious Knowledge.

THE TWO REVIVALS.

CONCLUSIONS.

THE ETERNAL COSMOS.

INTRODUCTION.

In the same way that any "identity" can be thought of as having an "inside" and an "outside" aspect, the Yolŋu cosmos can be considered as a single reality with two sides, one side of which is subject to transformation, while the other remains unchanging. It is too simplistic to separate these as physical and spiritual worlds and I have chosen to follow the Yolŋu practice and describe one as the outside or the outside of reality and the other as the inside or the inside of reality. The eternal cosmos, the focus of this chapter, is an inner reality which is potentially both the source and the destiny of everything in the outer reality of human experience. It is a kind of parallel existence with a different quality in which everything is equivalent to, analogous to, or a transformation of the outer reality. Put the other way around it would appear to be truer of Yolŋu ways of referring to the "inside" to treat it as the original template of which everything "outside" is equivalent to, analogous to, or a transformation of it.

Knowledge is experiential, that is to say, to know something is to have had an experience of it. For example, a person who has taken one puff on a pipe has experienced tobacco, so knows tobacco. Similarly knowledge of the "inside" is experiential. Existence of the eternal cosmos is unquestioned as it is demonstrated through historic contact at known places, and this contact is demonstrated by the traces or transformations left behind in the landscape by beings of various kinds who have come from the inside reality. The actions of these beings, men and ancestors at known places are recorded in terms of narratives, and in the song-poetry, dance, and two and three dimensional representations which were left behind by them, and men experience going "inside" when they are involved in "inside" ceremonies.

Man's knowledge of the inner side of reality is not total because no-one knows all, and there is always more to be known. With the presupposition of

changelessness in the inner reality then, as Bos suggests (1988. 392-393), anything new which becomes part of experience, and thus "known", has to be part of what always was. It appears possible that in the past, all new experiences could have been attributed to some new contact with the inside. However, beginning with visits from Indonesian trepangers, then later Japanese pearlers and European Australians, contacts with other previously unknown Aboriginal groups, and now international travel, there has also developed an awareness that the "outside" also contains far more than anyone has previously known. As I will demonstrate in later sections of this and later chapters, there is room for these new realities to be incorporated into the inside reality.

The "inside" explained by means of analogues is taken for granted by all the Yolŋu with whom I have had discussions over the years, though there is wide variation in the perceived nature and contents of that domain. In this chapter, I attempt to discuss some of the range of ideas expressed concerning this inside of reality, its characteristics, and the entities which are considered to exist there. The discussion includes consideration of what is presented by the Yolŋu as if it relates to their knowledge of reality prior to outside contact and observations of some of the changes that have been incorporated since contact with non-Yolŋu people.

MANIFESTATIONS OF THE INSIDE OF REALITY.

A number of different terms are used to refer to discrete traditionally¹ recognised entities that can be experienced, but do not normally have a tangible form. Among these are: *mokuy*, *birrimbirr*, *waŋarr*, and *djamarrkuli*. All of these refer to different beings, although there are occasions when the discriminations made between them blur and the characteristics of the entities overlap. Across the literature these have been variously described in English by a wide lexicon of terms such as spirits, ghosts, trickster spirits, souls, ancestral beings, ancestral spirits, spirit(ual) beings, supernatural powers and totems, and this is not an exhaustive list of English

¹ see footnote 2 in Chapter 1.

translations. In addition to these terms there are other manifestations of the inside of reality which are collectively called *maḍayin* (sacred elements) some of these being referred to by the Yolŋu in English as "totems". In addition to these, and of obviously more recent introduction, the Christian Trinity has been added to perceptions of the revealed inner side of reality, and with this the Holy Spirit has received considerable attention.

My purpose in the section which follows is to give an outline of the Yolŋu concepts of these entities and an introduction to themes which will be examined more fully in later sections of the chapter. Rather than try and describe the different entities one at a time by defining the terms that are used for them in either the Yolŋu or English languages, I will attempt to discuss them in conceptual domains. Thus I consider separately the notions of "totems", ancestral figures, *mokuy*, *djamarrkuḷi*, traces and transformations in the landscape, and the Holy Spirit, all of which in one way or another appear to be treated as manifestations of the unchanging inside of reality. Later in the chapter I will examine in more detail some of the attitudes towards, experiences of and conceptualisations of the latest experiences of the inside of reality which have occurred during and since the 1979 Arnhem Land Revival and its perceived relation to the earlier "Adjustment Movement in Arnhem Land" (Berndt 1962).

While the major *waŋarr* (ancestral figures) are given greater importance, I will discuss the "children", *mokuy*, *birrimbirr* and "totems" first. I begin with them because I want to explore what I consider to be a new approach to the understanding of these entities and it is easier in terms of a sequential discussion to begin with them and proceed to a discussion of the *waŋarr* beings after that.

"Children".

In Chapter 3, I discuss the notion of the pre-birth existence of the individual and the way in which this *yothu* (child-singular) is recognised as coming to

its parents ostensibly to announce its coming and the nature of its identity. These *djamarrkuli* (children-multiple) as I will show are believed to exist before birth, and there appears to be some degree of consensus that prior to taking on a particular "totemic" form to make the announcement of their presence, they exist in an undefined form in the water. This frequently means that they are spoken of as found in the water at the clan's *yirralka* (homeland centre).

Djamarrkuli is also the term used for the familiar spirits that sit on the shoulders of the mediums and whose functions are to communicate information to them and carry out tasks given by them². Thus there is a notion of an indefinite sort of spirit being which in some ways is considered to be a pre-formed or pre-emerged human being and which can communicate with human beings .

Mokuy.

There are two quite distinct uses of the term "*mokuy*". The first of these refers to a dead human, a corpse, or sometimes the continuing aspects of the recently deceased. In the story of Yawuljura (see Chapter 7 and Appendix), a living man who visited an island of the dead, Burralku. The *mokuy*s already there ask if he is a newly dead person, using the word *mokuy* to do so. The narrator uses the same word to refer to those dead who are already on the island, thus applying the term to those who have been dead for a longer time. The second use of the term refers to a group of what can be called spirit beings. In this case, "*mokuy*" is used to refer to a group of similarly perceived entities. There are some anonymous spirits, or spirits which may not have been specifically identified, but there are others which are identified by personal names, by association with particular clans or groups of clans, and particular behaviour patterns. The members of the "known" group are celebrated in dance, song, painting and myth, being generally part of a clan's non-sacred ceremonial stock.

² see also under *Marrngitj* in the next section of this chapter.

However some also appear to be identified with things of high significance to a clan and some to be associated with the ancestral beings.

In the normal way of Yolŋu classificatory terms, number is not included in the noun and when the word "*mokuy*" is used, it refers to a class of beings, sometimes with reference to a single being and at other times to a group³. An indication of the ownership of and characteristics attributed to some *mokuy* of the second type can be gained from Table 2.1.

When one starts discussing *mokuy* with the Yolŋu it becomes apparent that there is no totally unanimous understanding of their nature, their origins or their degree of malevolence, although where they have become celebrated in song and dance there is a degree of common interpretation. Many of them have multiple names just the same as the Yolŋu. For example I was told that the Liya-galawumirri⁴ *mokuy* has his "real" name Warralawarrala, but when he is sung about he has the special song name of Yäjanydja, and that the Wangurri *mokuy* whose "big name" is Djirrapan, has the song names, Guwunun and Mitjpunun when he is male and when female has the names, Liya-wanhurr, Gurrinybal and Rraparrapa.

Warner (1958: 545 - 561) records a series of stories about a *mokuy* named Wurray (his Uré), alias Bamapama, that he describes as;

"the trickster hero of the Murngin. He was a man who lived in the mythological period and committed a great number of asocial acts, most of them incestuous. He is depicted as ever filled with sexual desire and always anxious to satisfy it by attacking the wives of other men, particularly those women who belong to his own moiety."

Each of these named beings has its own characteristics. Some can be aligned with the concept of a trickster as Warner suggests. Others are described as more benign hunters of yams, gatherers of honey, or hunters of kangaroos or wallabies. Those that are named appear inevitably to hunt particular species which are

³ We will see this with the use of the proper name, Mukarr in Chapter 3 in the song of the turtle harpoon rope. There the proper name can refer to either a single being or to a group of them.

⁴ Name of the clan or group "owning" the *mokuy*.

of significance to the clans with which they are associated. One young man in describing *mokuys* and referring to one English concept that has been applied to them, said, "They aren't demons, demons are different, they *buma* (hit, beat, harm, kill) *yolju* (humans)".

Mokuy name	Clan ownership	Particular features
Dhuwa Moiety Mokuys		
Wuluwuma (?= Marritju)	Gälpu and Djapu	Associated with jungle place called Durmuwili where seen at first by a man named Banimi. Linked to <i>ganguri</i> (a yam), <i>maypal</i> (shellfish), <i>wurrkadi</i> (maggot) and <i>guya</i> (fish).
Namurrañaniñ	Ñaymil	Found and stole two women from Wangurri clan
Wuyal	Marrakulu	Linked to <i>dhulaku</i> (rock wallaby)
Warralawarrala (praying mantis)		
Birirriirk	Djambarrpuyñu - Liya-dhalinymirr	Linked to <i>guku</i> (honey) and a variety of stone axe
Mukarr	Djambarrpuyñu	Eats only <i>miyapunu</i> (turtle or dugong)
Wurray	Rirratjuñu, Marrakulu, Marrañu, Wägilak and Djambarrpuyñu	Linked to honey and a variety of yam
Yirritja moiety mokuys		
Burrulupurrulu	Dhalwañu and Gupapuyñu	linked to <i>guku</i> (honey) and a bush place
Ganbulapula (may be alternative name for Burrulupurrulu)	Gumatj	Linked to the bush
Lawirrilawirri (?= Murkanydja)	Gumatj	Linked to a jungle place
Djirpan	Wangurri	May be name for a shooting star

Table 2.1. Affiliations between some Mokuys, clans and their traditionally expected behaviour patterns.

An older man, talking about the characteristics of *mokuy*s said that they don't talk language like people, and they don't wash. They were able to let people know of their presence by hitting trees with an axe or by pushing trees with their hands so that the trees fell down⁵. As to their origin he suggested what appears to be a commonly held view that they were humans at first who had been speared, or got sick and died and become *mokuy*; if they were *bodiny* (calm, quiet, peaceful, non-savage) type of people they would have become *birrimbirr* (see later discussion), but if they were *madakarritj* (dangerous, harmful) then that would explain why they had become *mokuy*.

In summary then, "*mokuy*" can refer to the recently deceased, the long dead, or to any of a series of named beings or unidentified spirits who may or may not be considered to have been human once, the specific meaning being relevant to context. They can, in a number of contexts, be thought of as being somewhat equivalent to the common English use of the word "ghost".

Birrimbirr.

Birrimbirr is the term commonly used to translate the English word "spirit". As a result the Holy Spirit of Christianity becomes *Birrimbirr Dhuyu* (lit. spirit holy or sacred) and Satan is often called *Yätjkurru Birrimbirr* (bad or evil spirit) although this later term is also used to describe an evil spirit of any kind. Morphy (1984:40,41) refers to *birrimbirr* as one of "two souls or perhaps dimensions of soul" the other of which is *mokuy*. He draws the distinction between them saying that,

After a person has died the *mokuy* goes to a part of the clan's territory where *mokuy* spirits live, and exists there as a ghost.

The *Birrimbirr* soul is a complex concept which refers to that aspect of a person's spiritual existence that comes from the ancestral beings On death, the *birrimbirr* soul is believed to return to the clan land of the dead person in order to become reincorporated within the reservoir of Ancestral power associated with that place.

⁵ He added that there were three causes for trees falling; man, wind and *mokuy*.

Although I would not analyse these perceptions as leading to a concept of a "reservoir of Ancestral power" all of Morphy's observations agree with statements that Yolŋu have made to me. Williams (1986:32) also refers to individuals' spirits being characterised by two aspects, though suggests that of these, one is good and the other bad. My own observations would indicate that the situation is more complex and that any dichotomy is less precise than these suggestions would indicate. One statement made consistently by the Yolŋu is that the *birrimbirr* goes to *Burralku* (the place of the dead) after a man dies, but as shown in the preceding section, it is also said that when a man dies that *mokuy* (dead one) goes to *Burralku*. There is no actual conflict in these ideas being used in this way. Nor, as I will show in the next chapter, is there conflict with the statements made in the quote from Morphy where these two are said to go to the clan territory.

The distinctions made between the two are very similar to, though not the same as, the distinctions made between "person" or "personality" and "the deceased" in English. *Birrimbirr* in its general use refers to something more associated with the personality and or spirit of a person in contrast to their structural physical or spiritual form and is perhaps closest to a non-physical transformation of a person's identity.

Totems.

A wide range of mythological narratives has been recorded that are concerned with what is often referred to as "totems". So familiar has this word become to the Yolŋu that they accept and frequently use it as the English translation of their word *madayin*. It is not my intent to become embroiled in the discussion of whether the things so named are "totems", as the definitions of such words are subject to contextual use and to definition. Yolŋu *madayin* definitely do not equate to the common English usage of "totem" which seems to be close to the idea of a team identity symbol. My purpose is not to examine this contrast between Yolŋu and non-Yolŋu use of the word, but rather to consider the understandings Yolŋu have of the things they are talking about, whichever word they use.

In conversation they may use either word as a classificatory term to speak of a set of items which are of ceremonial significance to them, but it is more usual for them to enumerate their items separately by name. At every site there have been such items deposited by one or another Ancestral Being⁶. Thus it can be said of the site named *Gän̄gan*, that the being Barama put there *minhala* the tortoise, *wurran* the diving bird, *birrkuda* the bee's hive, *marki* the freshwater crayfish, and *mundukul* the black headed python. It seems to be more normal to enumerate them this way than to say that Barama put the *madayin* there, although both statements are correct.

It is this mode of naming the *madayin* with the names of natural species that apparently led to the idea that each *madayin*, or totem represents a natural species, and that men therefore have established relationships of some kind with natural species. (For example see Elkin 1938/70:166 and Meggitt 1962/74:59). The names of the natural species are however "outside" names and as Williams (1986:40) says,

Names are also ranked: some are "big", "inside", sacred, and knowledge of them is stringently regulated; others are "little", "outside", names and everybody knows them.

Saying that Barama created or made them or put them at that particular site, and the fact that these natural species are usually common at the site, has led to the idea that these ancestral figures such as Barama or Djaṅ'kawu created the natural species. For example, Morphy (1984:7) refers to "Ancestral beings who created ...". This is not entirely erroneous in the sense that there were items made and deposited at each site. However the items identified as being deposited were not the natural species but a construction made usually from such materials as wood or paperbark decorated with feathers, strings and paint. These constructions, named with the names of the natural species are representations of spirits or spirit beings deposited at the sites. It is primarily with these representations and the spiritual entities that they stand for that the Yolḷu identify, and only secondarily with the natural species which are seen in some way as "outside" transformations of them.

⁶ I use Morphy's term here for the Yolḷu word *wajarr* which is discussed in the next section

Thus at each site there was given to the local clan a set of *madayin* (sacred items, which includes also the associated songs, designs, dances and rituals representative of the "identities" of the inside reality at that site). This set represents the identity of the site, and simultaneously part of the identity of the owning clan, hence also a large part of the identity of the individual members of the clan who own or care for the site.

Waḡarr, The Ancestral Beings.

Most of what I have said about the "totems" can equally be said about the "ancestral beings". The differences between them seem to lie in the fact that firstly the major beings were distributors of others, while what I have described as "totems" are for the most part individual elements that are spoken of as either being deposited by ancestral beings or as moving by themselves or in small groups of two or three, apparently without distributing anything else. Secondly the major beings are explicitly anthropomorphic, and thirdly they link large groups of clans of one moiety.

Amongst the coastal clans the major Dhuwa moiety ancestors are the Djaḡkawu and the Wäwilak (or Wägilak) Sisters, each of which is celebrated in a totally distinct myth/ritual complex. The major Yirritja ancestors, all of whom are celebrated in the one myth, are Barama, Lanytjun, Galparrimun and Banatja⁷. In each of the myths these beings appear to have the characteristics of humans combined with those of supernatural beings, and it appears to be this combination of attributes which has been responsible for the wide diversity in attempts to classify them in English.

Each of these three myths purports to be a historical record of the journey of a set of ancestral figures across the coastal sections of North East Arnhem Land country. These travels form the basis for the current structure and contents of the religious activities of the Yolḡu people, the figures being commonly referred to as

⁷ In referring to there being three sets of major *waḡarr*, my focus is on statements made by members of Yolḡu groups represented at Elcho Island and Yirrkala, and may not reflect the number relevant to other parts of Arnhem Land.

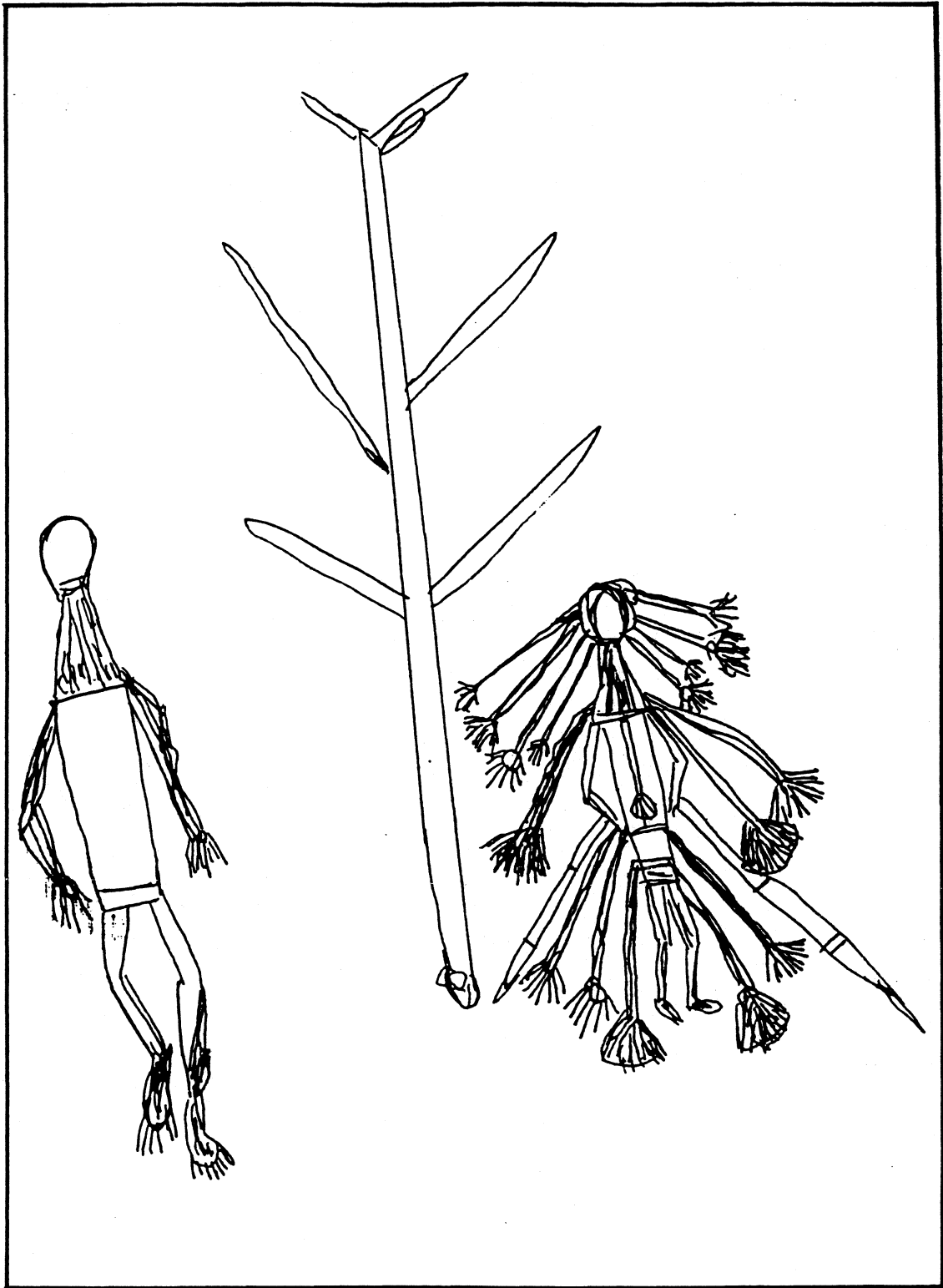

Figure 2.1. Djan'kawu woman prior to loss of *madayin* (secret/sacred) items to men (Drawing by Djorrrpum).

wagarr. No two Yolŋu people recount these myths in the same way, though there are common themes which run through all versions. What follows therefore is my own brief summary of each of them based on discussions with the older men from Elcho and Yirrkala and with reference to the major works in the literature. [These include especially the works of Berndt R (1951 and 1952), Warner (1937/58) and Groger-Wurm (1973)].

The Djaŋ'kawu myth.

The Djaŋ'kawu according to most versions came from an island somewhere to the East of Arnhem Land which is usually called Burralku. They travel by canoe, paddling all the way, and bring with them in the canoe a quantity of *ranga* (sacred objects) carried in *ŋanmarra* (large conical mats), together with their *bathi* (sacred dilly bags) and digging sticks for which there is a wide range of names. The term Djaŋ'kawu is a collective term for a group of individuals which among the clans east of Elcho Island is generally described as a brother and two sisters. Among these clans Djaŋ'kawu is also the personal name of the brother. Further west the clans speak only of the two sisters.

The men from Elcho and to the east seem to be in some agreement that the Djaŋ'kawu came first to Rirratjinu country, landing at Yalanbara near Port Bradshaw, then from there travelled across the country from the site belonging to one Dhuwa clan to the next, avoiding for the most part contact with anything including country which belongs to the Yirritja Moiety⁸. As they travel, either by foot or canoe, they carry with them the *ŋanmarra* full of *ranga*, their dilly bags and digging sticks. (See Figure 2.1.). At each place to which they come in their travels there is a fairly standard pattern of activities that, in the non-restricted versions of the stories appear to include the establishment of waterholes by the plunging of their digging sticks into the

⁸ The order in which the clans and their different locations are visited varies from informant to informant. Apart from the general details, each man's narration is one that emphasises his own clan's priorities.

ground, the identification or depositing of particular species as sacred objects for that location, the singing of songs relevant to that location and often a depositing of children. At some locations when the digging sticks are plunged into the ground these are spoken of also as growing into trees.

At each location something of significance occurs which makes the activities at that site unique and hence serves to identify the site itself as a unique location. For example, following Groger-Wurm's (1973: 23, 24) descriptions, in Marrakulu country at Trial Bay they made the goanna, djalka [*djarrka*] a dreaming for the Marrakulu, in Gälpu country they made a sacred waterhole and placed *rannga* (sacred objects) in it. In Djapu country between Caledon and Trial Bays, they made waterholes, and at that place they also saw goannas, brolgas and pelicans and made them "dreamings".

During their travels there comes a time when the sisters hang up their baskets on a tree and then go to collect shellfish. While they are absent the baskets are stolen by men who in so doing establish the ongoing justification for men's dominance in ritual and the women's roles as gatherers of food and bearers of children. I have been shown the site where this theft occurred on two separate occasions at places a hundred kilometres apart. Keen (1978) and others record still other sites where the event occurred. In every case the site shown is adamantly claimed to be *the* place where the sacred items were stolen.

The Wäwilak Myth.

In this myth two sisters from the Wäwilak clan from south central Arnhem Land become pregnant to men of their own clan, leave their country and travel north. As they travel they carry out the normal activities of food gathering common to Yolŋu women and each evening camp for the night, cook their food and then continue their journey to the north, with one of them giving birth to a child as they travel. Eventually they camp at a waterhole named Mirarrmina (and various other

names), which, unknown to them is the home of a great python. Inadvertently one of them pollutes the water with blood⁹ and this disturbs the python. In some versions also the second sister gives birth at Mirarrmina.

They start to cook the vegetables and animals they have gathered that day but these run out of the fire and into the waterhole. At this point they realise that they are witnessing something unusual. A cloud caused by the python appears over them and rain begins to fall on them only. The sisters construct a bark hut for shelter, then they dance to stop the rain without success. The python comes towards them and they try to hide in the hut. He¹⁰ swallows all the humans and retreats to the water where he feels sick (because the two sisters are Dhuwa moiety the same as he is) and vomits them up. Ants bite them and they come alive again. The snake reswallows them gaining another severe stomach ache. He stands up to the sky and crashes to the ground, leaving a triangular mark on the ground¹¹. After being forced to confess his crime to other serpents, he flies away and in some versions of the story creates a variety of places, species, waterholes and eventually men. Kupka (1965: 112) records that the sisters later appeared to men in dreams teaching them the story and the ceremonial details associated with the events.

Barama, Lany'tjun, Galparrimun.

I first recorded the myth that links these names in 1967 in association with a series of paintings by men of the Dhalwaṅu Gumana clan. In outline their version of the story tells that Barama came out of the sea and arrived at Gāngan in Dhalwaṅu country where he taught sacred designs for the Yirritja clans to two men, Lany'tjun who travelled to the north, and Galparrimun who travelled to the south. These men distributed sacred items to all the Yirritja clans, however one group became jealous of

⁹ Berndt (1951.20) records this as the elder sister's afterbirth blood, while Warner (1958. 252) records it as her menstrual blood.

¹⁰ Berndt (1951.21) recorded the python as female.

¹¹This shape is now used as a model for the ceremonial ground during ceremonies

Lany'tjun because he had too many sacred things, and they killed him¹². He fell on an ant's nest and their bites stung him back to life whereupon he returned to his original country and became a large paperbark tree beside the waterhole there.

Linked to this myth is a wide range of stories which focus on the distribution to individual sites and clans, of different versions of the diamond patterns used by the Yirritja clans in their paintings, with diamonds being interpreted as fire, water or honey by different clans according to the associations of the events in their country.

Those then are very basic summaries of the three major myths. Even at this level it is reasonably straightforward to isolate features that identify each set of ancestors as discrete.

Traces.

Wherever the Ancestral beings travelled, they left traces of their passing in the landscape, and these traces are seen to be the transformation of some part of or some body product of the ancestor, or the results of its action at a place. For example, it seems that almost inevitably the red, yellow, white and black pigment deposits across Arnhem Land are transformations of some part of an ancestral being. These include such things as turtle fat or the fat of other animals, dugong faeces, honey and pollen (see Rudder 1983:103).

Transformations may be entire geographic features or a single rock on a long beach, a tree, an impression in the surface of a rock or a combination of any or all of these¹³. An example of this is the shark site at the southern end of the Martjanba Island where the prominent headland is the shark's head (See Map 2.1 and Figure 2.2)

¹²Other versions have it that they killed him because he was singing sacred songs out in the open as he travelled along.

¹³ Munn's (1970:142) suggestion that there are three types of transformation; metamorphosis, imprinting and externalisation is supported by the Arnhem Land material described here.

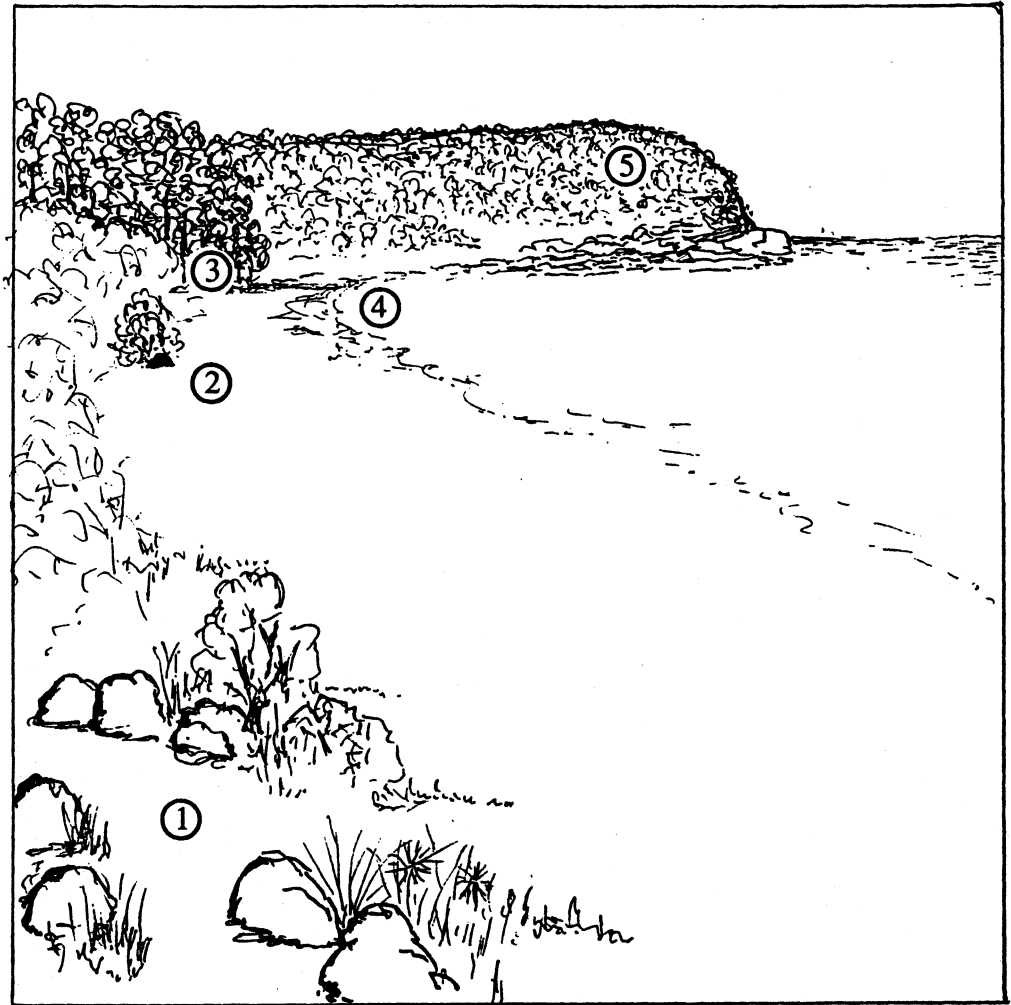

- Key.
1. Rocks are shark's bones (naraka) at Wäyingurra.
 2. Single rock is shark's brain (nurrku) on beach named Mulaljurra.
 3. Creek (mayan) and billabong (gulun) are alimentary canal at Guljurunupa Creek.
 4. Mouth of creek (dhurrwara) is shark's mouth.
 5. Headland is shark's head (buku) at Barupu.
- Liver site is above and behind the artist at Wakaya. (See Plate 2.1 and Map 2.1).

Figure 2.2. Shark site on Martjanba Island.

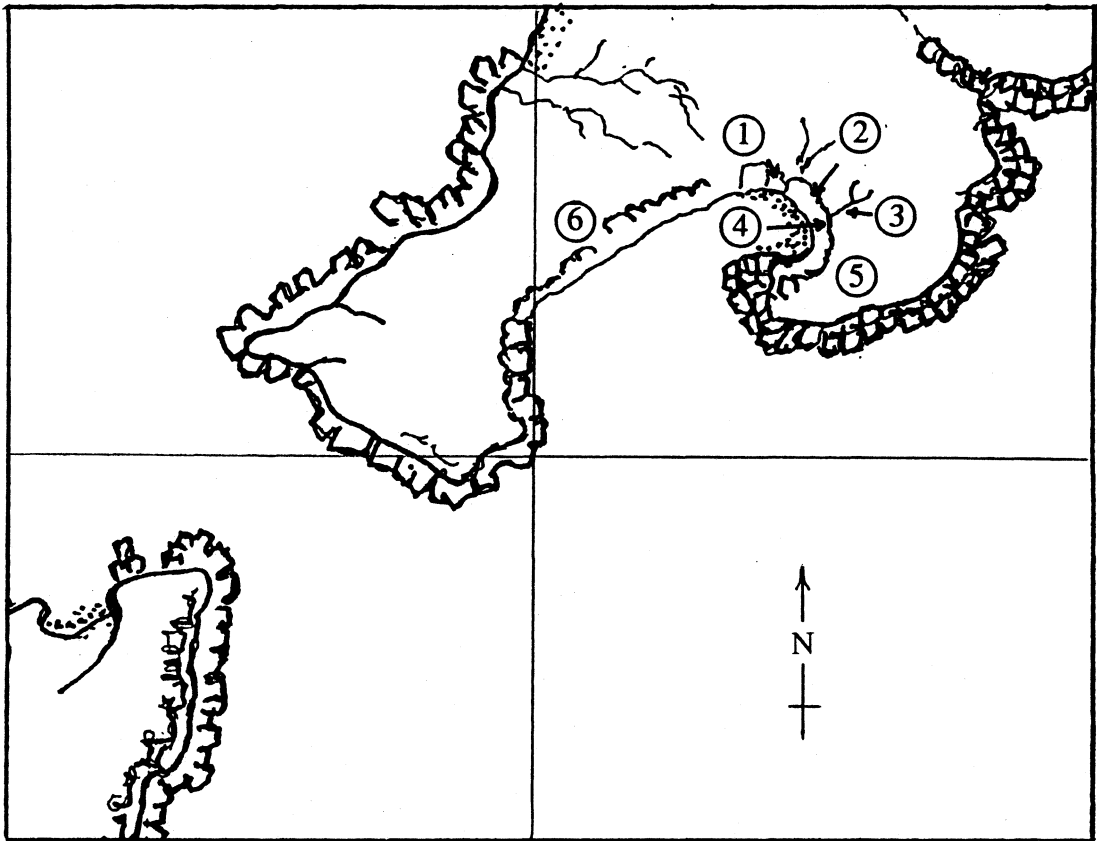

- Key.
1. Rocks are shark's bones (naraka) at Wäyingurra.
 2. Single rock is shark's brain (nurrku) on beach named Mulalḡura.
 3. Creek (mayan) and billabong (gulun) are alimentary canal at Gulḡurunupa Creek.
 4. Mouth of creek (dhurrwara) is shark's mouth.
 5. Headland is shark's head (buku) at Baruḡu.
 6. Liver site is at the top of the cliff at Wakaya. (See Plate 2.1).

Map 2.1. Shark Site on Martjanba Island.



Plate 2.1. Shark's liver site on Martjanba Island displayed by Dhapa.



Plate 2.2. Shark's brain site on Martjanba Island displayed by Djingulu.

A billabong and stream flowing from it to the sea are the shark's stomach and alimentary canal and the mouth of the stream is the shark's mouth. On the beach a small rock is the shark's brain (Plate 2.2.) and a double depression in the rock surface on a cliff top adjacent to the beach is a transform of the shark's liver. (Plate 2.1.).

At sites where the major mythological figures are said to have "gone inside" there is likely to be a whole series of such traces as mentioned above or as discussed in Chapter 5 concerning the southern end of Elcho Island¹⁴. At the location where the Djaŋ'kawu went inside, there is one rock in particular that is considered to be a transformation of one of the Djaŋ'kawu women. (See Plates 5.1. to 5.3).

There is not a high degree of discrimination used in naming the various spiritual entities responsible for the traces in the landscape. For example in listing and describing a number of sites one of the elderly men said of the place named Bun'tayal that a

<i>Waŋarr,</i> ancestral being	<i>mokuy ,</i> dead one	<i>dhulyurruna</i> built	<i>marthajay ,</i> a boat	<i>balanda,</i> white man
<i>bala</i> (then	<i>ŋayi warryurruna</i> he dragged it	<i>mayanŋurr</i> through the creek/watercourse.		

This roughly approximates in English to saying that there was an ancestral being who was or is a deceased person, who was a white man, made a boat and dragged it through the creek at that place. This sentence makes perfect sense although the ideas appear complex. I include it here simply to indicate how the meanings of the terms overlap or at least appear to do so. They are certainly not used in a clear cut and consistent way all the time. On other occasions Yolŋu have attempted to clearly distinguish between *waŋarr* and *mokuy* and it would not be normal to describe a *balanda* (white man) as a *waŋarr* (ancestral being). I take up the discussion of these "spiritual entities" in later discussion of the afterlife in Chapter 3.

¹⁴ Morphy, Keen, Berndt and others record such series of traces.

The Holy Spirit.

In 1979, there began on Elcho Island what has since become known as the Arnhem Land Revival, an indigenous Christian movement that began at Galiwinku early in 1979. Almost every Yolŋu adult was involved to some extent at least initially. While the obvious involvement of individuals has shrunk in terms of numbers, the majority of the community now consider themselves to be Christians. In 1981 I had the opportunity to discuss with Djorripum, one of the senior ceremonial leaders his own early experience of it. His first sentence was a very concise summary of a more general Yolŋu response,

We heard that the Holy Spirit was born at the top of the hill [the church], so we went up to meet him.

That is to say that the knowledge of the Holy Spirit came by experience. The missionaries had brought many stories, and there had over the years been a number of Yolŋu individuals who had had experiences of one kind or another with the Christians' God, but until 1979 this had remained a matter for individuals. Now almost the whole community was swept up into a corporate experience of "coming under a conviction of the presence of God" in the form that they recognised as the Holy Spirit.

As I have considered this very much Yolŋu movement, it appears to exactly match Yolŋu understandings of life and of the relationship between the "inside" and the "outside". The fact that the Holy Spirit has come "outside" has produced an ongoing awareness of a new freedom to meet with God, and to come into contact with the "inside" reality in a controlled but less restricted way. The annual "Revival Thanksgiving Weekend" has developed as an important ceremonial event on the annual calendar, and I discuss this later in the chapter in relation to "The Two Revivals"

TAPPING POWER.

There is widespread if not universal belief that in addition to the above mentioned manifestations of the inner side of reality, there is available some kind of undefined power which can be used in various ways for both good and evil purposes. There are various terms used to refer to such activities and to the persons who carry them out. Though there is a fairly wide variation in the way the terms are used, there does appear to be some agreement and I have attempted in the following section to consider a selection of both generally accepted ideas and alternatives.

Marrngitj .

The word *marrngitj* is a term applied to a person who relies upon familiar spirits and divination for direction, who is thought of as working for the good of other people, and who, in addition is likely to be someone with a highly developed knowledge of practical medical treatments. As one man said,

Marrngitj has *djamarrkuli'*, (literally = children) sometimes call them *warrakan* (animal), on shoulder, can be Dhuwa or Yirritja. The name *marrngitj* is given to the person by the *djamarrkuli'* who talk to him/her and say, 'Come on we'll make you *marrngitj*'.

The same man said that,

Alatha'alatha are children on Yirritja shoulder, something like Timor or Macassar magic.

The *marrngitj* is said to listen to the *djamarrkuli'*, on his or her shoulder and then he knows what to do. The *djamarrkuli'* can make a *gara* (spear) come out from inside a person. They can also bring information to the *marrngitj* concerning other people, their actions and even their conversations when the *marrngitj* is at a different location, in a way almost identical with that described for the spirit familiars of a European medium.

The reputation of the *marrngitj* who is effective spreads far and wide especially when there are known cures of serious problems. For instance I was told that,

W..'s older sister (a female *marrngitj*) was living with B.. and that. M.. went to her when he was real sick and she made him better. You pay \$20 a visit. Now she's gone to live at G.. . The *balanda* (white) doctors at Gove know her. G.. at Milingimbi was hit by *nyera* (sorcery) by Alice Springs yolŋu and he went *baba'yun* (mad) - she fixed him too.¹⁵

Webb (1936) recorded that *marrngitj* was the name of the spirit familiars and quoted two stories of men who became *marrngitj* by establishing relationships with spirit familiars. Thomson, who made his observations in the late 1930s and early 1940s recorded (1961:97) that the medicine man was named to him as *marrngitjmirri* (lit. *marrngitj*-having). As he said,

According to most of my informants, the cult of *marrngitjmirri* or medicineman in eastern Arnhem Land is restricted to men only, and is not secret - that is, it does not depend on ritual or supernatural backing, and is carried out in open camp without any secrecy, in the presence of women and children.

Whether there has been a change to allow women to become involved, or whether such claims from the men are still their ideal it is not possible for me to assess. Thomson also makes the note that *marrngitjmirri* were authentically from North East Arnhem Land and that the *galka* (also called *ragalk* see below)"do not occur among the same people" (p98) a statement he had made in disagreement with Webb who had claimed that they did. Whatever the situation was in the 1940s, there is no doubt that both types of practice are currently, and have been being used across the whole of Yolŋu territory since at least as early as the 1960s.

¹⁵ Janice Reid (1983:64), apparently referring to the same woman, says that her "skills are such that she is visited by by patients from Milingimbi, Elcho Island and Yirrkala " Reid also refers (p65) to concern expressed by one man over "rumours that the medical authorities were attempting to persuade her to go and work at Darwin at Nhulunbuy Hospitals", and that the "doctors there might be jealous of her powers and try to kill her".

Galka

According to Reid (1983: 84),

Galka are a special type of sorcerer. They are specialists who have learned their trade and have privileged access to the realm of the dead and its powers."

She suggests that while anyone could practice a wide range of sorcery type activities, accusations of sorcery were only covertly made. In contrast to this (p88) the

galka can provide a convenient scapegoat when an internal killing threatens group solidarity: he is sometimes said to arrange his victim's death by suggesting, while the victim is in his thrall, that he go home and provoke a fight with a kinsman. In this fight the kinsman is killed.

One informant said that the form of sorcery carried out by a *galka* is called *ragalk*. Its specific intent is the death of the individual chosen as victim, and *ragalk* may be the suspected cause if a person is killed by a crocodile or a rifle bullet.

In contrast to these more popular associations with the term, one very senior man told me very quietly that a *galka* was really a man chosen to carry out a stealthy revenge killing. He said that there were always senior and experienced men moving about on religious business and it was no-one's business to inquire as to their activities, so it was easy for one of these men to be chosen for the task. He would simply go away on religious business, carry out a stealthy killing, give time for the excitement to cool down and then one day simply return from his religious journey, anything up to three or four months after the death, and be very surprised about the news when it was relayed to him.

***Nyera* .**

Nyera appears to be a general term for a wide range of activities that can be considered as different forms of magic or sorcery. It is used to cover such practices as attracting another's love, attracting rain, for hunting magic, to kill a person, to cause

sickness or madness, or to weaken an enemy before fighting. It can involve singing, particular actions, and the use of objects and substances any of these being considered effective alone but there is the indication that their combination is thought to increase their effectiveness. So *nyera* appears to be a word with a wider scope in meaning than *ragalk* mentioned above.

A number of different activities were described to me that were practiced with the intention of winning the love of a member of the opposite sex. Only the first of the three recorded here was actually named as being *nyera*, the others were simply described. In this first practice a man sings for a woman and puts her name in the song. It was said that this

goes through the woman's heart like wind, and then she wants that man.

Sometimes a man will sing this type of song with friends. It was also said that a woman can make a *nyera* song for a man. The second practice involved a man making a fire in the bush.

When his smoke goes right up straight, his spirit goes up in the smoke and a woman sees it and goes straight to it.

The third love magic practice appeared to be more concerned with establishing a permanent relationship than with a short liaison. To use this,

a man digs a hole and washes his clothes into the hole and sings for a woman to marry him, and then puts the clothes on. Then the woman will come straight to him and then they will get properly married.

Substances Used in Tapping Power.

Various substances are thought of as having considerable effect in sorcery as has already been indicated by some of the above descriptions. One, considered to be very powerful is *betjju* or *wola*. This is dried heart blood from a person or an animal which can be used for hunting or for killing by sorcery. As it was described,

a *galka* or a man collects heart blood. To use for hunting for turtles or fish he throws a little bit on the water. For hunting in the bush you heat a little in fire and rub it across the body. Then only one shot and not miss. Or you can rub it on a spear and it will go straight.

For killing a man the efficacy of *wola* can be combined with a sting ray spine. To use this,

you tie up your arm and then put *wola* first and then the spine on your hand and point it at a man. Then a *mokuy* will push the spine into that person likelighting.

According to this practice it is also possible to gain through *nyera* either the active participation of spirits, or the control of power of some kind, though I was not able to clarify which of these was thought to occur. Other substances were also used and it was said that,

Djiritjirri is different. It is something that you put in tea to make yourself attractive to women. It is a sort of *munatha* (earth or soil) from Roper or Rose River country (Just outside of Yolŋu territory) and is magic.

Another *miyalkpuy girri* (woman-concerned with substance) is like a stone. You scratch some off and put it in a womans tea.

From the above descriptions it can be seen that the range of ideas concerning available "power" and ways of tapping and using it are quite wide. There is a range of practices where there appears to be simply an undefined power at work. In some there may be the use of substances which are thought to have magical efficacy if used in an appropriate context. In others there is understood to be an attribution of positive or negative function to these practices according to whether their actions are helpful or destructive. For example, *djamarrkuli* were described as removing a sharp object from a person, so therefore could be thought of as helpful, and as carrying out a positive function. *Mokuy*, in contrast to this, were described as available to pierce a person with a sorcery object, and thus carry out a destructive and hence a negative function. Neither the negative nor positive functions can be equated absolutely with Yolŋu notions of good or evil as such practices are relative to the persons carrying them out and those on the receiving end, though there is a generally expressed dislike of the negative, which appears to have become much more openly expressed since the Revival.

Ancestral Power.

In addition to the above ideas of power that is available for use, there is thought to be what Morphy (1984:19-20) describes as "the spiritual power of the Ancestral beings" which he says is,

thought to affect individual's lives and contribute to their well being. As a person grows older and participates in more and more ceremonies he or she establishes a continuing relationship with the clan's Ancestral beings. In ceremonial contexts the power of the Ancestral beings, which is objectified in the sacred objects and paintings, can be transferred to participants through having their designs painted on their bodies and having the power words of the songs sung over them. Thus, as they grow older, people accumulate spiritual power.

Such ancestral power is thought to reside in the traces left by the ancestors and hence, when these are in the form of pigment deposits, also to reside in the pictures painted with them. (cf. Morphy 1984:73). I have on occasion been shown small pieces of such pigments by men who handle them with what could be described as reverence worthy of something of extreme value.

There seems to be a very real contrast between this kind of power and that generalised sort of power that is tapped in the above described sorcery type practices. The power of the ancestral beings, to continue using Morphy's term, seems to be associated more with a group's identity, their sites, and their eternal existence. It would appear to be something of this nature that is considered as being handled when they are handling the *ranga* (sacred objects), the traces, or even naming their "inside" names, so that in handling them it could be interpreted that they are handling not simply a respected power, but their own personal reality, their "identity" in a tangible form. It is not surprising then the degree of reverence which some men express towards the slightest expression of it.

It appears also that there may be some consideration that this form of power is able to be tapped by the *dalkarramirri* (Yirritja religious specialist) through the songs that they sing, as exemplified in the following description from *Djangirrawuy*, which I will include without further comment here,

When I'm sitting with a man and he's dying, the first thing I do, (when he's losing wind and suffering), is sing *wata* (wind), *burrmalala* (cyclone). With that song I'm trying to bring that wind, breath back to him.

If he loses and passes away and lies back on his elbow (*likan nayi li djipthun*) like broken branch, sing *mayku* (*barrukala dharpa* [paperbark tree]). Instead of saying, "He's gone", I sing the song that says, "He's resting in peace", and in that song mention the places and announce with my spirit where his spirit has gone. My mind and feelings are *madayinjur* (with the sacred things).

Next I sing "*guku*", (my spirit turning into *guku* (honeybee) and flying). The song tells where he's started and then his journey as *guku*.

Then sing *mokuy* ([spirit being named] Murayana). Same thing. He looks for sugar bag and goes on journey. (like spirit of the deceased looking for hive). Murayana combines to *guku* (honey) and *wata* (wind). *Nayi li wandirri, mokuy* (He runs about, the dead one) and wind *galpa buma* (blowing on his skin) and *dhupuma* (walk along looking upwards) for sugar bag.

After *mokuy*, singing about "*marr*"¹⁶ (a man's deepest desires and feelings, likened to string), but singing about the string called *Yaliyalı* and *Rätja*. That string from Djarrakpi links to Martjanba and *bejur* (from there to) Cape Shield. The words of the song are:

Märrdja narra weyinjumirriy, nhakuna Rätja budutthun, (my innermost desires belong stretched out long like the string Rätja)

Yaliyalı (Mangalili), Gulunguma (Mangalili), (string names for Mangalili clan)

Marrtji (It goes) Njuruwalma, Gandañuwala, Gurilkawala, (names of channel between Elcho and Matjaka)

Wiripunydjja (Other ones) Rrimbitja, Garrtjułula, Dhamburrthamburr, Malañarri, (Wessel islands places)

Gamalwala, Wułañaniwala. (Cape Shield places).

Special names for the places linked to the dead person, like the long string *Yaliyalı* that links these places. It is a *Guwak* (bird species) that links his *yäku*. (name) *Marrju* (possum) also climbs through that rope. By singing the song, its like praying how much we love that *mokuy* (dead person). Our love is long like the long string. It doesn't help the *mokuy* (dead person), it helps our beliefs.

We perform in a special way, making *bungul* (ceremony) and *manikay* (song) so we feel comfort instead of hard feelings or jealousy. He or she is dead and already *madayin* (sacred), and the body is respected like a *madayin* (sacred) object.

Church is a different story, but if in the house, can't move the body without ceremony. It's like the body being there turns that place into a *ñarra* (sacred shelter) place.

The first five songs to start are *burrmalala* (cyclone), *dharpa/mayku* (paperbark tree), *guku* (*birrkuda* [bee species]), *mokuy* (dead person) and *Rätja* (particular ritual string). *Dharpa/mayku* and *guku/birrkuda* tells the dead person that he's already *objectthirra* (Ceased to be a human and become a sacred object). Those songs also indicates and tells people that person is dead. I'm sitting close to him and I'm the only one who knows yet. I get the clapsticks and sing those five songs.

These five songs also form like a map section for the *mokuy* (dead person) to follow, which and where we announce his journey to special place.

¹⁶ *Märr* interpreted by Thomson (1975) and others apparently following him as power would often be better described as having power rather than as being power. The notion that it is "power" restricts its domain of meaning and produces a miss-emphasis. It is frequently referred to by the analogue of string or rope (*raki*) as is done in this quote and in Thomson (1975:8) The analogue is expanded more fully in the following chapter. It was described to me as emotions and feelings that connect a man with, among other things, his sacred things.

For us that song "Djärr", (*dhupuma ñayi dhu mokuy* [walking along looking upward he will, the dead one]), he's looking at honey hole. (For me that honey hole is *djiwarr* [heaven]). It's called *Djärr*. (I come from Burrumjurr).

This quote gives clear indication of the belief in power available in association with the act of singing. This power is not defined but linked to the inner side of reality in the sacred dimension, and controlled in part by the use of and manipulation of analogical reference.

RELATIONS WITH THE INSIDE OF REALITY THROUGH THE RELIGIOUS SYSTEM

Having looked briefly at some of the perceived ways of tapping power, I now turn to a consideration of some aspects of relationships with the inner side of reality. In looking at the ways Yolŋu do this through the religious system, I have chosen to restrict discussion in several ways. In particular, the different vehicles for religious knowledge, by means of which the inside of reality is experienced are skimmed with extreme brevity before concentrating the rest of the section onto one form, the narration of myth. I examine some of the ways in which myth is used as an example of the ways in which all the forms are potentially able to be used. These include the ways in which information about the inside reality is restricted or released, the ways the religious system functions, and the ways in which control of the society is maintained in the hands of a few senior religious specialists.

Vehicles of Religious Knowledge.

The Yolŋu experience of the eternal cosmos is represented in a variety of forms. These include narrative or myth, song-poetry, dance and two and three dimensional representations such as painting and sculpture¹⁷. Each of these forms represents a different vehicle of religious knowledge. In Yolŋu thought knowledge of

¹⁷It would also be true to say that as all named things in the outside world are are transformations of elements of the inside of reality, then the whole cosmos and every discrete element of it becomes an unbounded vehicle of religious knowledge.

any of these forms equates to religious experience associated with them, for knowledge of anything means to have experienced that thing, and knowledge of the inside reality means to have experienced that inner side of reality. The various vehicles of religious knowledge are then the means of passing on the corporate experiences of the society, and in one way or another, a means of entering into those corporate experiences.

Concerning dance, Williams (1986:44) makes the point that dancing is much more than a re-enactment. She says that,

During their performance dancers are demonstrating their identification with the spirits important to their group, and with each performance they acquire more of their essence, become more like them.

On the assumption that she is correct, dance, for the Yolŋu, becomes an experiential mode of learning to know, and a vehicle which brings them into closer relation with the inside reality of their own eternal "inside" identity.

The paintings of two dimensional representations, whether on the human body, on bark, or on the surface of other representations, is an experiential contact. In the actual process of painting there is a contact with the ochres (which are traces of the ancestral being) and hence a handling of one transformation of the actual being. Of more significance however is the sense that the production of a painting (or the act of being painted) is a coming into contact with (or of actually becoming, in the latter case) a new transformation of the entity being painted. As it becomes manifest in a new "outside" expression of the "inside" reality, the men involved are actually expressing their own power, the power of their own "identity" as they produce this transformation. When painting or three dimensional objects are being produced in an "inside" ceremonial context then, the experiential awareness of the "knowing of the entity", the invisible *raŋga* (sacred items) and of the reality of their own "identity" is heightened to an extreme level, the most intense of the religious experiences. One Yolŋu leader attempting to explain some of the significance of this experience said,

You can't see the *rannga*, but the objects show and reveal. The *naraka* (core) of wood refers to the actual original object, and to the mystery handed on by the ancestral spirit.

As far as songs are concerned, I have had an older man complain to me that the young men, instead of coming to know them properly through learning them in a ceremonial context, and by listening to them on a succession of ceremonial occasions, are learning them from tape recordings, so don't know them properly. It appeared to me that in this there could have been either a contrast being made between knowing experientially in the proper context, which was real knowing, and gaining head knowledge, which was not real knowing, or alternatively a contrast between simply knowing words and tune and knowing of "proper style"¹⁸.

In these ways the vehicles of religious knowledge are expected to communicate that knowledge experientially and they are considered to do this most effectively only when this occurs in the correct religious context.

Myth as a vehicle for recording the establishment and maintenance of relations between groups.

A further aspect of the *maḍayin* (sacred) items, particularly those analogous to natural species is that in the myths they are frequently said to make journeys themselves. For example there is a story about a dog named Djuranydjura that comes from Gupapuyṅu country called Djiliwirri, visits several sites on the way but is following the smell of whale that was coming from Nanjinburra at the far Northern end of Elcho Island. When he reached that point, he tasted whale and immediately started to talk Warramiri language (when he had previously spoken Gupapuyṅu).

I have chosen this story firstly because it is very short, but secondly because it was told to me in a specific teaching session from one of the men as an

¹⁸ there is also perhaps the implication that then the control of such knowledge was being retained in the hands of those whose right it was to control it.

example to help me understand stories in general. Djuranydjura, in this story, is a dog. It can in fact be described as the name of an "ancestral dog" which has belonged to the Gupapuyŋu clan for a long time.

In the story as it was explained, the name Djuranydjura is not referring simply to a dog that makes a journey but to a ceremonial item of that name which is a major element of the Gupapuyŋu clan's identity, and to one or more representatives of the clan itself. The story, according to my Yolŋu tutor, tells that at some time in the past, a man or men of the Gupapuyŋu clan saw that there was an advantage to be had by establishing a relationship with the Warramiri clan who have "whale" as one of their major ceremonial items. That is they "caught the smell of whale and followed the scent". They travel to Nanjinburra where they "taste" whale. That is they establish a relationship with one branch of the Warramiri. This relationship is in some way associated with each group sharing details of their sacred items so that each knows the other through experiencing (tasting) the presence of the spiritual entity involved and the "dog" (Gupapuyŋu clan) and the "whale" (Warramiri clan) are exposed to each other. Now as a result, the particular section of Warramiri clan that was involved has a dog *ranga*. It is however not named Djuranydjura, but Burungitj and Gurrumiya.

There is the implication with the exchange of these items that there is also an exchange of the spiritual entities that each group controls, with those spiritual entities being affiliated with the locations represented by those groups.¹⁹

It can be seen from this that what appears to be the story of the journey of a "totemic" animal, dog, from one place to another is a record of the establishment of a complex set of relations between clans through the exchange of spiritual entities told in analogical terms and which may also involve the migration of a section of the Gupapuyŋu people. The implications of the way and the context in which I was told

¹⁹ There is also the possible record in this story, carried in the suggestion of "eating" a euphemism for copulation, that in this establishment of relationships, arrangements were made for one group, (presumably the Warramiri) to give their daughter's daughters to the other as mothers for their children.

this story is that the majority if not all such narratives of the travels of *maḍayin* (sacred objects or identities) from one place to another are similarly oral histories of the establishments of such relationships told in the guise of the travels of natural species in "ancient times".

If this type of interpretation is applied more broadly it would be possible to interpret the major myths of the travels of Djaṅ'kawu and of Barama as both the history of the step by step movement of a religious cult with its set of objects including myths, songs and dances across the country and the establishment or affirmation of a set of interclan relationships by the sharing of a single aspect of the "inside identity". The Wäwilak myth is quite different as regards the step by step movement, but can be similarly interpreted as an exchange of and establishment of relationships. In their case this is concerned with a relationship between the Wäwilak people and those further north.

The Arnhem Land political scene is one of constant flux in the development of and breakdown in relationships and the constant speaking out of such narratives is one way of calling on the past in order to influence the present.²⁰ There is potential within the religious structure for the continuous extension of the "journeys" of these beings as they appear to function as tools or documents of established relationships. Williams (1986.38-39) refers to one technique for the extension of such relationships by the "discovery" that a certain item already exists in another group's territory. Such a new revelation can then be used as basis for recognising that the journey of the spirit-being has incorporated that territory and the myth will be extended to incorporate it also. Such justifications are easily considered to be something that the ancestors knew but which had been forgotten and rediscovered.

²⁰ Actual examples of the use of one myth in this way are given in Chapter 7.

It is just as easy to work the "discovery" out the other way round as I have described in the story of Djuranydjura and start with an exchange of sacred items, their associated songs and meanings. Whichever basis is used, myth automatically becomes a vehicle for the recording of such exchanges and of the consequent relationships involved.

Analogue as a vehicle for the control of Religious Knowledge.

Myth can be communicated through any of the different vehicles of religious knowledge, but here I am considering only the narrative form. As I have just demonstrated without actually discussing this particular aspect of Yolŋu mythology, a myth has the superficial appearance of being a straightforward narrative, but carries with it a number of esoteric references which are communicated to those who have previously been given keys to open the particular levels of reference.

It is never possible to be certain that one has acquired the innermost levels of meaning, nor even the keys to them, and there is an understanding intimated by many informants that these levels of meaning are known only by the few very senior ceremonial leaders. The Myth of the Turtle Harpoon Rope discussed in Chapter 3 is shown to have a number of different interpretations. While three separate analogues of the story were available, I am led to believe that there are further levels of analogue, but these were not revealed to me, and I do not know whether there is only one further level or more than this. All that can be said of that at present is the standard Yolŋu answer in the situation, that, *Nalapal marggi*. (The old people know)²¹.

The Djaŋ'kawu story recorded earlier in this chapter is probably never narrated in total and there are outside and inside versions which only vary from each other in terms of details of the contents. Closely linked to the myth are the song cycles of which each clan has its own version. One collection of 188 of verses of the more

²¹ This expression is ambiguous and can refer to either living or deceased "old people".

eastern clans' versions of these songs were published in an English translation by Berndt (1952). In the north east of the Yolŋu territory the general outline of the myth appears to remain basically the same irrespective of version, and all versions appear to have the similar ranges of analogically carried meanings. Variation in content appears to be related to the context of narration and more specific details may be included or even excluded to match the intent of the narrator in terms of meanings being communicated.

Apart from the valid meanings of the surface level of the narrative, there are other sets of meanings carried within the myth by means of a combination of analogue and the relationships between the elements of the story. Each level of interpretation is then able to be understood only as the meanings of the key elements for that level are revealed. Berndt (1952) describes the meanings of some of the key elements at one level which enable the myth to be interpreted as a presentation of human sexuality and fertility filled with poetic descriptions of copulation, pregnancy and childbirth. On the basis of the interpretation of this level of meaning Berndt claims that this is a myth fundamentally concerned with fertility, both of humans and of nature, with an emphasis on the maintenance of the fertility of the natural world.

His interpretation of this analogue is true to Yolŋu interpretations, but whether his analysis of this myth as being a presentation of the Yolŋu role in the maintenance of the earth's fertility is a valid proposition or not, I have no answer, except that I have never heard the Yolŋu refer to such maintenance even by allusion. Berndt however claims (ibid.12) that both the Djaŋ'kawu and Wäwilak are "concerned with sexual functions and with peculiarly female characteristics" and that the Djaŋ'kawu are "concerned with procreation", while the Wäwilak are "interested in maintaining the status quo". He also claims that Warner "wrongly assumed that it [the Djaŋ'kawu myth] was merely one part of a larger cycle of stories centring around the movements of the ocean tides, and the floods of the rainy season".

The problem with such conclusions is that they assume to be *the* correct interpretation, when each is only one of a whole series of equally valid interpretations. It all depends on the level of keys one examines as to the interpretation of the narrative with which one is confronted, and no correct interpretation can claim to be more valid than any other correct one. In the Djaŋ'kawu complex there is the level that Berndt describes where the analogue is a sexual one. In addition to this there is a level of interpretation in which the myth is a record of the establishment of relations between clans, and another level which describes the movement of a cult across Arnhem Land. This is concerned with the progressive movement of cult objects in the form of anthropomorphic sculptures called Djaŋ'kawu from one clan centre to the next. When a connection is drawn between this process and the previously discussed movement of the different madayin from place to place, and it is recognised that this is frequently spoken of in analogical terms as the ebb and flow of tides or rivers, it is well feasible that Warner's (1958:335) analysis is an equally correct one.

A further interpretation is possible in which the story is seen as being the movement of spirit beings called Djaŋ'kawu across Arnhem Land, beings who establish a series of lesser beings (spirit children) at each site so that the set of these lesser beings at each site form the spiritual identity of the clan. This analogue includes a picture of Djaŋ'kawu, represented by the constant use of digging sticks to dig waterholes, copulating with the earth itself, so that the people being born are the spirit children which have Djaŋ'kawu as father and the "earth as mother". (Gondarra 1980). Berndt (1952:179) actually refers to one detail of this level without noting the distinction in levels when he says of the neophytes in the Njorra ceremony that "they themselves are the *rangga*".

Considered just from this relatively undetailed perspective, and counting the surface narrative as one of them, there are no less than five separate and equally valid sets of analogues. I would suspect that the last two described above are more inside than the others on the simple grounds that things of the spirit appear to be

considered to be of more significance, and therefore further "inside" than things of the flesh. However as I will attempt to show in later chapters associated with the Morning Star and its transformations, things are not as clear cut as that.

Over the years I have been given a key here and a key there with no straightforward explanation that says, "These are the keys to such and such an analogue". The result of this is that I am not able with any certainty to list the analogues in any hierarchical format if such a hierarchy does in fact exist²². However what does become obvious is that the sets of meanings are each analogues of the other, and each set understood amplifies the richness of the whole. Equally obvious is the fact that by the retention of the keys to any set of meanings it is possible to keep an analogue completely hidden. This means that control over the keys to the analogues gives complete control over the esoteric levels of religious knowledge.

Control of Religious Knowledge.

In traditional times the possession of and hence the control over religious knowledge was, in the Yolju society, equivalent to the control of that which formed the basis for authority. The end result of this is that a few powerful religious leaders held ultimate control. In present day North East Arnhem Land, these religious leaders still have a great deal of control in all spheres, but alternative power structures have developed and their control is no longer total. In this section I am considering the situation first from what is purported to be a pre-contact perspective.

Keen (1978:385) has argued that the main ingredient of the older men's control over the younger men is secrecy, but that that "secrecy would avail the men nothing if what they kept secret had no intimate importance" He also suggests a number of things which the older men control, that the secrecy enables them to maintain control over. These are: control of the representations which enable men "to

²² If keys are revealed to initiates for one analogue at a time it would be possible to consider this revelation of analogues in stages as a hierarchy, but this would not necessarily be a true representation of Yolju understandings.

tap the power of the Beings", control of the esoteric knowledge centred on paintings and songs, control of "physical access to major parts of public ceremonies" and "control of sanctions to guard the secrecy of the ceremonies". It is, he suggests (p386) secrecy which gives the knowledge of these things a value, and it is this value which "gives those who control it power over others" and that they are able to achieve this control over others, "by offering or withholding valued knowledge".

These things that Keen suggests the men retain control over by secrecy, are the things that give status and authority in both the "inside" and "outside" spheres. They are also the things that enable a man to enter into a full appreciation of and appropriation of his "identity". It would appear to be the desired access to these, and perhaps the fear of being deprived of them which ultimately provides the motivation for the younger men to submit to the older men's control. In the past, the control of religious knowledge was not the only sanction, and the use of physical violence, murder and sorcery appear to have been common means of backing up the authority gained by secrecy. Nevertheless it appears that the control of religious knowledge of various kinds was the most significant means of social control.

For any young man, upward mobility was only possible if he had appropriate patronage, and this was easier to obtain if his own father was a man of prestige. The position of greatest favour was normally that of the eldest son, though for various reasons, and not uncommonly, another son may be given priority. One young man told me that in his clan, his grandfather's eldest son (who had been the heir apparent) had formed a liason with one of the old man's wives. As a result, the grandfather had passed on the religious knowledge of all the sacred things to the second son. That second son was my informant's father. His father had passed on most of the knowledge to his eldest son, but as that brother was involved in inappropriate behaviour, my informant claimed that the knowledge (held in store by other older men) would eventually pass to him. This was as he saw it and not

necessarily true in the eyes of other men in the clan, but nevertheless gives some idea of how the system of patronage can function.

It is also possible to seek patronage as another man explained. If he wanted to gain knowledge, he would go out of his way to make a selection of gifts to a man whose knowledge he desired. These would include such things as meat from the hunt, well made weapons, turtle rope or harpoon, or even a canoe (considered to be an item of high value). He said that he would not ask for anything, but that the older man would consider the gifts and at an appropriate time would decide that, "I must teach that young man something". Nowadays such gifts can include such things as store food, cash, four wheel drive vehicles or even large inboard motor boats and younger men are beginning to count the cost of involvement in new ways.

More senior men are constantly watching less senior men, especially their own sons to see if they are behaving appropriately, or are "just rubbish" and one example of this is given in Chapter 4 where I describe the approach of a father who said that he watched his son to see if his behaviour was appropriate to warrant him being given knowledge at the first level. So it was in all aspects of Yolŋu society prior to contact. The old men's control gives the appearance of having been absolute. There was no alternative for a young man. Either he concurred or he was deprived of status and possibly even of his life. Nowadays control is not so absolute, except in the arena of traditional religion. The communities no longer have just the single domain of authority. Western government structures, based on the religions of materialism and capitalism, have been accessed by the younger men on the basis of their superior knowledge in this domain, particularly in English and Mathematics.

While, at Galiwinku, the young men still defer many decisions to the senior men, by having control over this new form of religious knowledge, they have become part of, and leaders in, an alternative power structure. In the communities there is now also an indigenous Christian church. Here again is another distinct power structure, with much of the knowledge accessible only to those who are literate.

In both these new structures there is still deference to the senior men. In both this has led to some personal conflicts. However in the church with the new experiences of the Adjustment Movement and the Revival both of which had a strong reliance on new revelations and on personal experience, the old men appear to have retained some authority while they depend on the younger men to do the work.

THE TWO REVIVALS.

In 1979 there was one revival, but now there are two. In that year the Revival began in a small fellowship meeting where, as it was described to me,

"We were singing and praying together when suddenly we all became aware of the presence of God, the Holy Spirit. We became aware of how sinful we were and how wonderful he was and we seemed to all begin crying, and confessing our sins and praising God all at the same time".

The excitement of that initial experience was contagious, and people in rapidly increasing numbers began to meet each night for "fellowship" with each other, but seeking also to experience this new revelation of the Holy Spirit²³. As these meetings developed, they took on a consistent pattern of beginning with an extensive time of singing of choruses that seem to be mostly of a "happy" type, and some of which were simply fun songs. At some point a leader introduced the second phase of the evening by announcing that the meeting would start. He would then lead those gathered in several choruses of a more worshipful type. Following these came any announcements, bible readings and teaching or preaching. After the preaching came the most important phase of the meeting. People were called to the front to form a circle, singing of worshipful choruses commenced and there was an expectation that during this phase of the meeting, the Holy Spirit would meet with some people. This was nearly always but not inevitably seen to happen as some moved to the centre of the circle, often weeping for their sin, or grieving over some member of the family who had not yet met the Holy Spirit nor mended their ways. Once in the centre they

²³ There is a great diversity of explanation concerning how the Revival started. The majority of versions however locate the original experience in some relationship with the evangelist Kevin Rurrambu and his family (See Bos 1988:72).

would be prayed for by one of the elders and then return to a place in the circle. This activity continued until there were no more people who felt the need to go into the circle for prayer and then the meeting was abruptly closed²⁴.

This with little variation has now become the structure of all "services" and "fellowship meetings". It is also the structure of the meetings at the annual "Thanksgiving Weekend", except that the second phase is extended by a succession of musical or dramatic items presented by a variety of clan groups or groups of visitors from other centres. It appears inevitable that in every case there are the three phases. First a phase which is treated as "before beginning", a second phase which contains all the types of activities that were common in a Western style church service, and then the third phase when the participants move into what can well be described as an experiential meeting with God.²⁵ With the Yolŋu understandings of the nature of transformation it doesn't appear to matter which terms are used in this context and there is no major distinction made between God, the Father, the Holy Spirit and Jesus, as there is an equivalence relationship between them.

The three phases of the meeting do not appear to have developed as a result of conscious choice, but I find it interesting that there is an almost exactly analogous structure in the qualities of these three stages and in the three major stages of transformation through which the Yolŋu progress in the passage through life (see Chapter 3).

When this Revival was at its height it was considered by most of the Yolŋu to be a unique experience. Now, however, as there has been time for reflection, a number of Yolŋu have begun to look back to the "First Revival". In doing this they are referring to events that occurred in 1957 which were called "An Adjustment

²⁴ Bos (1988:85f) gives more extensive details of the types of contents of these meetings, and a slightly different analysis of their structure.

²⁵ It would be possible to divide the second phase into three stages, identifying them as, prayer choruses, business and preaching, which would make the transformation structure a more complete fit, but as this would not necessarily reflect Yolŋu conscious ways of looking at the structures, I have retained only the obvious divisions.

Movement in Arnhem Land" by Berndt, who asserted (1962:24) that this was "primarily an attempt to integrate the 'traditional' Aboriginal world with the outside world", and that it had a "strongly political flavour".²⁶

This "movement", led primarily by three men, Batanga, Walalipa and Burrumarra, culminated in the bringing "outside" of a number of secret-sacred cult objects, to where they could be seen by all, and setting them in a concrete base adjacent to the church building. While Berndt attributes a primarily economic motivation to Burrumarra, and he appears to have been the least significant of the three prime movers, he quotes him as saying (p40) that,

The Bible came to our hearts and to our minds - it spoke of graven images, and we thought of our *ranga*. The word of God made us ashamed. Could we keep our laws? Could we hide our *ranga*? The bible was here. Instead we must show these *ranga* to all: to men, women and children. We must do this instead of hiding them. And we began to think of the Memorial.²⁷

In the current process of looking back the Yolŋu are linking what happened during the 1979 Revival to the events of 1957. It is interesting to notice here that this process of looking back to something earlier for justification and to authenticate the present was a process also going on in 1957. As the people brought out the *ranga* then, they claimed that they were restoring something that had been lost when the *ranga* were stolen by the men from the Djaŋ'kawu women. Berndt (ibid.66) records Burrumarra as saying that the following argument was used at the time, apparently to calm the women's fears,

It is all right for you to see these *ranga*. It's been too much on one side, only men and no women. They made this serious and shameful for women. But the old people are to blame, they changed a situation in which women could see these things and participate in their ritual. Before the old people made it what it became, the Lajindjun and the Djangawul had it for everybody

²⁶ My own interpretation of this would exactly reverse Berndt's interpretation in that it appears more to me as an attempt to integrate the outside world to the Aboriginal world by controlling the relations between the two.

²⁷ As I understand it, the Yolŋu use of the word 'Memorial' in this quote means simply a 'place to put the *ranga* in the open' and did not, and still does not have anything like the normal implication of the word's use in English.

In the 1979 Revival and in the current church situation it is worthy of notice that it is the sons of Batanga and Walalipa who have been the leaders, and that Burrumarra's sons have had comparatively little involvement even though they are half brothers to Batanga's sons, having the same mother. Batanga's eldest son, Daynumbu, speaking mostly in English attempted to explain to me how he saw the two Revivals as being related together in the following way,

One story about my own experience of the revival *bulu* (again) I was blessed by the Holy Spirit on that time in the time of Revival, and that was really blessing for me, to open up my heart to open up my eye, my spiritual eye, to see Christ clearly, and the Revival helped to fill me up with the *Dhuyu Birrimbir* (Holy Spirit) with, like that, excitement, that's what I experienced at that time. I'm just talking about my own experience on Thanksgiving Time. In that way the revival helped me but it also helped me to see the times of my own father, that those old people already have the same blessing as we have, it was the same blessing but it was only for a short time, those *liya-madayinmirri*²⁸ old people, they would get together and praying and singing and praying and singing they would, they would sing the hymns that the missionaries had taught them, from the methodist hymn book and they were very much blessed. It was like that for those old people they were very much blessed by the Holy Spirit. That was those old people's Revival. They had the first Revival, before we had the Revival. And you can see the differences. Their Revival they *dhawatmaranjäl* (made come out) the *madayin* (sacred things), *ranga* (ritual objects). They brought them out from the secret *ñarra* (secret ceremonial area), *räli* (to here), to the outside. They brought them out because God was using them, their *liya* (heads), their *djäl* (desires) their *ñayañu* (emotions), they would bring out everything.

This is what they were thinking, God was saying, if they bring them out then for the near future, then "Your children will be blessed too" like that. God used them in that way so that we would be blessed, therefore we received the second blessing in our Revival and they received the earlier blessing from God at that time. I was only little, young, before I was married, I watched my father preaching to those old people there, "And that the story for you all", and when he prayed he would raise his hands up in the air towards God *djiwarr'lil* (towards heaven) and after that he would pray. He wouldn't pray the way we do, my father (His name is Batanga), he used to put his hands up in the air before he prayed for the old people. And I saw what happened with them, they were blessed and happy and used them in different ways, they would feel the presence of God there. I saw it. This happened when I was still young and I didn't understand it. I was very young. It was exciting with them and some of them were crying together when they received the blessing from God. And that's the story about that time and we should see it.

And from this time I experience two Revivals, the Revival of the old people and now this time has a different experience he came into me because in the first one I didn't have the experience that they had those old people because they were *liya-ñarramirra mala* (the ones having understanding of the secret ceremonial ground), *liya-ranga'mirra mala* (the ones having understanding of the sacred objects), and this time we received *bulu* (more) good blessing from God, that we all received, this time. And this time we all received the blessing, all the people. The difference is this, that just the old people were blessed in those

²⁸ literally head full of sacred things, knowledgeable about such things.

days, just the people who got the *maḍayin* (sacred objects) and the *liya-ṅärramirr walal*. (the ones having understanding of the secret ceremonial ground). Only those was blessed in those days. This time at thanksgiving time everyone received the blessing, *Dhuyu Birrimbirriy* (by the action of the Holy Spirit), everyone, children and big ones and babies and women and men and white people and everyone here at Galiwin'ku. And these are the two differences.²⁹

This process of adaptation/adjustment still continues in what appears to be a conscious process of continually rethinking ideas to match Yolḅu intellectual understandings to current experience and practice. In the following quote, Rev Djiniyini Gondarra describes how he, as a leader in the Northern Synod of the Uniting Church, is constantly involved in doing just this.

The missionaries³⁰ said we have to leave the Yolḅu way and follow Jesus, but that cut people off from their identity. The Spirit challenged Paul about whether he was living like a Jew or a gentile. People respect my leadership because I separate between what the gospel says and wrong practices. For example, I enjoy traditional dancing and Christian dancing but I will have nothing to do with the Gunapipi [one of the rituals associated with the Wäwilak] and its sexual immorality.

I am trying to contextualise Christianity into Yolḅu society. The white contextualisation of the gospel becomes a bondage to Yolḅu. The Lord opened my eyes to see that hidden context.

I have been to Canada and Indonesia looking at contextualisation.

Congress is not for hit and run evangelism but rooted into the life of the church. Need to take a new approach.

It took a long time for the church to recognise Paul. Christ saw the value in people, but people don't see that they have something to give.

It would appear from the above that the two revivals were, at least from the Yolḅu perspective, genuine experiences of reality, which for them meant experiences of the inside reality that has always been. In 1989 there was continuous effort on the part of at least some Yolḅu to assess the relationship between what the old people did in the "first revival", their experiences of the 1979 Revival, and the ongoing course of the "bringing outside" and in a sense the desacrilising of previous "inside" elements. The new experiential knowing of the Revival is now being freely and openly placed alongside the earlier knowledge of the ancestral beings and there

²⁹Berndt (1962) appears to have either ignored or missed the aspects of the 1957 events which are here described in terms of a genuine religious experience, and concentrated on analysing this First Revival in terms of social and economic aims.

³⁰ the word missionary in this context was used as a generalisation for non-Aboriginal Christians.

have been a series of attempts on the part of Christian Yolŋu to re-interpret the old in terms of the new.

CONCLUSION.

In this chapter I have sought to highlight Yolŋu perceptions of the inner aspects of the cosmos. This has been shown to be concerned with an inside aspect of reality which the Yolŋu recognise as having been revealed to them in the past through experiential contact. A variety of entities have been discussed in association with this. Some appear to exist in a state which overlaps both the outer and inner dimensions. Thus "children" are both unformed, pre-identified humans and freely communicating intangible beings, and *mokuys* are both post-death humans and independent intangible beings. Other entities such as *waŋarr* and "totems" appear to have a normally intangible form, made tangible in special ceremonies. Among these latter, *waŋarr* are known to have distributed amongst the clans, sets of objects which are representations of themselves, and of lesser spiritual beings whose most outer transformations are conceived of as being the natural species or various artifacts of everyday life.

These representations then function as tangible evidence which should only be handled, seen or refurbished in situations with an appropriate degree of secrecy and respect. Such representations are linked to spiritual entities associated with particular sites. Ownership of such representations is then incontrovertible evidence of ownership of the related site. Shared ownership of related or similar representations forms the documentation of relationships between clans and such relationships are able to be established on the basis of an exchange of such representations. One implication of this exchange, is that as the spiritual entities of the inner side of reality can be both caused to manifest at ceremonies and also to be exchanged between places, then man is able to a certain extent, to control contact with, and the movement and manifestation of such beings. Once a relationship is established by such an exchange the logic of an unchanging eternal verity enables the interpretation that because a thing has been established it must be a manifestation of

the unchanging inside of reality and therefore is not a change but a manifestation of what always was so.

Most valued for their function as a means of coming into relationship with the spiritual entities and one's own eternal destiny, the objectifications called *ranga* are also the embodiment of layered meanings and of understandings of life itself, of the relations between clans, between the sexes, between mankind and the land, and between mankind and the inner side of the cosmos, and these aspects are all explored in the following chapters. The control of the layered meanings embodied in analogical reference, and its release on a gradual basis to men as they grow older, appears to be the basis of the control structures of Yolŋu society. It enables the maintenance of control in the hands of a small number of senior religious specialists.

The most recent Yolŋu experiences with the inside of reality through the two Revivals has led to a whole new series of understandings of it, and has caused some Yolŋu to reach radically new perceptions of it. Some Yolŋu have attempted to maintain a complete dichotomy between Revival experiences and traditional ritual, while yet being involved in both, some have remained completely aloof from the Revival altogether, while still others have tried to achieve a synthesis between them. The existence of the inner side of reality of the eternal cosmos has never been challenged. What is in question in Yolŋu society is its nature.

CHAPTER 3. THE PASSAGE THROUGH LIFE.

INTRODUCTION.

Whole and Part.

Notions of Life and Living.

The Transformation of Living Things.

HUMAN LIFE CYCLE.

THE "RELIGIOUS" LIFE CYCLE.

EXISTENCE BEFORE HUMAN LIFE.

THE HUMAN LIFE CYCLE.

LIFE AFTER DEATH.

Where do the dead go?

The Journey to the place of the Life after Death

The Nature of the Afterlife.

Processing the Dead

CONCLUSIONS.

THE PASSAGE THROUGH LIFE.

INTRODUCTION.

In this chapter I consider the passage of the individual through society from pre-conception to post death and in doing so, demonstrate and expand on the relevance of cosmological perceptions discussed in the two previous chapters. I also examine some conceptual areas that are relevant to this passage through life. The new conceptual areas are those concerned with "whole" and "part" and "life" and "living". Together with some aspects of the way living things are perceived to transform over time, these are critical to the understanding of the later discussion. The discussion moves from them to ideas of pre-conception existence, and then follows sequentially through various stages of Yolŋu understandings of the life cycle. This examination includes an analysis of the analogical references to the life cycle contained in a myth about the manufacture of turtle rope and its use in the hunt. Since this was first published (Rudder 1980: 37) further understandings of its content and reference have become available and these are explored here.

Whole and Part.

There appears to be a notion of equivalence between any item and any part of that item. This was first explained to me during a discussion with Yolŋu teachers some years ago concerning the teaching of reading. We were trying to find a way of describing, in the Yolŋu language, the process of building words from known syllables. The word *wakana* was proposed by one of them as a possible translation for "syllable" with its meaning as "a part" of something. It could be used to refer to a part of anything such as a segment of an orange, part of a vehicle, or of a word. However, in attempting to describe the process of putting *wakana* together to construct new words we encountered a serious obstacle. Each *wakana* retained the identity of the word from which it had been separated, so describing the process of word building in

this way, and using the term *wakana* to do so, was akin to trying to take two totally different identities and put them together to form a completely new identity which had nothing to do with the identities from which it was being constructed: a conceptual impossibility.^{1a}

As the concept was described to me, "You take a stone, break off a piece. The piece is *wakana* from the main stone. Maybe break off five or three or four *wakana* off the stone, but all are the same." It could be applied to people, "father, son the same *wakana*, body, face, foot are alike". This appears to be referring to the family likeness which is seen to be patrilineally inherited, and both father and son are *wakana* of the same patrilineal "identity". The concept incorporated in the word *wakana* (a word not very widely used) has a very wide application, for it helps to explain the ways in which parts of anything are understood to be equivalent to the thing of which they are a part.

The concept of equivalence between part and whole becomes relevant in regard to the discussion of the human being and parts of the human. For example one speaks of I (not my) name and I (not my) arm and so on. The notion of the human spirit and human identity as each being part of and therefore equivalent to the individual has particular relevance to this chapter. In other chapters the importance of equivalence relationships between ancestral beings, traces of them left in the landscape, and the ceremonial objectifications of them of different types is obvious. This is not quantitative equality but qualitative equivalence.¹

It is a simple matter following the Yolŋu approach to perceive any part of a man, visible or invisible, as able to function separately in any one of the

^{1a} This notion of a permanent relationship between any whole and its parts is different from the perception of a whole made up from a number of discrete separately isolable parts each with its discrete identity and each being able to be recombined with others to form a new identity.

¹ This understanding of the relation between whole and part, when combined with the earlier discussed notions of transformation provides, at least for the Yolŋu, a solution for the problem which occupied so much of Lévy-Bruhl's struggle to explain the logic of what he called "participation" (1910 and 1975).

transformations that make up his identity, without any consideration that there has been a change in his identity. Each transformation is him and he is each. Ramifications of this concept associated with a group's identity and of an individual's identity in such a group, whether it be clan, patriline, site or totemic affiliation are obvious. Each is part of the whole, but each simultaneously is not just a representative of, or identified with, but a manifestation of the other.

Notions of Life and Living.

It is too simplistic to suggest that the Yolŋu distinguish a neat dichotomy between living and non-living, and when they do actually use these categories there is no neat correspondence between their use of these classifications and the way that the terms are used in English. Meaning, for each of these categories, is made neither clear cut, nor bounded, but is contextually determined. Inanimate objects in some contexts can be considered as having a quality of life that is outside the normal Western category of living. Similarly animals can be seen to have life which is more than animal in certain contexts (see below) and humans continue to exist when physical life ceases. Again, that which is dead can be simultaneously understood to be alive with a different quality of life from that perceived in the normal classifications of living. There is however no clear distinction made between physical life and spiritual life (or outside life and inside life), except through context. Thus the dead are dead, but still alive in the sense of having transformed to the inside of existence. The effect of this lack of a clear cut boundary between these two qualities has a range of results.

I have demonstrated (Rudder 1983) that the Yolŋu distinguish a series of categories of different qualities of "living" which are reflected in different classes of living things. These are classifications which apply to the "outside" existence in the physical world. There is also what appears to be an indistinct awareness of a quality of living which applies to "inside" existence. Inside existence is a concept of a quality of life which overlaps or potentially overlaps all the other categories. The normal or

outside categories of living things that are used, while not lexically identified, are clearly distinguished by the Yolŋu by describing their attributes. Considered in order of increasing complexity, these are identified by the Yolŋu as follows, (the terminology for each category being my own).

- "Non-living" = "those things which do not move themselves", including the shells and bones of things that were once alive.
- "Life-having 1" = those things which have movement or the power to affect humans, including the sun, rain, vehicles, fresh water, the sea and fire.
- "Life-having 2" = those things having "the ability to breathe or to reproduce", including all plants and animals. (most of which have "tails")
- "Life-having 3" = the life of humans who have emotions, are able to forgive others, and "have and keep laws while animals do not".

One further category of living relates to the quality of life relevant to the "inside". It, like the others, is not lexically marked nor is it distinguished frequently by more than context. Frequently it can be more consistently identified by implication than by overt reference. While this implication is frequently carried through analogical reference, the "inside" category of living extends beyond the extremes of the other categories as well as overlapping all of them.

The Transformation of Living Things.

Plants and animals are recognised as having patterns of transformation linked to their cycles of reproduction or replacement. The patterns are classified in different ways. The stages are related to identified physical changes in appearance and may be lexically marked, described by colour changes or identified by relating them to changes in seasons or to other concurrently observable changes in the flora and fauna. For example, Figure 3:1. illustrates Galpagalpa's description of the life cycle of

warraga (the cycad palm, *Cycas media*) as it goes through the stages that he recognised. In these there are three stages of maturity of the fruit on the plant and a further three stages of fruit on the ground as it transforms from its state as a fruit to assuming the state of a young plant. Throughout the full cycle it is known by the general name for the plant, *warraga*, so that while each stage is separately identified and some are separately named, each is perceived to have its own characteristics, yet all stages are still *warraga* and do not change from that.

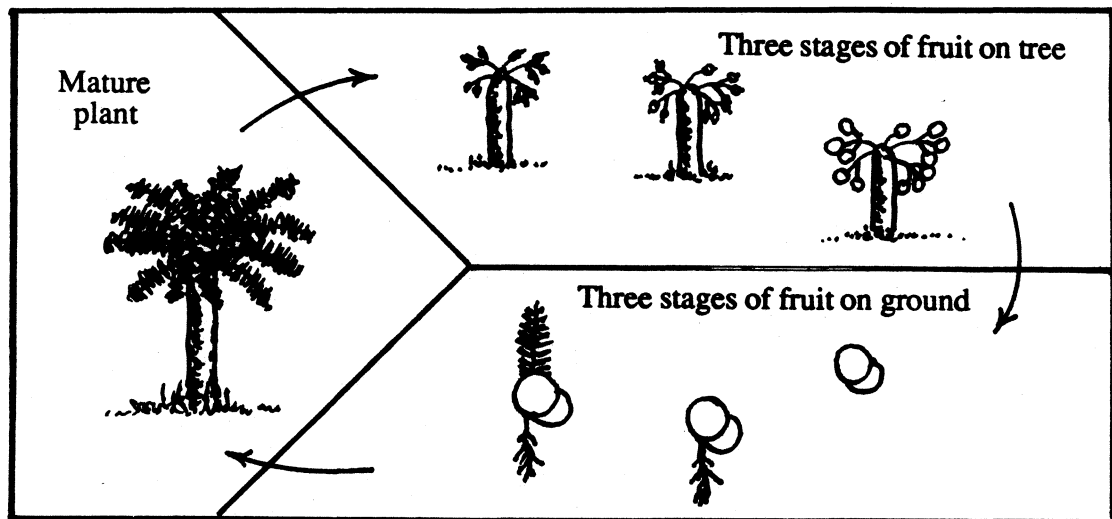

Figure 3.1. Life cycle of the cycad palm

Such tri-partite structures of classification were also shown to be used in classifying the perceived life stages of four of the five species of turtles, the emu, and at least one of the edible yams. By classifying the separate stages and considering each as a transformation of the other rather than a series of points along a continuum, the process of steady growth and change is classified out. When this is done it is possible to consider each separate stage as a separate and different manifestation of the one unchanging identity, a process facilitated by the notion described earlier whereby whole and part are seen as in an equivalence relationship to each other.

Where anything is recognised as moving through a transformation from one state of existence or expression to another, it potentially has a series of successive

named stages of development to the maturity (or completion) of any expression. Where such stages are recognised it appears inevitable, judging from the records I made, that for each expression there will be three and always three categories of assessment within that expression, then beyond those three a transformation to some new category. Examples of this three fold transformation of identity, as they apply to the maturity of natural species are given in the three central columns of figure 3.2, where each of the three stages is identified by a separate term

The first column represents the perceived preexistence of an identity, before it enters the outside or physical expression being considered in the classification. The second column contains the first stage of the expression, and, for the species where there was an egg before this stage, this stage is represented by a hatchling. The central column represents a stage where the adult characteristics are present but incomplete, and the fourth column contains the classification for the fully mature stage, so columns two, three and four represent stages one, two and three of the ordinary "outside" categories or stages of "living".

Before Outside Life	Stage One	Stage Two	Stage Three	Beyond Normal
mapu egg	gadarrkadarr stripy hatchling	marrwawul immature	wurrpan adult Emu	wurrpan
mapu egg	walanju	rrew	dhalwatpu Green Turtle	dhalwatpu
mapu egg	bandamirr	dayday	garriwa Flatback Turtle	garriwa
mapu egg	matjindi	watjidika	garun Loggerhead Turtle	garun
	yuthuyuthu infant	batawanaju	warranaka adult Dugong	warranaka
	dhunguruk	djalpinyju Gardenia megasperma	dilkurruju	any of terms.
	munuymunuy	djengana	barrukala Paper bark tree	barrukala
	gamuruju an insect larva	burrpal pupae	miyuru adult	

Figure 3.2. Classifications of maturity stages of natural species.

The last column represents an entirely different kind of transformation. This last column represents the classification of a different quality of "living". While it is still named by the term for the adult, and still has its identity, it has something about it which is beyond the normally expected focus of the ordinary categories, having about it something of an anomalous state. An entity to fit into this column will have the outward appearance of one in stage three, but will also demonstrate other characteristics that indicate a transformation in the focus of its identity. For example, an extremely large specimen may be perceived to be not just an animal or plant, but simultaneously the presence or image of an unborn human being looking for its mother to be. An animal that walks right into the camp and so displays human characteristics even to the point of eating offered food is likely to be considered to be the image of someone recently deceased. In either case, it is in an anomalous state of being both animal and not animal. In this way that the focus of "natural species" categories are able to some extent to slide into the categories of "human" while still retaining their species identity.

In all these cases of transformation the focus of the naming process is on the naming of and the "identity" of the species rather than on individual specimens. The individual is simply a representative of the species. This appears to be the same as the process in English, however the notions of whole and part are involved in the Yolŋu approach, as is the absence of both definite and indefinite articles, and the almost complete irrelevance of number.²

If a particular tree is sacred through contact with ancestral beings or as a trace of one of them, the question arises as to what happens to this sacred object when the tree dies. The answer is that when one tree dies, it is not the identity that dies,

² Very few nouns in the language have a discrimination between singular and plural forms. For example each cycad tree in a grove is *warraga* and the whole grove is *warraga*, what is named is simply the identity of a species, or a better way to say that is to speak of the species having an identity and in this case it is named *warraga*.

simply one specimen of it, and the sacredness will, over time, be automatically attributed to another specimen of the same identity. In this way there are pandanus trees (a relatively short-lived tree) associated with Banumbirr (the morning star) and others with the Djan'kawu that continue to be associated with those entities long after the original specimens would have died. The identity continues through periodic seedling replacements in the ongoing unidirectional transformations of the identity.

The human life cycle is in a similar way broken into a series of recognised stages. Some of these are lexically marked and the transitions between them are, or at least appear to be, socially acknowledged through rites of passage. There appears however to be no totally clearcut relationship between the recognised physiological or social stages of development and those stages of ritual status which are the potential for any individual male, although this relationship seems to be implied by Warner (1937/58:125-137). It is to a consideration of these recognised stages of transformation of the human life to which the remainder of this chapter is devoted.

HUMAN LIFE CYCLE.

Before one can consider the Yolŋu perception of the human life cycle, it is necessary to remember that here also there are notions of both an "outside" physical life and an "inside" life. It is possible to identify from a variety of sources statements that indicate that an individual's life is considered to exist prior to conception, and that growth continues after death.³ It is also possible as Warner does (1958:126) to make a separation between a man's ordinary life and his ritual life. He gives two tests for a man's status in each of them. I outline these two different ways of looking at the life cycle briefly before considering some of the aspects in more detail.

³ Stages that are of significance in a ritual sense are represented analogically in myth and in a consistent pattern of rituals that celebrate or denotate those stages of maturity that are of religious importance.

Conception, is noted in a number of sources (see the following sections) as having two different aspects which are usually described in terms such as physiological and spiritual. The Yolŋu are not ignorant of physiological parentage, though in conversation they tend to ignore it and concentrate on what to them are the more significant religious ideas relating to the establishment of identity.⁴

Childbirth, traditionally women's business is normally now a hospital occurrence and a child is as likely to be delivered by a male nurse or doctor as by a female nurse or doctor, a situation which currently appears to be accepted as normal by the whole community.

Early childhood appears to be the time of life with the most differentiation of physical stages and the time of least focus on religious significance. The stages of childhood growth that I recorded are listed in Figure 3.3.

<i>gulunŋur ŋāndiwal</i> =	in mother's stomach
<i>yutjuwala ŋorranhamirr</i> =	little, lying down.
<i>yutjuwala bilyunamirr</i> =	little, turning.
<i>yutjuwala nhinhanhamirr</i> =	little, sitting.
<i>yutjuwala gal'yunamirr</i> =	little, crawling.
<i>yutjuwala rur'yun ŋayi dhu</i> =	little, getting up it will.
<i>yutjuwala djan'tjanthunamirr</i> =	little, toddling/staggering.
<i>yutjuwala marrtjinyamirr</i> =	little, walking.
<i>yindin mirithirra wandirra</i> =	big, strongly running.

Figure 3.3. Stages of child development.

⁴ Warner (1958: 23, 24) found this emphasis on the religious perceptions so consistent that in his first field trip he completely missed the fact that the Yolŋu clearly understood the physiological aspects of parentage.

Each of these identifies a different stage of progress towards independence and mobility.⁵ This is a period of immaturity where the sex of an individual is of minimal significance. In terms of stages of physical life or socially recognised stages of life, both sexes are seen as passing from childhood, through puberty to become unmarried adults, then *wāgamirr* (home/place having), a parent for the first time, a grandparent for the first time and as finally reaching old age and dying, after which they will go to the place of the dead.

Hypothetically these physical stages coincide with the stages of ritually established religious seniority, referred to in the literature (e.g. Berndt and Warner) as age grading.

THE "RELIGIOUS" LIFE CYCLE.

The Yolŋu religious outlook proposes that life exists prior to conception. Ritually, it begins at conception and from conception on, the newly found human has entered childhood. The end of this childhood is marked differently for male and female children and with that demarcation, differentiation begins in the use of terminology to identify the successive developmental stages of the two sexes.

For the male the end of childhood is marked by the *dhapi* (literally foreskin) ceremony, during which the child is circumcised. Throughout the ceremony he is known as *mel borum* (lit. eye ripe) up until the cutting takes place. After the operation, he is *moḍan* (circumcised) and the new term applied to him is *gurrmul* (young single male). At this stage he begins to learn self sufficiency and to become a provider, and learns to demonstrate to the satisfaction of the older men that he is one who keeps to the *rom* (the ways of his people). When this has been achieved, he will

⁵ While these stages are all descriptive phrases and are recognised as such, some of the terms are used as though they were classificatory stages of development. Throughout all these stages, and until the end of childhood is reached at puberty, the word applied to these young humans is, *yoṯu/gurrulk* (child) or *djamarrkuli* (more than three children).

be accepted as an initiate for the *ḡarra* (sacred ritual ground and ceremony) and only after this is he a *ḡirramu* (man) and able to marry. In traditional or precontact terms, until this ceremony had been performed all legal access to women was denied. In later life he will be *worruḡu* (an elder) and may become known as *liya-ḡärramirr* (lit. one who thinks about the ceremonials), be a ceremonial leader, and in some cases, equivalent to a magistrate who arbitrates and makes final decisions about disputes and their settlement.

For the female the end of childhood is traditionally marked by the *milingirri* ceremony at the onset of her first menses after which she is known by the term *wirrkul* (single woman). I have not been informed of other ceremonially marked life stages for women but a number of changes in the terms used refer to socially observed stages of maturity. These are; *wäḡamirr* (literally, home-having) which refers to any woman who has a husband and hence a home unit of her own, *yothumirr* (literally, child having), that is a pregnant woman, and then *ḡuḡman* after she has given birth to her first child. Two other stages described as being of real significance to a woman are when she becomes *märi* (M.M to a D.Ch) and *märi'mu* (F.F.Z. to a B.S.Ch.). As she becomes elderly, usually after at least one of the two grandmother categories have been attained she will be known by the same term *worruḡu* (elder), as is applied to senior men. That, in brief outline, is the religious life cycle.

Warner (1937/58.130-31) says that,

Age grading in Murngin [Yolḡu] societies is highly ritualistic and controls a man's religious life far more than it does his ordinary daily existence. The initiations elevate him from a lower and more profane existence to a higher and more sacred plane and mark his transition from one age grade to a higher and older one. Age grading then, controls the degree of sacred participation a man has within the community.

In saying this he speaks as if the stages of progress are rigidly established along a continuum. There *is* a continuous increase in a person's attainment of religious knowledge and status; however while there are some clearly marked major steps that

can be taken, revelation appears to be as much a continuous process as a series of age grades and nothing is quite as neat and tidy as Warner makes it sound. Having said that, for the purpose of description I have identified some sections of the religious life cycle and will examine them one at a time. These are: existence before conception, the passage through physical life as a ritual progression, and death and the afterlife.

EXISTENCE BEFORE HUMAN LIFE.

As mentioned earlier the individual is understood to exist prior to conception. Williams (1986:31) says that "Yolngu believe the spirits that animate foetuses are always at, or come from, specific places, or both", and the notion of existence in a location is widely agreed with throughout the literature.⁶ However the idea that it is a spirit that animates the foetus needs some clarification on two points. Firstly there is a word *birrimbirr* which refers to a continuing aspect of a person after death. This is commonly and inadequately translated as "spirit" or "soul", but I have not heard this word used in association with pre-conception experiences.

Traditionally it is of significance to the Yolngu to have a recognisable external sign or experience by which a conception can be identified. However what is described as coming is either the child (*yothu*), its image (*wunuli* or *mali*), sometimes in English as the baby's spirit, or some transformation in form that is considered to be the child. Secondly, it is described as coming to its father or mother or both but is not described as coming to the baby (foetus), an impossibility considering that it is the baby.⁷ This interpretation agrees with Shapiro (1979:9), and Warner (1937/58:132) notes that,

The Murngin baby comes from the totem well through a religious experience of the father, The father's mystical dream experience is a kind of rite of passage of the unborn and begins the child's socialisation.

⁶ For example Warner 1937/58, Berndt 1964/68, Peterson 1972 and Williams 1986

⁷ It is quite possible that this way of referring to a child coming was what initially persuaded Warner that the Yolngu were ignorant of physical conception.

After collecting a number of stories concerning conception experiences I attempted to clarify this issue during a recorded interview with Rrurrambu, one of the leading Arnhem Land Christians. Part of this interview I include below. It begins with my proposition and leads to some interesting explanations of the Yolŋu understandings of pre-conception existence. Also expressed are some clear understandings of the transformations of the form of existence without change of identity. With all the clarity of expression it also demonstrates that the edges of many of the ideas are fuzzy or unbounded. For example, what comes to the father is not a spirit, but is the child's image, the child's spirit, an animal or fish, all of which are treated as synonymous.

J.R. I have heard that the spirits of the children are there in the country in a special place before they come to the mother to be born. Is that the true story?

Rr. *Bäyŋu* (nothing/ not so), no such spirit in the land before birth.

J.R. What is it that comes to the father?

Rr. *Yothu wuŋuli ŋuli malŋ'thun bäpawala* or to *wiripuwala yolŋuwala*. (The child's *wuŋuli* [image] will appear to the father or to another person). It isn't there, but it comes at conception or just before. The spirit of *yothu* (child) indicates to parent (either) or to someone else. Normally to father. Just an indication that baby is on the way.

J.R. Where does it come from?

Rr. Comes in many forms, maybe in form of animal or marine life. When someone gets something special like dugong or kingfish. Or father might get a bigger catch than everyone for the week. The mother will tell (her husband) that she is pregnant. When he or the other person looks back, he can say "Oh yes that was the significance of that".

J.R. What about the idea of being alive before being born?

Rr. There is a reference made by some people to water. You hear people say something like, "*Narra gan nhinan ŋäthil ga yurrnha nheny dhawal-guyaŋan, gapuŋur yan*. (I was here before you were born, when you were just in the water. I don't know if they mean that the younger one still existed in the water or whether they mean spirit. I think they are referring to semen, because we call it *gapu* (water) and *wiyika* (liquid).

J.R. Can you give me an example?

Rr. Just before I was born my father went out and speared a very big dugong. The very next day, my mother started to feel that she was about to have me. (She hadn't become aware that she was pregnant before that). That doesn't give me a dugong spirit, but puts me into a category that claims all *miyapunu*. (All marine mammals plus sea turtles). I was in the area when my father speared the dugong. I was in the form of dugong in that area where people who claim the land, claim the whale totem.

J.R. That says you were there before you came to your mother?

Rr. Yep. But whale is too big for the area where father found me so I became a dugong.

J.R. Are you dugong now?

Rr. No. *Wuymirri* (whale). I became whale because that's the country where I introduced myself to my father. I can claim whale totem, and negotiate with any other people who claim whale totem in any other part of the country.

J.R. What are you?

Rr. I'm a person

J.R. What were you before you were born? A person or what? a whale?

Rr. I was still a person before I became an animal. It's a process just the same as you see in nature. Butterflies come from cocoon but also from caterpillar.

J.R. They are different things or the same?

Rr. They are the same.

J.R. In what way?

Rr. The process of changing from whatever it is to something else.

J.R. What is it that's changing?

Rr. It doesn't change what it is. It only changes form. It's still the caterpillar, it's still the butterfly. It changes, but it's still the same thing, the same identity.

In the harpooning of the dugong by Rrurrambu's father we see a good example of what Warner (1958:23) calls an "extra-mundane experience" by which a child indicates its presence and is recognised before conception. While Warner suggests that this indication is always given to the father, and this appears to be considered normal, there is not any total consistency and it may be the mother or another member of the community who has such an experience, or there may be no experience at all. In the following excerpt from an interview with Mawunydjil there is one example of a father's experience, one of a grandmother's dream, and a listing of four out of six children of the one couple for whom there were no signs noted.

M. If one of our children ask we will say they were bird, or fish, or turtle, or *maypal* (shellfish) or *warrakan* (animal) before they were born. Second is sign will happen for a man or a woman. They see the sign and then the woman will be pregnant. That's the *nāthilipu* (of the past) story.

Nimanydja (Mawunydjil's wife) and I were in Darwin in 1974, and we went hunting for wallaby. We had two children at that stage. I saw a python there. I thought it was a tyre or wood at first. I threw a stone at it and it moved. I called Nimanydja and my sister and they saw it too. We stopped looking and talked and it disappeared, but we didn't go looking for it. In three or four weeks time Nimanydja found that she was pregnant, and we knew that that *bāpi* (snake) was a sign of the baby coming. When the baby was born we gave her the name Banbaniwuy. Later the family said that's the meaning of python.

J.R. Did anything happen like that with the others?

M. 1st baby in Melbourne. Heard footsteps in the room and actually saw footprints on the wooden floor they were like wet footprints in that you could see them on the floor. For the second, fourth, fifth, and sixth ones there were no signs.

There are other signs that a woman is pregnant. There is the sign of the woman wanting to eat too much like *maypal* (shellfish). People will say to a woman like that, "*Nhā nhe yothumirr?*" (What's this? Are you with child?) Sometimes there is the sign of vomiting a lot, and sometimes their face changes.

Nimanydja dreamed of finding a fat baby boy and of showing him to others in the dream. I thought a miracle was coming for me [because all the first six children are girls], but then our daughter told us she was pregnant. The baby she had was a boy and grew big.

In traditional thinking a baby comes from sea, wind, tree. It's just there, for a long time, some people believe that the baby is there now swimming in the sea with fish and turtles and stingrays. They are not those things. Don't know what they look like.

When I see a big turtle, I can spear it. The baby spirit, (not a turtle spirit) will come to me, and then when I kiss my wife, the spirit goes to her. Can see on a baby the birthmark where the turtle was speared.

I can believe these things because of my own experience.⁸

Included in both Mawunydjil's and Rurrambu's observations is the clear indication that the child is assumed to be existing somewhere before it comes to its mother. There is also demonstrated in Mawunydjil's comments an expectation that there is likely to be further proof of the baby's identity presented through some mark on its body, a mark that can be related to the treatment given to its "image", such as a birthmark which relates to where the image was speared.⁹ This expectation is also referred to in the story from Maratja recorded in the following chapter where Maratja refers to himself as having minimal body hair because the hair was scraped off the yam that was his conception indication.

As far as which parent contributes what to the conception of the child, Berndt (1964:121) says that,

"the father contributes the child's bone substance, the mother its blood and flesh." He then says that, "the bones are likened to sacred emblems of *rangga*" and that "these objects come down to a child in the paternal line just as his bone substance does".

This is not however the most accurate representation of the Yolŋu notion. A Yolŋu person uses the one word, "*ŋaraka*", for bones, for the sacred emblems (the *ranga*), and in some contexts for his own identity in relation to the *ranga*. He also

⁸ Mawunydjil makes the comment that the baby spirit is transferred from the father to the mother with a kiss. However it should be recognised that the context of the conversation has a bearing on the meaning. I as an ex-missionary teacher from Elcho am in this situation interviewing the man who is the ordained minister of the local Uniting Church. It seemed so obvious in the situation that this was a euphemistic reference to a sexual relationship that it never occurred to me to check.

⁹ See also Berndt 1964/68.122 for a similar concept that he recorded finding at Balgo in the Kimberleys.

speaks of his *wāṅa ṅaraka* (literally place bone), the site to which he is patrilineally affiliated and which is part of his identity. As Peterson (1972:17) says there is a

link between a man, his bones, his animating spirit and his country [which] lies at the heart of men's sacred ritual.

The Yolṅu makes little discrimination between these different uses of the term, for each is in an equivalence relation to the other and seen as simply a different revelation or transformation of the one identity as discussed earlier.

When this understanding is then applied to the first part of Berndt's statement (above), the information given can then be taken to mean that "the father contributes the child's identity" which includes his bones, his *ranga*, and his spiritual affiliation with land. That which is the foundation of his religious identity.

THE HUMAN LIFE CYCLE.

Usually well before puberty, and somewhere between eight and eleven years of age (Williams 1982:199) a boy is circumcised.

Each circumcision ceremony is a unique event patterned according to the identity and relationships of the individual that the ceremony will *gurrmulkuma* (make into a *gurrmul*, or circumcised unmarried male) and of those conducting the ceremony. In whatever form it occurs, the *dhapi* (foreskin) or circumcision ceremony marks the first step of a male Yolṅu into the religious life as an individual. It is currently possible that a man can live his entire life without making further progress in the religious life for a variety of reasons. These may range from his personal behaviour being unacceptable to the religious community to a choice as part of a Christian lifestyle not to follow the traditional religion.

Considering the normal traditional progress, Warner (1958:125-137) lists a number of rites of passage which mark the transfer from one level of age grading to another as follows; "birth", circumcision, seeing the low totems, seeing the high

totems, and death with its involvement in mortuary ceremonies of various kinds. The first of these occurs before birth, and the last occurs after death.^{10,10b.}

The Djambarrpuyngu clan describe the life cycle analogically using a myth about the construction and use of a turtle harpoon rope in which the rope, constructed of spun fibres, represents an individual and his/her identity made up of many interwoven aspects¹¹. In Rudder (1980: 37-47) I recorded two versions of the myth (see Appendixes C and D), both shared with me by Djorrrpum. These were a narrative version, and a song version, from which I extracted a structural analysis and sought to demonstrate "the richness and depth of meaning of Yolngu mythology". Most of the following interpretations of the analogues came from Djorrrpum, however discussions

Analysis of the Myth.				
Paragraph	Song Contents	Additional Contents in narrative version	Man's State	Action performed at end of stage
1.	Non-verbalised singing	Collection of pre-existent materials Fibres connected to forked stick	Pre-existence of spirit.	Conception
2.	Commencement of spinning	Crossing over forked stick	Growth in womb.	Birth of Child
3.	Rope coiled on ground	Peeling of bark	Childhood	Circumcision
4.	Growth to needed size and piling up "bones"	Connection to float and harpoon	Manhood and Physical equality to father.	Initiation (following up the madayin way)
5.	Rope coiled in canoe.	Rope retrieved from water with turtle	Marriage	Spirit conception of first childz
6.	Rope coiled in canoe. Turtle also in canoe	Rope and turtle taken from canoe	Wife pregnant with first child	Birth of first child.
7.	Rope coiled on beach with Mukarr	Detachment from float and harpoon	Growing unity with ancestral being	Final mysteries revealed Contemplation
8.	Rope lying still.	Recycling of fibres	Fulfilment.	Death.

Figure 3.4. Structural analysis of the turtle harpoon rope myth.

¹⁰ As Warner summarises, (ibid:132) "The father's mystical dream experience is itself a kind of rite of passage of the unborn and begins the child's socialization. The father's announcement to the mother of the child's arrival changes the father's age-grade status. ... his first child's 'birth' effects the father's spiritual birth into a recognised higher status in the community age grouping, and simultaneously the new being is taken into the lowest age grade. As an old man, the Murngin learns the final mysteries of life by seeing the most esoteric of the totems. Ultimately he dies and assumes a new social status, and by the mourning rite of passage enters his last social grouping".

¹¹ See also text quoted from Djangirrawuy in Chapter 2. In his discussion of ancestral power, where string/rope is equated to m^ärr (desires and feelings)

^{10b} The structural analysis of this myth bears a clear relationship to Lévi-Strauss's analysis of the Story of Asdiwal (1967:1-47) in that both analyses demonstrate that the different levels of interpretation can be seen to have "an underlying logical structure common to all of them": and that the comparison of different versions reveals information about each of them.

of the contents of that article with the Yolŋu since it was published have revealed that there is considerably more symbolism involved in the myth than was at first apparent.

At the time I postulated the possibility of a level of symbolism which referred to the creation of a sacred *ranga* (ritual object). This has now been confirmed and as a level of meaning is outlined in Figures 3.7 and 3.8. Included in the levels of meaning that have now been proposed to me are the following outlined in the set of diagrams in Figures 3.4 to 3.6:

- a. the physical life stages of a man (Figure 3.5),
- b. the life stages of a woman (Figure 3.6),
- c. the stages of the creation of a *ranga* (Figure 3.7 and 8), and
- d. the stages of a man's journey through life and then through death to the point of entry into Burralku, the home of the dead (Figure 3.9).

In addition to these "levels of meaning", there are as I will show, variations and interpretations possible in an otherwise apparently fixed system. I first take the narrative version of the myth, the more recently revealed meanings of the analogue, and an expanded version of the structure of the symbolic meanings to demonstrate some of the cosmological assumptions that are implicit in the interpretations.

1.Pre-existence (yothu) Conception	2.Growth in womb (yothu) Own Birth	3.Childhood (yothu) Puberty	4.Manhood (gurrmul) Marriage
5.Married (dirramu) Conception of First	6.Wife Pregnant (dirramu) Child	7. Contemplation (dirramu) Birth of First Child	8.Fulfilment (worrugu) First Child Reaches Puberty Death

Figure 3.5. The physical life cycle of a man.

The narrative version as told by Djorrrpum includes the information associated with the transformation of the rope from one stage to the next, while the contents of the song refer only to the successive states of existence. The song version

commenced with non-verbalised singing which corresponds (in terms of stages) with the assumption that before Mukarr went gathering fibres to make the rope the fibres were already there waiting to be gathered.

In Figure 3.4, it can be seen that the eight sections of the song contents, which represent the eight states through which the rope passes, can be seen as analogues of eight recognised stages of a man's progress through life, or more

1.Pre-existence (yothu) Conception Event	2.Growth in womb ... (yothu) Own Birth	3.Childhood (yothu) Birth	4.womanhood (wirrkul) Puberty Rites. Teaching Ceremony
5.Marriage (wägamirr) First Conception	6.First pregnancy (yothumirr) Birth of Child	7.Mature Woman (guḡman) Child's Puberty	8.
9.Daughter (married) G'child's Conception	10.Daughter (pregnant) (märi'mu or märi) Birth of G'child	11.Grandparent (worrugu)	12. Death

Figure 3.6. The life cycle of a woman.

accurately, the sequence of states of existence he moves through during his lifetime. The additional information supplied by the narrative version includes a series of actions each of which is performed at the end of a stage. These can be interpreted as analogical references to the ritual events which occur in a man's life, the actions performed on the man (the rites of passage), which cause him to be transformed from one religious state to the next. The set of states numbered in the figures as five to eight are also perceived as being in an analogous relation to those numbered one to four. Thus the set of eight static classifications can contract into a doubled set of the four elements which then forms the basis of the analogical reference framework. States 1 and 5 are in a particularly interesting analogous relationship to each other. State 2 is a stage of existence as a child before being manifest as a child

through conception and state 5 is a stage of existence as a married person, the proof of which, and the evidence of which are not manifest until the wife conceives. ¹²

1. Men collect fur or feathers to women	2. Women Spinning basic cord women's work	3. String completed by women handed to	4. String in men's possession. men taken to men's area
5. Construction of shelter Collection of core materials	6. Construction of ranga inside shelter To ceremonial area	7. Rehearsals inside shelter.	8. Final Ceremonials Strings Removed

Figure 3.7. The stages of the creation and life of a ranga.

Each of the Figures 3.4 to 3.8. represents one of the separate interpretations of the symbols in the above myth. Figure 3.5 is an alternative representation of the symbolic interpretation listed in Figure 3.4, but as physical and social man in contrast to the religious stages of man in Figure 3.4. Note that the rites of transfer as shown in this interpretation and the ones that follow may be either socially or ceremonially marked events. ¹³

The Figure 3.6, illustrates the interpretation of the myth in terms of a woman's life cycle. In addition to this it also indicates how the interpretation of analogous reference is able, as it were, to take on a life of its own, such that instead of being interpreted as two layers of four to match the structure of the myth, a third level of four stages was given by Yolŋu people. This third level is interpreted as yet another level of truth contained in the analogue, and was given without any perception that it was going beyond the structural content. It was simply another analogous set. The empty rectangle which represents state 8, I have left empty because it was missed in the discussion. Once the pattern is understood it is not difficult to see that it represents

¹² There is a sense in Yolŋu thought in which marriage is marriage when the couple commence living together, but not completely so until a pregnancy provides evidence of and confirmation of the marriage.

¹³ In these figures, the rectangles represent the separate stages of life, and the vertical lines between them correspond to the events which cause a transfer from one state to its successor.

the post puberty premarried state of the woman's child, and hence a new state of social maturity for the woman.

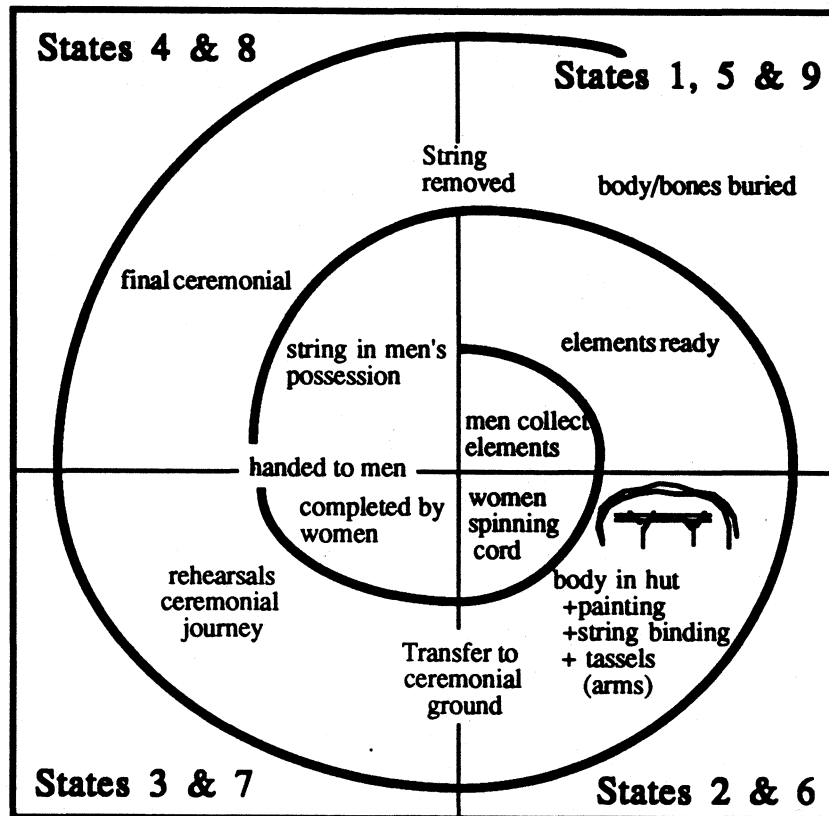

Figure 3.8. Spiral diagram of analogical reference to ranga creation

The interpretation of the myth as representing the construction of a *ranga* (ritual object) is outlined in Figure 3.7 where the basic elements of the interpretation are outlined and again in Figure 3.8, where additional aspects of the symbolism are examined. In order to give a better appreciation of the interpretation, it is of value to consider the normal processes of the construction of a *ranga*, the sequence of events, and the division of labour.

The first part of the production is concerned with the manufacture of the special varieties of string that are needed for construction work. String for ceremonial use is produced from the inner bark of *manuṇyū* (*Ficus virens*) and *gurrumu* (*Ficus*

sp.?) trees. The initial work, from the gathering of the fibres to the production of the raw string is considered to be women's work. As they spin it they roll it onto a core of paper bark ready to hand to the men (with analogies here which relate to the formation of the foetus within the womb and to the birth of a completed child, as in states 2 and 3 of Figures 3.5, 3.6, and 3.7). In the construction they use the decorative elements of fur or feather that have been previously collected by the men (analogous to state 1) and handed to them (analogous to the transfer from state 1 to state 2).¹⁴

The feathered or furred string at this stage is taken over by the men, who store it for use in the construction of the desired ceremonial items, (the state of the string then being analogous to state four in the figures). At this point, the foundational work is finished, as it the women's work, and the men are ready to commence the construction of the *ranġa* itself. After the arrangements have been made for the appropriate ceremonials a shade hut is constructed with supports formed from forked sticks for the *ranġa* to be placed on, and material for the core collected (state 5 in the figure). The *ranġa* itself is constructed inside the hut (as indicated in state 6) and is normally based on a wooden or paperbark core. The hut here being an analogue of the womb. The strings that have been taken from the women are used by the men for wrappings or bindings over the core, and to make *wana* (arms) of feathered or furred tassels using the correct design for the particular *ranġa*. The construction work is carried out only by men of the appropriate ceremonial status and to the accompaniment of the songs associated with the *ranġa*. On completion it rests on the forked stick supports until the time comes for its emergence on the ceremonial ground. It has in the

¹⁴ Women make three different types of string for ceremonial, the type being dependent upon the clan or moiety affiliation of the man for whom they are spinning it. For the Yirritja moiety clans, *bulka* is made from possum's fur or from fibre with possum's fur spun into it. The men hunt the possums, scrape the fur off the skin, and pass it on to the women for spinning. Until relatively recent years, *bulka* was spun from the possum's fur only using the same spindle technique as is used for spinning hair string. Now, because of shortage, the fur is either spun into plant fibre string, or completely replaced by wool in a variety of colours, initially this substitute was extracted from woollen garments, but is now usually purchased in the local store. The Dhuwa clans have two varieties of string into which feathers are spun. One group of clans collects the white down feathers of water birds, splits the feathers down the mid rib thus forming *raman*, and passes on the *raman* for the women to spin into plant fibre. The second group of clans collects the red breast feathers from the rainbow lorrieket. These are spun whole into the plant fibre to produce *worrutj*.

process of construction become a sacred object, a transformation of the represented spiritual entity and is to be handled with great care by the right people.

On the ceremonial ground the *ranga* not only represents the presence of the spiritual entity, it has become the manifestation of that entity, its actions are the actions not of the man bearing it, but of the spiritual beings. The rehearsals are able to be seen as analogous to the later years of life. The removal of the feathered or furred strings from the *ranga*, analogous to the removal of the turtle rope from the float and harpoon barb in the myth is also analogous to the separation of life from its human frame, the string being considered as analogous to the life force of a man, his inner being and desires. The strings then continue in the men's possession while the core is placed inside the earth or water. The deconstruction of the *ranga* being analogous to the end of the physical manifestation of the person, the spiritual being, and the turtle harpoon rope, the final transformation from the physical form at death. Its identity remains embodied in the feathered tassels, and forms an analogue of a man's continuing existence after life in his human body ceases.

1.Pre-existence Conception	2.Growth in Womb Birth	3.Childhood Circumcision	4.Adulthood Death
5.Mokuy, dead but still in body Leaves Body	6.Spirit but still in locality. Indicates presence	7.Crawling and weak Spearing	8.Mature and walking Testing
In Burralku			

Figure 3.9. The stages of a man's journey through life and then through death to Burralku, the home of the dead.

Figure 3.9 shows the stages of a man's journey through life and then through death to the point of entry into Burralku, the home of the dead. This particular interpretation of the myth was a result of discussion with Rurrambu of the earlier analysis. It relates to a brief narrative from his mother, which is included in the later

section of this chapter associated with the journey to the place of life after death.

Whether this was a traditional interpretation of the myth or a story to which he applied the structures of the analogue, I am not able to say, but if it is the latter, it would illustrate the potential for personal interpretation that lies in the structures.

If the interpretation of the myth as the creation of a *ranga* is represented in a spiral diagram (see Figure 3.8), additional aspects of analogical interpretations become apparent. Each of the quadrants relates to one of the four states that are under discussion. In the lower right quadrant (states 2 and 6), the female /processing /commencement principle is dominant. In the myth this is indicated first by the forked stick, and the connection of the elements to it, then by the canoe, and the turtle in it as an analogue of the conceived child within the womb as the foetus forms. This is clearly reflected in the two levels of interpretation, one as the man's life cycle, and the other as the woman's. In the cycle of the *ranga*, it is represented by the women being given the task of preparing the raw materials and turning them into a composite product. In the outer section of the spiral this is analogous to both the hut as a symbol of the womb, and the forked sticks upon which the *ranga* rests, as the woman's body. It is here, within the "womb" that the *ranga* grows from a combination of elements into an entity with body and arms and frequently other anthropomorphic features.

The upper left quadrant (states 4 and 8) is one in which the male /completion /fulfillment principle is dominant. Here the symbolism of the myth focuses in the first level upon the connection of the rope/string (symbol of life and religious identity) to the physical body (the float) and to the sexual maturity symbol, the spear. Having passed through transformation into this state it is one of completion and of readiness to engage in the full activities of life. For the man this represents the passing through circumcision and entry into ritually recognised masculinity. For the woman also transfer to this section represents the passage of the rites associated with the onset of her menses with the ritual entry into womanhood, and one can postulate

that the "dominance of the male" principal is relevant though it was not overtly stated. For the *ranga* it marks the completed and sacred materials in the men's control. The transfer of the string to the men is a conscious symbolising of the mythical action of men in the myth of the Djan'kawu (creative beings) stealing the sacred items from the two sisters who were originally in control of them (as outlined briefly in Chapter 2).

In the outer section of this fourth quadrant, the same male- completion- fulfillment principle is reflected. In the myth the rope has just been disconnected from the harpoon and float. Having completed the task for which it came into being, it lies at the mercy of wind and tide to unwind its elements and scatter them. For the man and the woman both, this state represents the time when the final mysteries are revealed as death approaches and the man hands on his ritual authority to his chosen successor. It is a state of complete dependence upon other males to carry out the appropriate rites at its completion which will transfer him to the next state. Life is complete, the task of raising children is over, human sexuality is of no relevance. In the symbolism representing the *ranga*, there is similarly a state of completion for at this point, is the final revelation of the *ranga* to the new initiates.

The upper right and lower left quadrants (states 1 and 3 respectively) represent asexual states. Though the two states appear to be under the external dominance of male and female respectively, for the individual subject these remain states of inactivity.

In state 1, in the myth and again in the *ranga* symbolism, there is the clear recognition that the elements to be used are already in existence. However there is a contrast between the two. In the myth, the spirit beings (which are not distinguished in terms of sex), collect all the elements; whereas in the preparation for making the ceremonial string, there is a division of labour. While the women collect the physical substance, that is, the basic-frame work, it is the men who collect the feather and fur the patterns of which represents the identity that is to be woven into it. The symbolism

of State 1, in the male and female life cycles, indicates that the raw elements, the unidentified children are in a state of pre-existence, waiting to announce their presence and identity in ways such as I have already described and to combine in the woman's body to form a foetus. Again it is considered normal for it to be the man who has some experience which can be paralleled to the idea of gathering the identifying (inside) elements, while the woman's part is that of the physical (outside) elements. In state 5 there is as mentioned earlier a similar idea of marriage in existence, but not yet evidenced

The third state, while a state of inactivity, is at all levels a period of growth and preparation for the "real" activity of the fourth state, a preparation for transfer to the men's world. In the myth, and in the construction of the *ranga*, the rope is rope and while it does not change from being that, it is perceived as growing to the correct size, or of going through the process of becoming a more complete expression of its nature. Similarly in the human cycles the child while remaining a child "ripens" to the point of completion of childhood. The rope is seen to be piling up on the ground on the other side of the forked stick in the same way as the string is spun on, and the new born infant comes from between the woman's thighs onto the ground.

At all levels of symbolism and in all quadrants of the diagram lies one of the major foundations of what I have previously called "qualitative thinking" (Rudder 1983). This concerns the nature of equality. In Western thought the dominant consideration in the evaluation of equality is associated with quantitative measurement of any quality.^{15a} However, in qualitative thinking (In Levi-Bruhl's earlier writings, "pre-logical"), that which is analogous is considered to be equivalent. This same notion is the foundation of the structure of symbolic reference which functions through the use of analogue.¹⁵ For the person whose thought is based in qualitative logic, that which

^{15a} Here I refer to the dominant though not the only consideration and to everyday practice in the present Western world.

¹⁵ It is also the basis of the thought behind sorcery and sympathetic magic.

is analogous to something else is "just the same" as it or equivalent to it. For the Yolŋu, for whom this is the normal thought style, the layering of analogous reference, that I have been describing in association with the myth of the turtle harpoon rope, is not a situation of one item being representative of the other, but two sides of one truth being expressed. In a way which connects to the earlier described understandings of the relations between whole and part, each is not a symbol of the other, as considered in western thought, but each is considered as a different manifestation of the other, so that the two are in essence, "just the same".

LIFE AFTER DEATH.

It cannot be assumed that there is a single corporately agreed upon body of knowledge about death and dying held by all the members of any group, although there may be groups of corporately "agreed upon" assumptions. Yolŋu society is no exception to this. I attempted on a number of occasions to find the Yolŋu "corporately held truth about the nature of man", particularly with regard to the understandings of life after death, and the question of what happens after a man dies. At a superficial level, the answers I was given did not appear to present a single understanding of the cosmos or of man's place in it. I was presented with a wide range of answers to questions about life after death and an equally wide range to inquiries about death, dying and funerals and the associated practices. As the concepts involved in these answers were examined and discussed with the Yolŋu a second level of understanding linked to cosmological presuppositions became apparent. In this second level I found a high (though not universal) level of agreement, and I will consider that aspect later.

Some of the answers I was given have already been recorded by others and will not be extensively duplicated here. The procedure I follow here is to examine first the range of information I was given about the after death existence of the individual and then consider some of the practices associated with death and dying

that have been discussed in the literature, and which I have observed at a number of funerals. With these will be linked the interpretations of meanings as shared by a range of people which includes confirmed traditionalists, some committed Christians and some who assume to be both. A distinction between corporately held beliefs, which "everyone knows" and individual or small group beliefs, which "no-one else knows" is relevant here. Throughout this section the concepts discussed earlier in the chapter concerning whole and part, life and living, and transformation are of significant importance.

Where do the dead go?

I have not discovered a myth which can unambiguously be interpreted as depicting the origin of death, however there are myths about death, the afterlife and of journeys from the place of dying to a place of some kind that is reached after death, and death appears to be treated as a normal expectation as part of the passage through life. In practice, death with its associated ceremonial appears to have been elevated to the most important of all rites of passage. The certainty of the existence of the afterlife and some details of its nature are verified in the myth of the journey of a man named Yawulŋura to Burralku. Burralku is also spoken of in both the Djaŋ'kawu and the Morning Star myths as being an island to the east of Arnhem Land where the deceased Dhuwa clansmen are involved in dancing every night. Versions of the Yawulŋura myth have been recorded by Warner (1958: 524-528), Thornell (1986:62) Berndt and Berndt (1988:378) and myself (see Appendix B). The myth tells how the man (who has several names) made a canoe journey to Burralku, met the spirits of the deceased, returned to his family and then died and went back to Burralku. The version of the myth recorded in the appendix was told to me by Mathaman Marika at Yirrkala in 1967.

When Mathamán's story is compared with other published versions certain facts concerning the afterlife are seen to be presented.

- a. The Dhuwa moiety dead go to an island to the East.
- b. It is to a place called Burralku.
- c. It is a place like 'here'.
- d. The normal Yolŋu activities are carried out there. A man hunts the same animals and enjoys copulation, singing and dancing. Woman apparently carries out all her normal roles, except that neither in this story nor in any other have I heard reference to childbearing at Burralku.¹⁶

As far as a Yirritja moiety land of the dead is concerned, Morphy (1984:41) gives the name Milnguya [Milŋuya] recording that

In the case of Milnguya the souls go to a place where a length of possum fur string stretches up to the sky. The souls climb up the string until they reach the Milky Way, where the spirits can be seen as shining stars¹⁷

From his description, this place is at least relevant to the Maŋgalili clan whose land is centred on Djarrakpi. The Warramiri clan from Dholtji, further to the north (also Yirritja), speak of a place called Bātu (somewhere near Thursday Island) presumably reached by canoe. I was told about it by a Christian woman who contrasted it with Burralku, saying that,

Burralku is the place for Dhuwa, and Bātu is the place for Yirritja. At Burralku food is *galun* (a yam) and at Bātu the food is *berratha / lanydjarrŋa* (rice). We don't know where it is but we know that when we die that *birrimbirr* goes there. Not married there, just go there and eat *ŋatha* (vegetable food).

These stories give the suggestion that there are conflicting models of the place of the afterlife, however Morphy (1984:41) suggests that,

models Yolngu have are not alternative models, but complementary ones, and they combine with individual theories and speculations on the nature of an afterlife. They provide guidance for individual introspection on the nature of death, and provide focal images that structure collective action aimed at ensuring that the spiritual component of man should reach its destination, or achieve its final state, whatever that state should be.

And again (p40-1)

¹⁶ There are however unresolved issues in the story. This is the place for Dhuwa moiety dead, therefore by implication the Yirritja dead must go somewhere else, so there must be another place for them. Secondly, as this is the place for Dhuwa moiety dead, and intra-moiety sex is forbidden, there is an implication that normal rules of sexual behaviour do not apply.

¹⁷ In this case Morphy is using "soul" to translate the Yolŋu word, "Birrimbirr".

the Yolngu do not have a simple concept of the soul, nor do they have a single model of what happens to the spiritual component of people after their death. Rather a series of models exist which reflect different possible states of spiritual existence which are related to different forces in the universe and different emotions felt by the bereaved. Some models include fairly concrete images of a life after death that resemble closely life on earth.

A Yolngu man is quoted by Morphy as arguing that the Yolngu have "two main theories of what happens to the spirit, one of which is influenced by Christianity". There definitely has been a real influence from Christianity, but the Yolngu have more than two different theories or models. I have discovered several different traditional models as well as a Christian one and I will consider them one at a time.

First there is the "place of the dead" model outlined above with its minimum of three different ideas of location. Complementary to this is the model that proposes that the dead go to the homeland centre (Yirralka) to which their clan is linked. It is this model to which the current funeral ceremonies seem to be most closely related.¹⁸ Each clan has its own Yirralka and some have more than one, so that this model for the place of the deceased has as many destinations as there are Homeland Centres in Arnhem Land.

A slightly different model has the deceased going back to join the clan's sacred identity (the *maḍayin*) and a distinction was made between this identity and the homeland centre where the sacred identity is perceived to exist. As one man said, "When I die I go back to the *maḍayin*." I asked him if this meant the *maḍayin* place (the Yirralka) but his emphatic reply was, "No, the *maḍayin* itself". Warner (1958:25) incorporates these two as a single destination which he names, "the sacred narra well". In terms of geographic location there would appear to be good grounds for this as the

¹⁸ Morphy describes in detail one funeral based on this model, showing how the function of the funeral is to guide the person's *birrimbirr* on its journey to "its spiritual resting place in the clan land of the deceased" (p.47).

madayin is considered to be within the Yirralka. However as the Yolŋu man interpreted this there is a definite difference made between the two.

The series of Yolŋu models that Morphy refers to are not however limited to the notions of a set of places for the dead. These places to which the dead travel form one type of model. In addition to these ideas there is another fairly commonly held notion which overlaps with thoughts expressed about the way a child announces its coming prior to conception. In this set of ideas the no longer physical person can become united at least temporarily with an animal or even a plant and cause a change in it which is recognisable. Nevertheless the pragmatic side of the Yolŋu approach is also likely to come to the fore and the animal will be also recognised as edible though different as Galpagalpa said,

Old time when Yolŋu *dhingam* [person dies], (*miriŋu* [enemy] kill him) *nhanŋu birrimbirr garrtjamballil* (his spirit enters a kangaroo).

Nayi dhu [It will become] *malŋutj* (kangaroo with yolŋu *mali* [image / reflection / shadow] in it) *malŋ'marama* (find) *malŋutjthu.*

"Sometimes Yolŋu will ask "*Garrtjambal yuwalk? ŋula nhä?*" [Is this really kangaroo or what?] *Malŋutj* is very fat and tastes different, like Yolŋu *ŋanak* [Human flesh]. Him *garrtjambal* [kangaroo] all right but taste different."

Or it may be as Yotjin described,

I heard a story that if a Yolŋu dies, he transforms into something like a buffalo. Maybe he comes close to people because he is a transformation of a deceased relative and they feed it and let it go. The spirit goes into the animal and leads him where to go, makes him *bodiny* (peaceful / quiet) and leads him where his relation is. It is normally a dangerous *warrakan* (animal). *Nuli mari djäma marŋgi ŋunhi* ordinary *warrakan*. (If it makes trouble, you know its just an ordinary animal).

In both the above explanations there is the idea that in some way, the person after death, either enters an animal and this brings about a recognisable change in it, or transforms into an animal. In Galpagalpa's example the difference appears to be identified in the flesh of the animal after it has been killed. In Yotjin's story a transformation is perceived in the personality of the animal. This latter type appears to be the more common, and I have been told of kangaroos, wallabies and emus that

have come right into a camp and accepted food from people's hands, showing none of the normal fear of humans.

An animal exhibiting such changed behaviour can be considered to be a deceased person trying to communicate a message and the change in behaviour can lead to a wide variety of interpretations. For example the interpretations could range from good news such as, "Fred's brother has come to let us know that he is happy", if Fred's brother has recently died, to such possibly bad news as "This might be my uncle come to let us know that an enemy has speared him".

A third different kind of model spoken of occasionally is that after a person has died he leaves his body and stays in the vicinity.¹⁹ This links to the idea mentioned above of the need, after a death, to guide the deceased person to their homeland centre. There appears to be a relationship between this and mourning behaviour in that the Yolŋu are all aware that they don't treat everyone as that person would like. As a result, when a death occurs there is the need to express remorse adequate to appease the deceased and their clan, and the need to perform all the rituals for them adequately. There is also the possibility that if this is not achieved, the deceased may stay around and work out their revenge. There is a practice carried out by some, of calling out to the disembodied person after a death, to indicate if they are still nearby by hitting on a tree or something in the camp.

A somewhat different model of what happens after death has come out of the influence of Christianity. Different in the sense of a non-traditional location, but analogous to the first two Yolŋu solutions in that it proposes an after death existence

¹⁹ There appears to be a relationship between this idea and the anomalous state of the *mokuy* (dead one/spirit being). There are also possible links to the notions of *mokuy*s as having malevolent characteristics, and these being linked further to ideas of need for more care in dealing with funerals of what could be called more malevolent people.

at a place. This was neatly encapsulated by Rrurrambu in an interview situation as follows;

Rrurrambu. When I die I don't know what my spirit is going to be (that is, the form it will take), but they will have the ceremonial *bungul* (dance) over my dead body, and those totems will be placed on my body or on my box. Everything will be centred on those two creatures. (Whale and dugong).

J.R. What is going to happen to it?

Rrurrambu. There is one way of saying it. [The one just described]. The truth is ..., you want the truth? All I know is that my spirit will be with God. My spirit will shine with the greatness of his glory.

J.R. Where will you be?

Rrurrambu.. I will be with God.

J.R. If you had grown up without Christianity what would your answer be?

Rrurrambu.. I would go back to the sea, because the people claim that's what I am during my lifetime.

J.R. Back to the same place?

Rrurrambu.. Yep. That's the old philosophy without Christianity.

Not all the Yolŋu follow Rrurrambu's clear distinction between the traditional answers and a Christian one. It is in this situation that the significance of the equivalence between analogous relations and between whole and part again becomes apparent. One woman, a member of a strongly traditional Yirritja clan married to a ceremonial leader from a small Dhuwa clan, was asked what would happen to her when she died. Her answer was so exquisite that on a later occasion when it was appropriate I asked her the same question and received the same answer she had been quoted as giving.

One half of me goes to my homeland and one half goes to that island out there [to the east] and the other half of me goes to heaven [indicating the Christian's heaven].

There was no indication in her answer that there was a problem of any kind in it. There is the potential for her answer to be interpreted in such a way as to suggest that she is considering herself to be some sort of composite, but the understanding of equivalence between whole and part, combined with the analogous relation between the three locations causing them to also be considered as equivalent explains this. One periodically hears the comment that the Yirralka (the central focus of a homeland area) is "just the same as" heaven, so there appears to be no difficulty

in assuming that two separate places are different manifestations or understandings of the same place. As for example one of the younger Dhuwa ceremonial leaders said to me that,

Morning Star starts at Burralku. Burralku means like place of birth and heaven and place where someone dies, they go back there.

That is, the name "Burralku" can be considered as equivalent to "the place of the afterlife", or "the place of pre-conception existence", or any such place. Another example comes from Mawunydjil, who, when asked where he would go after death, replied,

I will go to my homeland, Lungutja. There is also a Yirritja wāṇa called Yirralka. That's where the spirit goes. If I look at it as a Christian, Yirralka means heaven.

On his interpretation it is possible to propose that Heaven and Yirralka "are just the same" in a Yolṅu qualitative sense. From this perspective it is possible to consider that multiple places are multiple manifestations of a single reality and that there is no difficulty for the Yolṅu to incorporate changes while maintaining that that which is incorporated is not new. Bos (1988.392,3) has advanced the idea that the Yolṅu follow a proposition that, "All those things which are accepted as true have always been [in existence]. Then it follows that if x is to be accepted as true, then x has always been." and that this proposition accounts for "the readiness with which 'new' phenomena are incorporated into The Dreaming".

I did not find evidence which conflicted with this. It is however my assertion that it is the perception of equivalence in analogues which provides the mechanism for such propositions to function effectively, for the Yolṅu to hold "different" solutions concurrently, and for these to be considered as not different, but "just the same". There is no difficulty in considering several places to be equivalent, or several different parts of a person or object to be equivalent, and if they are equivalent they are "just the same". So while there appear to be a diversity of answers to the

question of "Where do the dead go?", these can be reduced to the following four propositions.

- a. There is an afterlife at a place to which one goes after death.
- b. Christians go to heaven, Yolŋu to Burralku, so Christian Yolŋu go to both.
- c. When the person leaves their body, they may not go straight to that place.
- d Therefore there may be communication between them and the living.

When these propositions are considered together, they can be asserted to be simply different aspects of a single theme and complementary rather than conflicting. Another way of saying this is that all the various interpretations are analogues of each other. Each reflects the presupposition that identity continues after death and as a result each indicates that there is a place where that continuation occurs. Any new truth which can be considered as analogous to them can then be considered as just the same as them and therefore part of or a different revelation of the same known truths.

The Journey to the place of the Life after Death

In addition to the apparently conflicting ideas of the location of the afterlife, there are a range of ideas about the journey to that place. Morphy's (1984) monograph is a carefully outlined analysis of one such journey worked out through the process of funeral arrangements. The Burralku in this narrative is described as being a very long canoe journey in an easterly direction, and also as the place of origin of the morning star. The story has strong similarities both to the earlier quoted story of Yawuljura, and the exposition by Morphy of the function of funeral arrangements.

An entirely different understanding of the passage to Burralku is contained in a brief story told to Rrurrambu by his mother before she died (see earlier Figure 3.9).

After a man dies, he just goes on walking. Then he comes to a place that is hilly. At that place another spirit sees him there and spears him. The spirits spear him in the elbow and the leg. Up until then he had been crawling, but spearing his elbows makes them strong, spearing his legs makes them strong and then he can walk on with them. He is in Burralku.

Here again is Burralku as the destination of the deceased person, but this time it is on land and can be reached on foot. There is no sea and no island. If we ask the question, "What is Burralku?", it would appear to be conceptualised, at minimum, as a place which is the destination of the deceased. It can be described in terms that make it sound like a geographic location, but has other qualities that indicate that it belongs to a place of a different kind. Some versions of the Djaŋ'kawu myth record Burralku as their place of origin, others have the Djaŋ'kawu coming from a place still further east and visiting Burralku on the way to their landing on the eastern coast of Arnhem Land. We are left with the question, "Where is Burralku?"²⁰ The most accurate answer that appears to be possible is one that leaves it open ended in the way that the Yolŋu do and say that Burralku is simply a general term for the place where the Dhuwa dead go, what it means is open for interpretation.

The Nature of the Afterlife.

The two brief versions of the journey to the place of the afterlife, while they contributed no details of life at the place at the end of the journey, did present several different aspects of the afterlife human being. I have deliberately avoided use of the term spirit as being inadequate to equate to the Yolŋu terms. The Yolŋu when speaking in English often use the words spirit and soul alongside Yolŋu terms as I have mentioned earlier, but there is no consistency in the ways different Yolŋu use the English terms. Unfortunately there does not appear to be any consistency either in the translation of the Yolŋu words into English by previous writers. Judging from the

²⁰ There are also a number of places around the Arnhem Land coast that are called Burralku and at least one of these is said to have been visited by the Morning Star in its travels. There may well be no connection between these places and the place to which the dead travel, but the potential to make connections is there.

context of their use of English there is often no way to isolate which Yolŋu words are referred to.

There are three different attributes commonly isolated by terms for the after death human being used in Yolŋu language. Each of these has a range of meaning and each overlaps to a certain extent the domain of meanings of the others. First there is what is referred to as *wuŋuli* or *mali*²¹. This is the common word used for a person's shadow, a photograph, a representational drawing, or picture of any kind.²²

Secondly there is the *mokuy*. Commonly this word (as described in Chapter 2) is used to refer to both a corpse and to a recently dead person, these two aspects of a person being considered as different. In Djiniyini's story of the journey to Burralku (see Appendix E), *mokuy* is the name given to the dead people who inhabit Burralku. It is also the general term used for a whole series of disembodied "spirits" known to live in different locations, usually with clan affiliations and related myths, song cycles and dances. Often they are described as having exaggerated genitalia and abnormal sexual behaviour, and irrespective of whether these latter features are relevant or not, they may be both celebrated and feared.

One of the Christians said that the Christians have changed their understandings here. When asked about the meaning of *mokuy* in relation to dead body and spirit of the dead person he replied that,

The Christian perspective is that people can say that he's not *mokuy* now, he's only a body. Don't call him *mokuy* again, he's just died. His body is there. The Christians believe a man just dies and his spirit leaves. He's not a *mokuy* any mre.

"He dies human and his body is only like ashes (they say ashes to ashes and dust to dust), and his spirit will be like the second life. If we live we belong

²¹ Warner (1958:445) uses a third word for shadow, "warraw" (his warro) which he treats as an alternative for and having the same meaning as birrimbirr.

²² According to one informant it is also the word he would use for the "spirit" of a dog.

to Jesus, and if we die we belong to Jesus. That's Jesus' decision whether we're his or not.

The third term "*birrimbirr*" (or *mirritjal*) appears in general use to be associated with the after-death form of the complete person, with the idea that this includes identity and personality. If we follow the details from Djiniyini's story, the *birrimbirr* also has the same appearance as the individual with the same ritual markings such as a pierced nose and missing teeth.

These are the generally accepted understandings of the three terms as I have encountered them. It would be nice if it was possible to say that these can be accepted with the precision of definitions, but their use is not as consistent as that. As I have suggested above at the edges of their domains of meaning they overlap and at the overlap either term can be used. The attributes being referred to in their use can then only be clearly understood in context. Each one of them is regularly used in the sense that the other is defined and one may be defined in terms of the other. For example, a *mokuy* may be defined as a "*Yätjkurru* (bad) *birrimbirr*". So while there appear to be three separate attributes of the afterlife human with the appearance at times that these are separate entities, and while there are three separate terms used, the meaning of the terms can only be understood clearly in context.

Processing the Dead

There are three extensive accounts of the Yolŋu approach to the processing of the dead, each of which also includes various degrees of the Yolŋu understandings of these activities. Warner (1937/58:417-438) and Thomson (Peterson 1976b:97-108) recorded their observations at the time when the Yolŋu had just begun to live in settled communities along the Arnhem Land coast (1926-29 and 1935-43 respectively), a time when there appears to have been little change in the traditional process. Morphy (1984) and Dunlop (1984) recorded their observations in the mid 1970s, showing that in the intervening period there had been some changes made in the processing techniques. They note adaptations being made in the forms of

processing, transformations of some processes, and the development of new phases of ritual to meet changes in circumstances. As Morphy says (1984:44),

The system is and probably always has been a dynamic one, and new elements continue to be incorporated within ceremonial performances which themselves are adjusting to changing circumstances.

Both Warner and Thomson describe a second major stage of the processing which involved exhumation and cleaning of the bones of the deceased. These were then stored in a container and remained with the family for an unspecified period. Morphy (1984:43) notes that this processing of the bones had not been done recently at Yirrkala, but that a different second ceremony to process the deceased's possessions is now carried out. He suggests that this may be analogous to the cleansing of the bones. Dunlop (1989) suggests that these possessions are in fact symbolically the bones being processed.²³

In the earlier accounts it is also noted (eg Peterson 1976b:99) that a death could involve the abandonment of a camp immediately after primary burial. Morphy records (1984:44) that during his time at Yirrkala a house would be "abandoned for a period of six months or so", and that this would then be followed by a purification ceremony. In the latter part of the eighties, it has become common that a death occurs outside of a house, often in hospital where the seriously ill are often taken, sometimes in a cool open air shade built specially for a dying person's comfort. So there is a sense in these cases in which the house where the person lived is less "polluted" by their death. However even where a death is sudden, unexpected and inside a house it is no longer uncommon at Galiwinku for the rest of the family to remain continually in residence in the house. This may in fact be continued while the body also remains in the house for the period of the ceremonies.²⁴

²³ This retention of and processing of possessions is a continuing practice with the Yolju at Galiwinku, and with the current investments in large or expensive items such as cars, boats, videos, T.V.s and furniture, there is far more to be processed.

²⁴ Thomson notes (Peterson 1976b:99) that the body was interred either the same day or the next day. Currently the body, now regularly sealed in a special plastic bag lying in state in a coffin, may remain in the camp at Elcho for ceremonies that last a week or more, and at Yirrkala where there are

The concentrations of population in the larger centres has led to a corresponding increase in the number of deaths in a single community in any one year.²⁵ With the increase in the length of mortuary rituals there can now be months at a time when, depending on the distribution of deaths throughout the year, there can be a continuous succession of funerals.

This succession of funerals is regularly managed by having bodies held in the morgues at Darwin or Gove until a community is ready to arrange the next funeral. (see also Morphy 1984:45). Aerial transport between towns means that ritual leaders no longer have distance as an excuse for non-attendance and the relatedness between groups at the different centres puts strong pressure on them to attend. As a result they can be expected to attend funerals for any of the important people in adjacent towns and the funerals of all relatives. Thus ritual leaders can sometimes spend months at a time in attendance at a succession of funerals. One of the responses that ritual leaders who are not closest kin have taken to this has been to arrange for their arrival to coincide with the final part of the ceremonies or on the day when the burial is expected to occur. The implication communicated by this practice is that they are very busy and hence important people, and that they have made an interruption to their other activities because of their concern for the deceased and the families involved.

Warner (1958:417-438) describes a series of processes which are applied to the corpse and to those people and things that in various ways are connected to the deceased. For example; affinal and cognatic kin, those who handle the corpse, or its remains, those who are responsible to process it, and the possessions of the deceased. The processes he describes can be listed as follows;

in the camp at Elcho for ceremonies that last a week or more, and at Yirrkala where there are now refrigerated facilities in the camp for the coffin, it may remain in the camp for several weeks of ceremonies.

²⁵ For example Galiwinku has recorded an average of twelve deaths a year for the last fifteen years and ten deaths a year for the preceding fourteen years.

- a. painting the corpse,
- b. burial of the corpse,
- c. directing the deceased to another place,
- d. destruction of, or distribution of the deceased's possessions,
- e. cleansing / purifying those in contact with the deceased,
- f. cleansing / purifying the place of death.

These were then followed at later times by;

- g. the cleansing and care of the bones from the rotting corpse, and
- h. the final disposal of the bones in a hollow log burial pole.²⁶

Morphy (1984:42) notes that prior to European contact the processing could be considered as occurring in three phases, each of which were times of major ceremony. These were primary burial (which included processes "a" to "f" in the above list from Warner), secondary burial (process "g") and final burial (Process "h"). He makes the observation that while these three phases could still be identified at Yirrkala in the 1970s, the emphasis was shifting towards primary burial.

At Galiwinku, primary burial has become the ceremony to which the largest numbers of people are drawn and as noted in the earlier records, the more ritually important the deceased person is, the more groups attend and the more elaborate the rituals. Secondary burial (Morphy's 'rag' ceremony) is not now a major affair, and I know of only one hollow log burial pole erected at Galiwinku in the last ten years.

Each primary burial ceremony is, as Morphy has noted, a unique composition consisting of elements which relate to the clan of the deceased, and to the clans of those other kin attending.²⁷ The function of the ceremonial is still to carry out

²⁶ It can be said that the tools used in the various corpse-treating processes include; song, rhythm, music and dance, fire, water and paint, and sculptures ranging from sculptured earth, through soft sculptures of a wide variety, to decorated wooden objects and hunting weapons.

²⁷ Morphy's (1984:47) summary of the function of the more ritual elements is that the ceremony is concerned with "the journey of the birrimburr soul from the place of death to its spiritual resting place in the clan land of the deceased".

the same processes as listed above as "a" to "f", working a transformation on both the deceased and the community. In doing this "the same" tools used in the past, or equivalent versions of them are used to work the transformations.²⁸

In evaluating the function of the various aspects of the rituals it is important again to remember the equivalence nature of analogues in Yolŋu thought. The song cycles, dances and other ritual objects and forms which present analogues of the journey undertaken by the deceased person are for at least some of the Yolŋu, not simply symbolic of what is believed to be occurring. They by their presentation can be considered to be creating, co-operating with, or presenting what is happening simultaneously to the deceased so that the performers are not just symbolically involved, but actually involved. As the coffin is moved and the songs and dances present the coffin as a boat (or log) transporting the person, this is not simply a symbol, but a sympathetic portrayal of what is actually happening to the deceased as that person is being conveyed along river courses or tidal currents towards their homelandcentre.

In 1988 a 44 year old Wangurri man died in Darwin hospital after a short illness. At Galiwinku there was a brief announcement ceremony where his identity was communicated to the people through the dancing of ritual elements which represented his identity and the calling of ritual names by which he could be identified without speaking his ordinary name. The men then began to sing for him and to prepare for the arrival by plane of a coffin bearing his body. The coffin was a named boat as coffins are considered to be, and the plane carrying it was a transformation of that boat. The coffin was met at the airstrip on the following Monday by members of the deceased's mother's mother's clan with a four wheel drive vehicle. Some of this

²⁸ Common statements given by the Yolŋu concerning the function of funerals refers to such aspects as, "making everyone happy", or "saying goodbye" or "showing the family we care about them". Such statements as these could be summarised as referring to the affirmation of relationships with those bereaved.

escort carried flags on poles three to four metres long. The coffin was danced with the movements of water from the plane to the vehicle which was now a boat to carry the deceased. The escort formed up in front of and behind the vehicle, becoming a boat as they did so, with the flag poles forming the mast as this transformation of the boat carried the man on a journey through the town for one last look at it (Map 3.2). This journey was arranged so that it culminated at his brother's house where both an open shade and an enclosed shade (housing some ceremonial objects) had been built ready to receive him. On arrival, the coffin, still as a boat was floated from the vehicle in the arms of men dancing moving waters which transported the deceased to the open shade where he was allowed to rest for a while on a new mattress with new sheets.

Groups arrived to pay their respects. Men after dancing along the road up to the sanded area between the shades (see Map 3.1) remained silent while the women who had accompanied them wailed loudly and in each group some women attempted to injure their heads with rocks or knives to demonstrate their grief. As one man described it to me, they were attempting to show the deceased person that they really did care, but that they were guilty for not having shown him adequate care, and now they were showing how sorry they really were for their failures towards him.

Later after all the different groups had paid their respects, and at six thirty as sunset was approaching, the water currents were again danced to move the coffin from the open shade to the closed shade (Plate 3.1). This was a restricted place for men only, where the sacred objects would keep him company, till the final journey to church and grave the following Sunday afternoon. I was not privy to the activities inside.

There is an equivalence relation between the closed shade in which the coffin rests, the grave to which it is transported, the decorated church to which the deceased man journeys for a Christian service, the homeland centre at Dhälinybuy to which the deceased is travelling, and the Christian's heaven, each of which appears to be considered as a different transformation of the same reality.

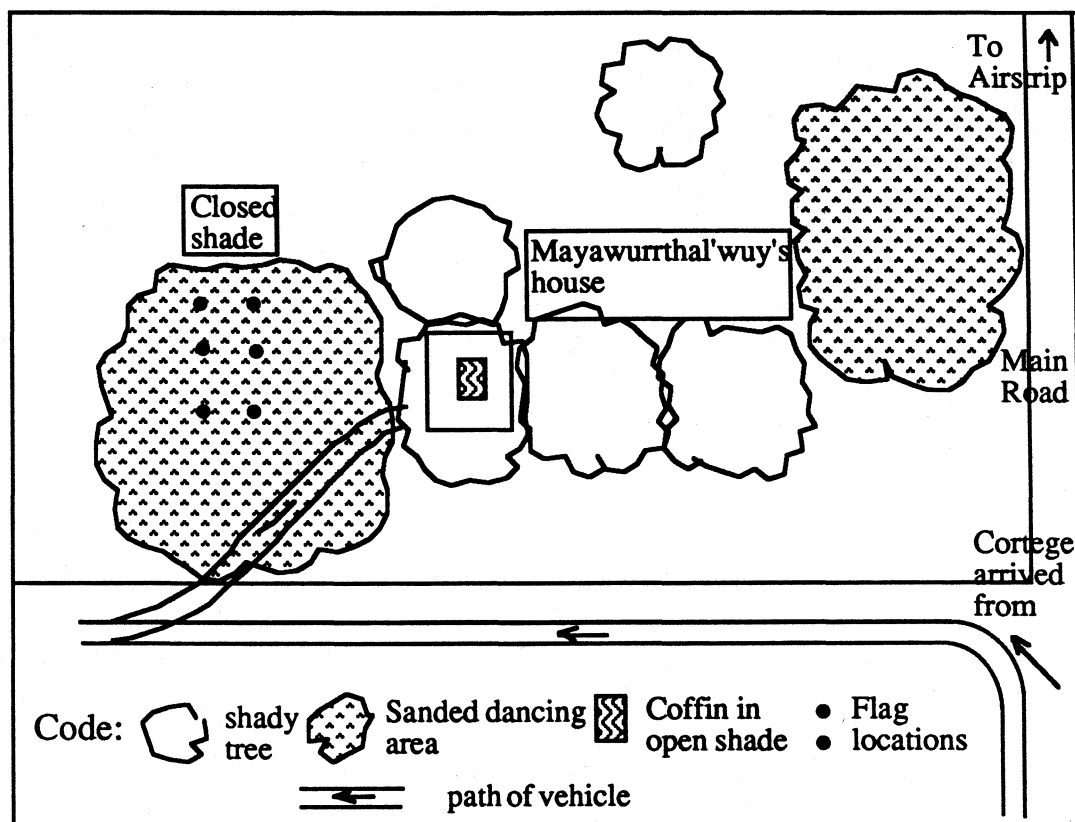

Map 3.1. Wangurri funeral site at Mayawurrthal'wuy's house

On the Sunday afternoon the coffin was transported from home on its final journey. On the way it stopped at the church for a Christian service. The church had been decorated with the dead man's clan symbols in the form of the cycad palm. Four cycad palm trees formed an escort around a bed of cycad branches on which the coffin rested. The "Youth", combined with the "Women's Club" performed a *Biriya bungul* (Prayer ceremony) which was a sung and danced Christian song. One man spoke out the good qualities of the deceased, a brief sermon was preached and then a second dance movement was performed to the Christian song "Take me home Lord". After this the coffin was carried out to the truck for the last stage of the journey to the graveside. At the graveside another brief ceremony was performed which included Christian affirmations that, "Uncle is now in heaven waiting for us. His body is here,

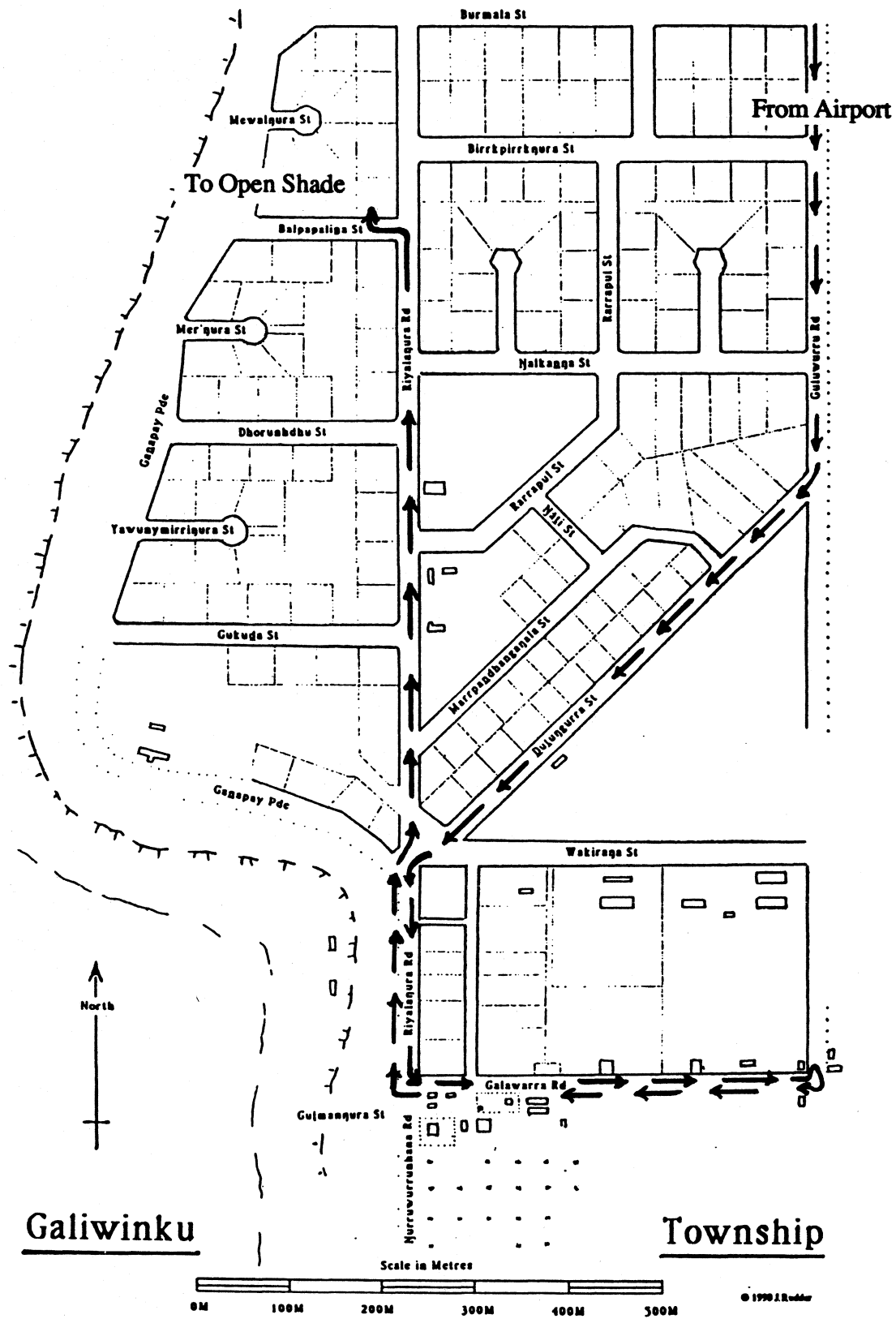

Map 3.2. Journey taken with coffin to enable deceased to have a final look at and say goodbye to the town.

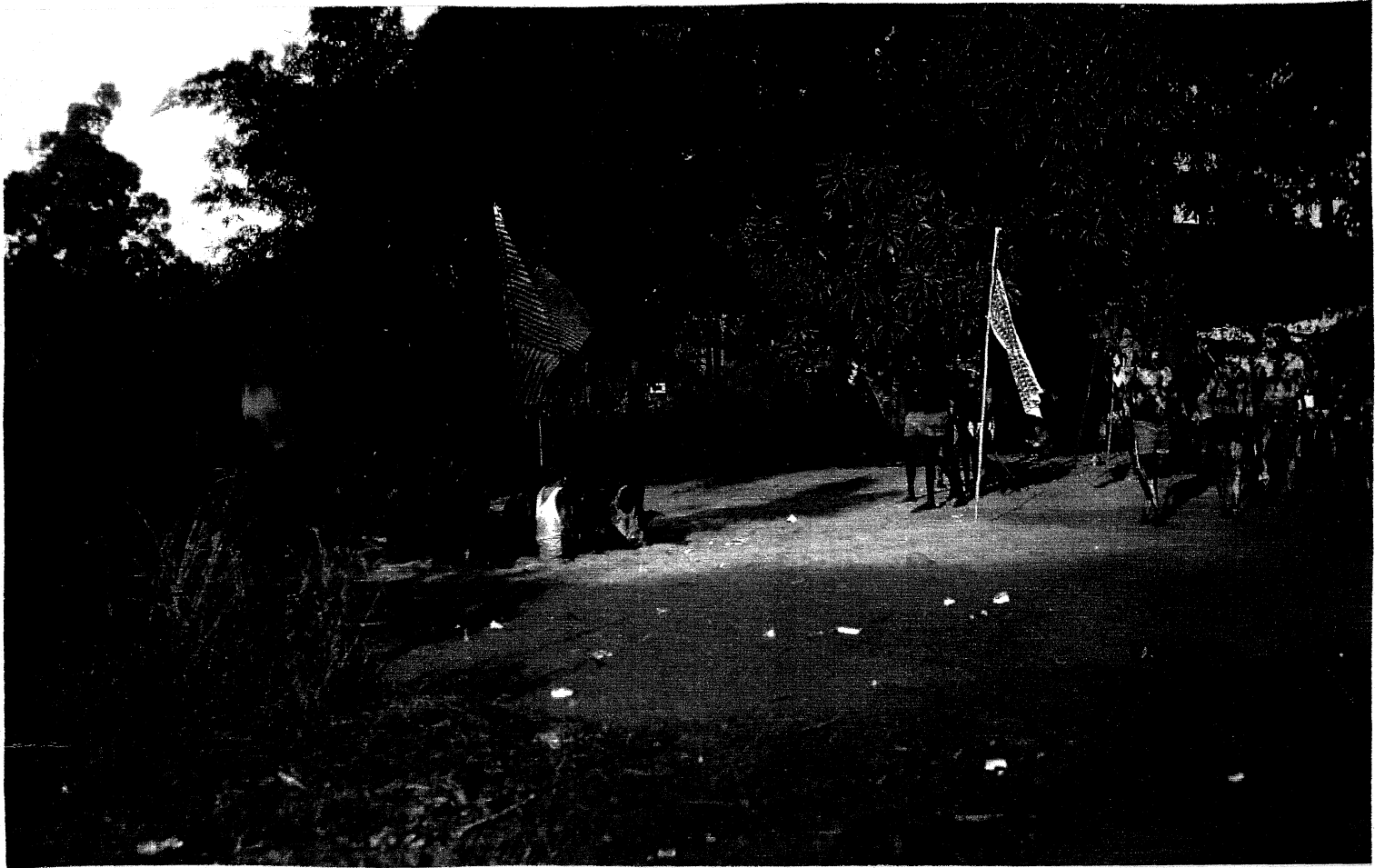

Plate 3.1. Wangurri Funeral Site. Closed shade behind orange cover.

Open shade behind men on the right.

but his spirit is home. Whether we believe it or not there is a home for us." The coffin was lowered into the grave as a Yolŋu traditional leader (*dalkarramirr*) cried the ceremonial invocations (*dalkarra*). A Christian chorus is sung continually and some women begin a traditional mourning wail at the same time as the grave is filled in. When this is completed, bunches of both real and artificial flowers are arranged on the mound. A further traditional song is sung and everyone goes home. It is now after sunset and the dead man has been buried beside his father and his father's brother. There is a spoken intention to put a concrete slab on the grave after the wet season.

CONCLUSION.

The passage through life does not end at death. As has been described, the processing of the dead is a changing ritual (its outside form) but is in the Yolŋu understandings, apart from slight variations in interpretation, able to be considered as unchanging in its intention. That is, the ritual purpose as far as the dead person is concerned is to ensure satisfactory transfer of that individual to the inside place of the afterlife, from the outside. The unchanging, but continually transforming identity has made its final transformation to an afterlife which, while vaguely understood to be a transformation of earthly existence, is not rigidly interpreted.

Discussion of the afterlife and of the journey to the place of life after death has shown that while there is a generally accepted existence of the individual after death, there are a great number of variations of what that means. I have suggested however, that all the various interpretations can be considered as analogues of each other.

As has been shown some of the transformations that the human passes through during a lifetime are celebrated in rites of passage, and in some of these the actual bodies are marked with indication of the particular state achieved. Thus the rites can be considered as marking in both a physical and a ritual sense the successive steps

or transformations towards the fullest expression of the individual's unchanging identity, rather than being thought of as marking changes.²⁹

I have, in the discussion of the turtle rope song, also demonstrated how the perceptions of these transformations can be celebrated in myth and song. It can also be seen that treatment of the analogically perceived layers of interpretation as "just the same" exemplifies the contrast between the Western use of quantitative equality and the Yolŋu use of qualitative equivalence.

In the introduction to this chapter, I described the three Yolŋu notions;

- a. unity between whole and part,
- b. the perceptions and categories of living, and
- c. the ways in which living things are perceived to transform over time.

The relevance of these three conceptualisations to Yolŋu understandings of the human being undergoing the various transformations of life should now be apparent.

When these three notions are combined with the earlier discussed concepts of "inside" and "outside" aspects of existence, it becomes possible to understand the ways in which Yolŋu are able to perceive the human identity as having an unchanging eternal existence irrespective of apparent "outside" changes. This was beautifully illustrated by Rrurrambu in his use of the metamorphosis of the butterfly to illustrate transformation without change. He says that the butterfly does not change what it is, only its outside form, and then observes that its identity is not only the butterfly but that it is simultaneously each of its other transformations.

In these ways the passage through life represents the process of an identity gradually transforming from an almost unformed state to its full expression as it enters it at death; the whole being a justification of the presupposition that identity does not change.

²⁹ The actual body markings such as circumcision, tooth evulsion and cicatrices being permanent, function as visible signs of the transformation that has occurred and the present state of the individual's maturity and ritual status.

CHAPTER 4.

THE PERSONAL COSMOS.

INTRODUCTION : A HUMAN WORLD.

**THE CLOSE WORLD : RELATIONSHIPS WITHIN THE
FAMILY.**

**THE NEAR WORLD : RELATIONS BEYOND THE CLOSE
FAMILY.**

**THE MORE DISTANT WORLD: RELATIONS BETWEEN
CLANS.**

CONCLUSION.

THE PERSONAL COSMOS.

INTRODUCTION : A HUMAN WORLD.

In this chapter I examine some aspects of Yolŋu kinship. Where I do this, it is not intended to be a comprehensive analysis of the kinship system. Rather I attempt to examine those features which enable an understanding of the human cosmos, that network of relationships within which the individual exists. The kin networks are shown to be of major importance to a man or woman in being able to determine or recognise their identity, which is to a large extent understood in terms of the unique place of the individuals within the wider network of relationships.

As soon as I began asking questions concerning Yolŋu perceptions of the cosmos, it became obvious that it was of great importance to the individual to be able to express their identity in terms of these relationships. I asked a number of men and women to draw pictures of their world. Often, though not always, what was drawn was a diagram, not of themselves in a physical world, but of themselves centred in a network of relationships. For example Gapany, one of the Yolŋu school teachers, drew a very quick sketch which I have schematised below in Figure 4.1. In this she paid attention first to those kin whose names are included in the figure and then generalised the larger environment in the terms that I have included in the larger circles, the categories of work-related people being the last additions.

Some time later her husband Maratja, told me about the world he lives in and then drew it for me. In doing so he demonstrated that he also perceived his entire world as composed of people, and people related together in a single great network of relationships. His initial response was,

Me and my family. What's their association links, ties, affiliations, affects me generally. There is order of importance in my family which I normally respect, because what I do affects them directly or indirectly. Then there's what's called the extended family.

He then drew and began to explain the drawing reproduced in Figure 4.2.

In this drawing the centre represents Maratja. The inner circle of circles, he said,

represents the *galkipuy* (close) relations like mother, father, mother's brother, sister, wife, children, sister's children, all those named actual close relations. The extended family is represented by the outer circle. It is the mother's, father's and wives' relations, *wakupulu*, *nāndi'pulu*, *māripulu*, *yapapulu*.¹ Through the extended family we enter into the fabric, the framework of our society. It is this that makes us Yolŋu people unique. Sadly this is being altered by both external and internal influences. The internal pressures come from people not following where society directs. This shakes the society and brings unrest and feeling of unpeace in the community.

When I then asked, "What is external to that world?" his first response was to ask the question. "Is there any?" When I emphasised that that was the question I was asking, he expanded his earlier explanation by adding that,

There are lot of other peoples, lot of tribes, lot of tongues, lot of race, and the pressure that come with that, the adaptability and adaptations. Then there's God. He's everything and like the sustainer who sustains and preserves all things.

During later discussion, he added that, "around the outside of the drawing are the songs and *madayin* that describe the relationship, and they're identifying themselves in terms of the places and the creatures," and then asked the question, "How do *Balanda* (white people) identify *with* the creatures?" There was in his question a clear indication that he was considering identification *with* rather than identification *of* the creatures. It was a clear statement of the focus of the Yolŋu perception of the world, that is, that the cosmos was composed of relationships, and to describe it then required the description of people and things in networks of relationships. "Identification", in the sense that he was using it here, included the notions of identifying with and relating to. The Yolŋu consider themselves to be in an identifiable relationship with all people and all living things as well as being in relationship with the land. These relationships appear to be understood as existing

¹ These terms are explained later in the chapter.

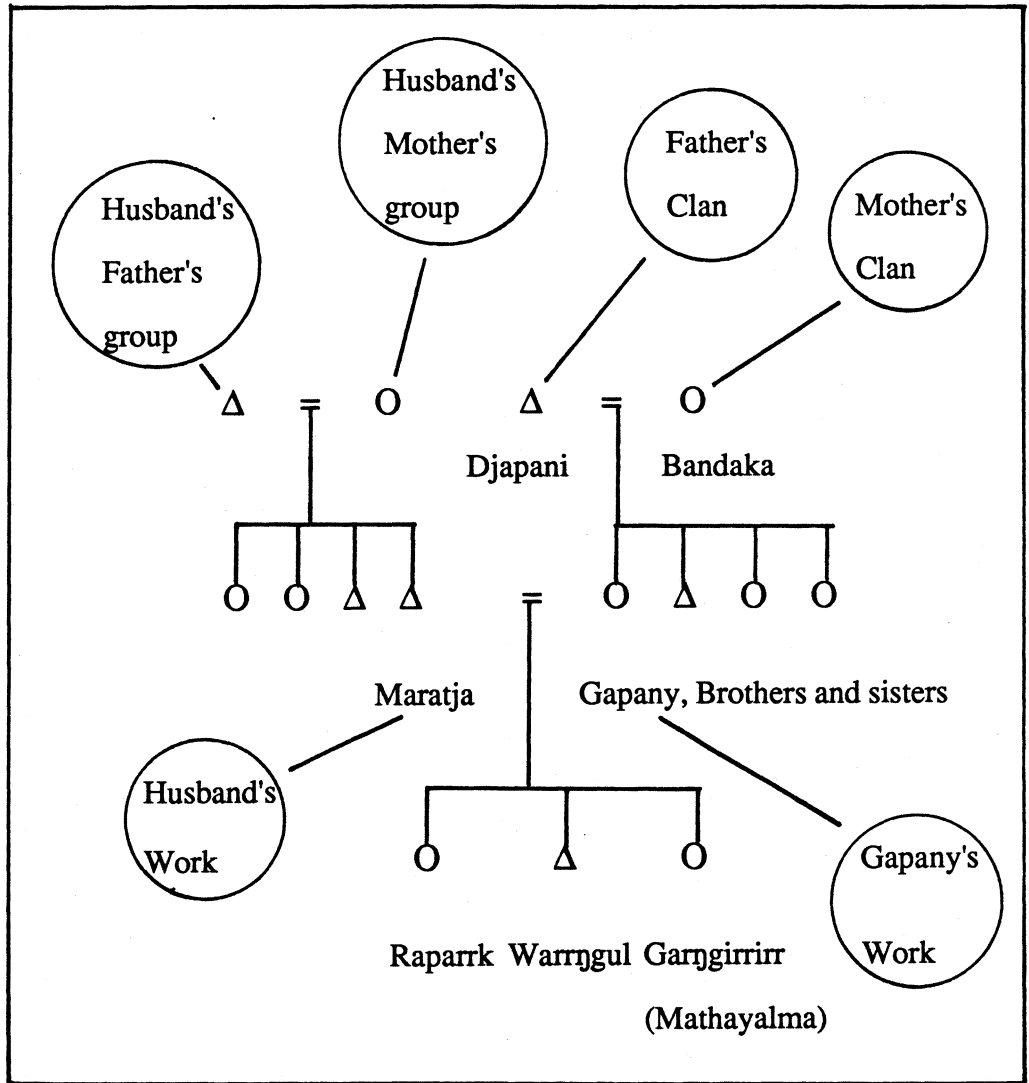

Figure 4.1. Gapany's world.

before birth and, as was shown in the preceding chapter, they also appear to be considered as continuing after death. When looked at from some perspectives these relationships also appear to have an aspect of predestination about them. In the following narrative it is apparent that Maratja sees himself as being in close relationship with plants and animals, sacred objects and clans through his pre-birth experiences and identity as yam.

My mother found *ganguri* (= *gulaka*, [a yam, *Vigna radiata*]) at Dhudupuṅur *ṅunha gali'* (At Dhudupu on the other side) [a place on Gunbirrdji land about four Km north of Galiwin'ku township]. *ṅunhi rraku wāṅa* (That's my place) because I was found there. Mother was camping there with Willy and his wife and other relations, and went out hunting for yams, and they found this one abnormal yam. It was *yindi mirithirr* (big extremely), with lots of shoots and they filled a whole sugar bag with one plant. After that there were a lot of old ladies there and they knew straight away. This is a sign that a new baby is coming, and my mother started to feel giggles and excitement. Then they heard some clapping in the jungle, and after that they went fishing, and everyone caught a lot of fish and were so happy and the old people knew that mother was expecting me, and there was so much food and nearly everyone here had some, and even the missionaries here had a taste of those yams. That *ganguri* had a hairy surface, and the hairs were all cleaned off. People notice that now I have very little hair on my skin and see a similarity.

During the revival there were lots of baptisms, but I didn't get baptised with them then. I was convicted by the Spirit at that time. In 1984 I was baptised. When they said the baptism in 1984 was to be at Dhudupu I felt that to be baptised there was meaningful to me in the sense of that place's association with the announcement of my mother's pregnancy.

These clans have *ganguri / gulaka*; Djambarrpuyṅu - Waṅarr-mānamirr (Djambarrpuyṅu who have *māna* the shark as theirs), Djapu and Gälpu. They all dance it. It is linked to *Bulwunu* (east wind) and to *Banumbirr*. (Morning Star) *Balgurr* (*Brachychiton paradoxis*) also connects to Djambarrpuyṅu - Waṅarr-mānamirr.

Concerning *maḍayin*. (Sacred things) Bul'manydji (shark) is the main one, but sing and dance *ganguri*, though not as much as the other two clans.

My place, Djawal'ṅur / Garrata. *Maḍayin* name Binyambi = Gurala (yindi yäku) Dhadalṅu, Bulku, or Bulkuṅur. Nambatṅu, Gurrṅalṅal, towards secret sacred names.

Maratja means *maranydjalk* (*Gawukalaṅ* or *namal* [names for stingray]). Bulku is a place / bay where there are lots of *gawukalaṅ* and young sharks. It is both a general term for that type of place and a specific name for the shark's site.

In this narrative Maratja describes himself not just as being in relationship with yam, but as if the yam and he are so close that it could be described as being one aspect of him. He also demonstrates a strong feeling of relationship with the site at Dhudupu where his mother found him (as yam) and he affirms this relationship with the place at his Christian baptism.

Through the yam and its associations he sees himself (as a member of his clan) as being in relationship with the members of two other clans both of which share relationships with his own clan because each of them is related to the sacred version of the yam. His thoughts then seem to flow on automatically to other patterns of relationships with these clans through the shark and other significant things. This flow of thought then leads to the major site to which his clan relates, and from the name of one of the smaller sites there to an association or relationship with it through the fact that his own name, Maratja, is the name of one of the stingrays found at that place.²

Maratja was exploring the idea of whether he, as yam, was therefore food for the people, for he is a well educated young man and a bible translator, and was considering whether one of his roles was to be a bible teacher for the Christian community. He was in this exploring the idea of whether God had predestined him in this way, and given the yam to his mother as an indication of his role in the community. He was also seeking to draw together his Yolŋu experience and his Christian experience into a harmonious relationship.³

These examples from Maratja and Gapany, serve to indicate the core of the approach taken by the Yolŋu in the understanding of the cosmos. The world is composed of relationships firstly between close kin, then more distant kin and other peoples, and at the periphery come relationships with the non-human environment which is seen not so much as a set of objects that can be identified but as a set of identities between which relationships exist. It is in this "network" that the Yolŋu exist, and it is in the precise definition of the network of the individual's relationships that his own identity is understood.

² Stingrays and sharks, while separately identified as species, all fall into the one general Yolŋu category of *maranydjalk*.

³ Maratja, in 1990 had a pergola at his front door with a yam plant growing over it and was calling his home "Gäruŋur", which is the name of an important jungle yam site.

Different sections of this chapter will explore the networks of relationships so neatly summarised by Maratja and Gapany, taking them a level at a time, and moving outward from the nuclear family which functions to focus the entire cosmos on the individual. There is no clear boundary which will define those who are *galkipuy* (close) relations from those who are more distant but near, nor is there a distinct boundary between those and more distant Yolŋu people. The distinctions as they occur in the framework of this chapter are arbitrary ones that I have made for the purposes of description. Nevertheless there is a world of closely relating persons which changes relative to an individual over time.

Beyond the close world's network there is a much wider world of *gurrutumirri* (lit. relationship-having)⁴ and beyond that there is the whole Yolŋu community, for all of whom the potential exists for the recognition of named relationships which can be established by tracing relations between actual close kin and intermediate ones. In this way the entire Yolŋu population of some 3-5000 people is able to be seen as being not only potentially, but actually "in relationship", although the particular relationships may not yet have been identified.

THE CLOSE WORLD : RELATIONSHIPS WITHIN THE FAMILY.

The close world is composed of those *galkipuy* (close) relations with whom ego relates on a day to day basis. These as Peterson (1974) and Shapiro (1973) have clearly demonstrated, in discussing aspects of Yolŋu kinship, change over time. They are a much wider group of people than is thought of as immediate kin in Western society. To give some idea of the set of kin who form the network in which

⁴ Shapiro (1981:41) translates this term as "aggregate to which kin terms literally apply" but the meaning is more flexible than this and *gurrutumirri* appears to refer to those kin to whom an actual relationship can be traced through the kinship system. Those included in this category in any particular context of its use will be those that it is relevant or politically expedient to include in that context.

Yolŋu life is embedded at any period of time, I will examine a number of actual household networks.

For any individual person, there is a gradual though continuous transformation in the group of people who make up the close family. This process of change is well documented in anthropological literature (e.g. Goody 1958) and has been discussed by both Peterson and Shapiro in some detail.⁵ The material that I will present here is complementary to rather than in contrast to the evidence they have presented. One thing that stands out about my own observations is that while the geographic situation is different from that discussed by Peterson, and the town has changed considerably since the period discussed by Shapiro, yet there are underlying principles of social action which have remained consistent. One factor in the present town situation which was not so intrusive in the earlier situations is the development of improved housing. Living in houses places certain restrictions on the size of households, so too does a shortage of housing. With fifteen to a house being common and some households having more than twenty members in a two or three bedroom house, the pressure for space can be intense.

The individual Yolŋu is born into an already existing domestic arrangement which goes through a series of changes as time passes, each person experiences growing older and the individuals undergo the gradual process of moving through the different levels of social and/or religious categories.⁶ Fortes (1958:3) discussing the developmental cycle of domestic groups suggests that, "Residential patterns are the crystallization, at a given time, of the development process".

⁵ Peterson made his observations in the small geographically separated communities on the mainland which are presently referred to either as homeland centres or as outstations. Shapiro's study of these transformations was in the town of Galiwin'ku itself in the mid 1960s when the town was simply called Elcho Island.

⁶ As discussed more fully in the previous chapter.

Assuming this to be so it is valid to consider that the transformations of the individual's domestic situation can be generalised as following particular changes in the patterns of living arrangements. These were identified at Elcho by the simple process of observing who lives with whom. In this section I demonstrate the process of change by examining the composition of relationships in a series of households. These illustrate the types of changes that occur as the family of an individual divides, expands and redivides.

Prior to marriage, most young people remain in the same house as their mother, father, brothers and sisters. This however is somewhat wider in connotation than the understanding of modern, nuclear family oriented Western society. Mother's sisters are also called and related to as mother, and father's brothers are called and related to in the same way as father. Similarly all of mother's sister's children and father's brother's children are called brother and sister, so that at any time a child may be domiciled within any of a wide range of households though there appears to be a general tendency for this to be oriented more toward the female parent's kin than the male's. That is, if a child is not living in the home of its parents, it will probably be living with an older sister, a mother's sister, a mother's mother, or a mother's mother's sister. This focus on but not exclusive use of matrilineal arrangements for children becomes apparent when the kinship patterns for various households are examined⁷.

After marriage it appears to be the common practice for a young man to move into the home / household of his new wife's mother and father to live with her⁸. At some stage after they have begun to raise a family of their own, and apparently depending largely on the availability of housing in the community, a young couple will become the focus, or nucleus of a household of their own.

⁷ Shapiro in his studies apparently ignored the location of children

⁸ As noted by Peterson.

In the two cases where I recorded what could be called nuclear family households, the young couples had each moved out of the girl's home into a nearby disused house that was of a poorer quality than the one they had left; one that was not wanted by anyone else. One of these couples, a sister of Maratja and her husband, already had two very lively children and in their separate residence they were almost permanently hosts for different members of the husband's family as they visited from the neighbouring town of Yirrkala. The house they left had eleven residents and the new house was about a hundred metres from her parent's house. The other couple moved into a semi-derelict house opposite the wife's widowed mother's house to establish their own home. While they then occupied separate houses it was in practice still functioning as one household in that they still spent most of the day together and still appeared to be eating together. This young couple had five children of their own and there were thirteen people in her mother, Muḡunayḡu's house including two married sons with their wives and children. The relationships between the residents of these last two houses are shown in Figure 4.3.

Maratja's family, discussed earlier, while a nuclear family, does not equate with the Western concept of a nuclear family. He and his wife are a young couple from two prestigious families with their own home, a house of intermediate quality. In their household at the time I visited, there lived Maratja and Gapany and their three children, Raparrk, Mathayalma and Warrḡgul. With them lived Maratja's sister Mirrinybal, a single parent with her two children Ganyul and Bandawuy, and two children of Gapany's sister (Nḡandama), Wan'kal and Djaymila. It is worth noting that while the details are not exactly the same as the focus of Gapany's world as discussed earlier, yet the members of the household fit within that focus being either brothers, sisters or their children. (See the contrasts between Figures 4.1. and 4.4.).

By the time a new family has become independently housed, it appears normal that, as in Maratja and Gapany's case, there will be other kin living with them.

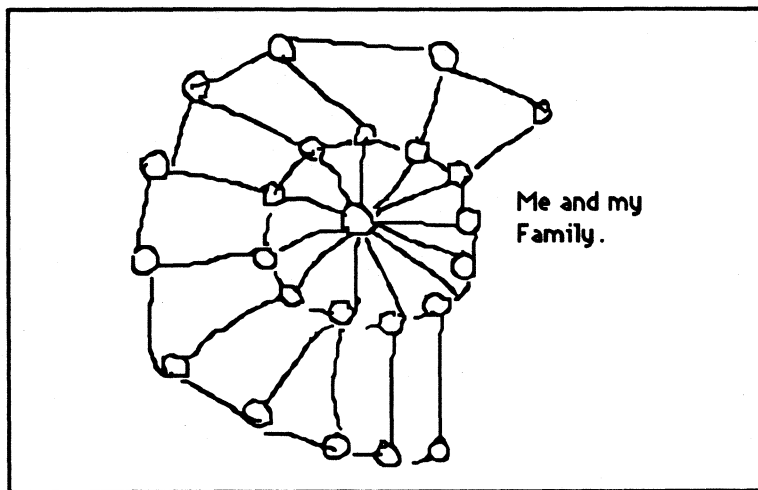

Figure 4.2. Me and My Family. (After Maratja).

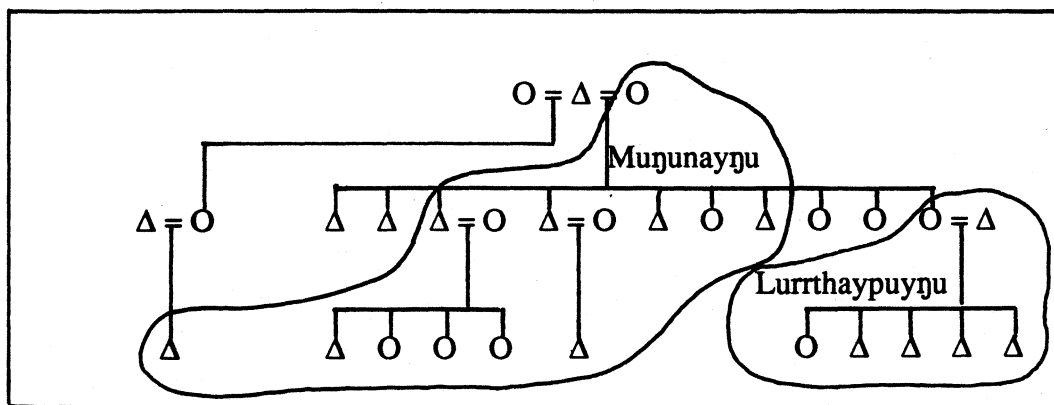

Figure 4.3. Members of Muṇunayṇu's and Lurrthaypuyṇu's households

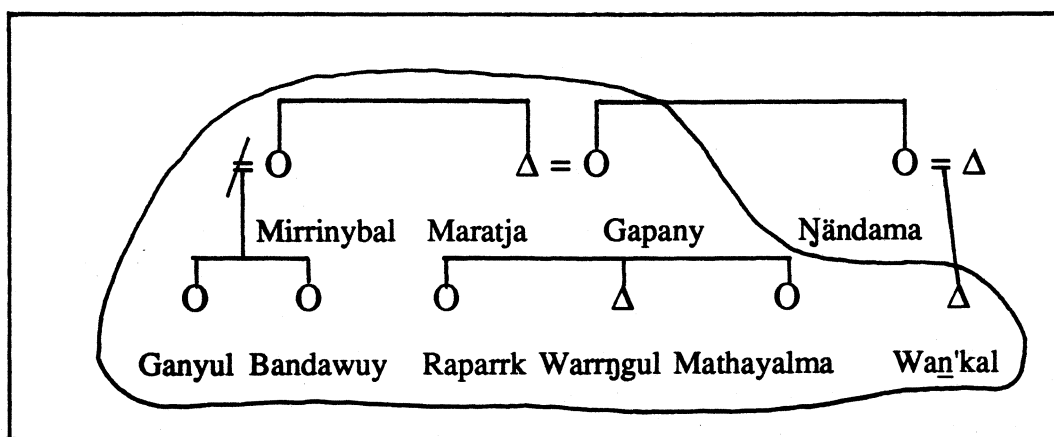

Figure 4.4. Maratja and Gapany's Household. (July 1990)

In a relatively brief time the eldest daughter will be the focus of a new marriage, and the cause of a new male becoming part of the household. In this way, the new household continues to expand. I did not have the opportunity to discuss in any detail the ways in which young polygynous households develop but it appears possible that this can happen in at least two different ways. It is possible that a man may stay in his wife's parental household until he has acquired one of her sisters as wife, though I collected no examples of this happening. What I have observed in several cases is that a man in a separately established household will bring a second and younger wife into it. In one case a middle aged man left his established household at Elcho to go to Yirrkala to live while he established a married relationship with a young promised wife from there. He had not returned to Elcho by the time I left, and I do not know whether he has brought the new wife back to his old home or whether he has stayed with her.

When the children start to marry, the household begins to change in a variety of ways, with at first the increase due to incoming daughters' husbands and the arrival of grandchildren. I examined in detail a number of these households, finding the patterns of movement of people and the changes in households to follow fairly consistent patterns.

Maratja's father was monogamous. In late 1990 he had become very ill with cancer of the mouth. The daughter who had been living with Maratja moved back into the home to help her mother and the other sisters to care for him. Three days before he died in April 1991 the distribution of his children and the members of his household were as shown in Figure 4.5. As a result of his death this household will undergo more changes in membership, but will probably, like the majority of households yet to be discussed, have an older woman as their focus.

Rarrkminy, already a widow for many years, has around her, and living in the house with her two married daughters with their families plus several other

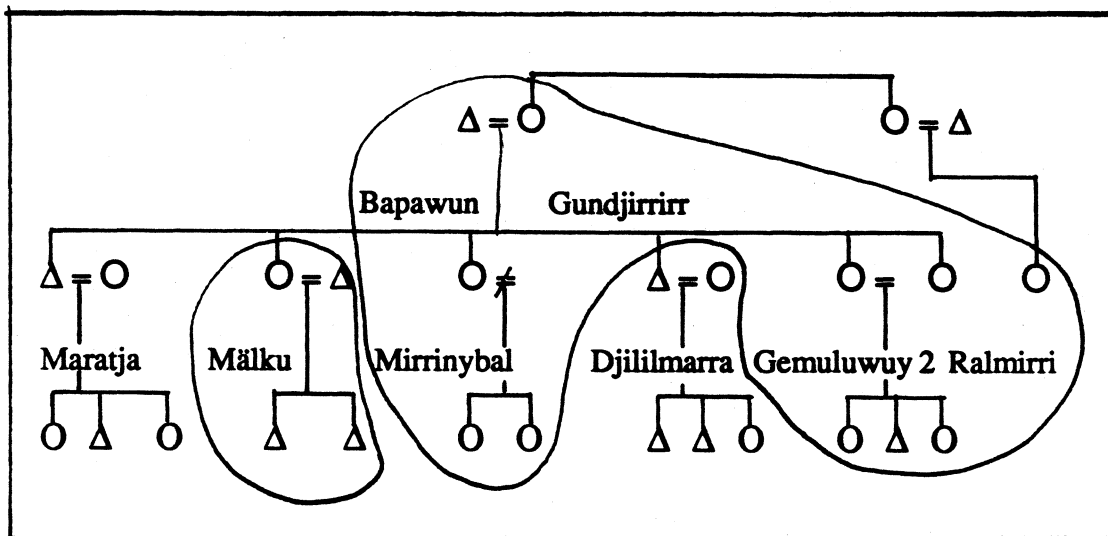

Figure 4.5. Bapawun' and Gundjirrir's Family and Household (April 1991)

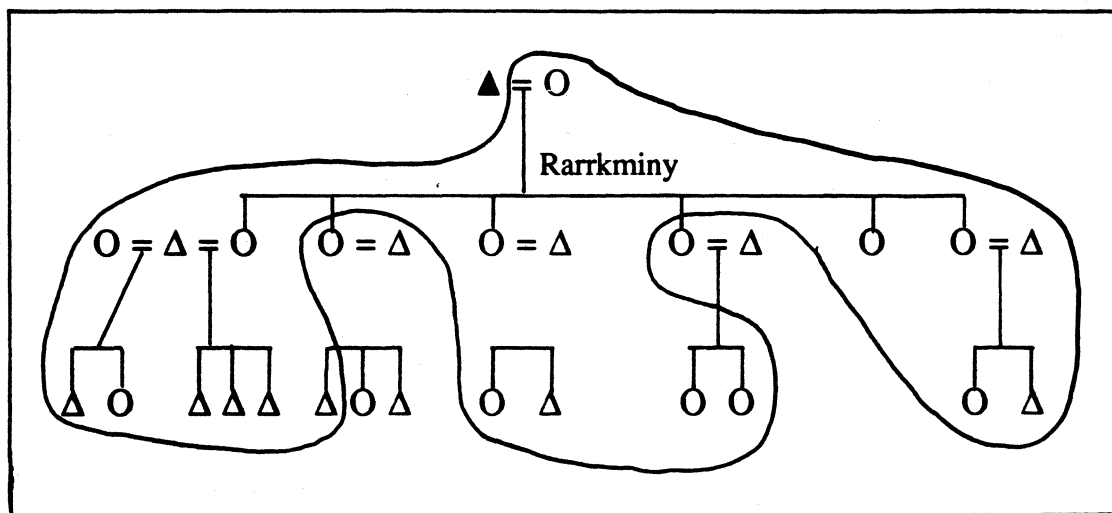

Figure 4.6. Rarrkminy's Household (July 1990).

grandchildren. The grandchildren are the children of three daughter's who are currently living in Darwin. This household, typical of the matriarchal stage of transformation is illustrated in Figure 4.6. Each married daughter living at home has a separate room for her family. At times when the remaining Darwin based families are home, her daughters are likely to stay with her and the daughter's husband to stay with the members of their own childhood households. Households where the husband was polgamous follow this same pattern except that when the husband dies, if the wives do not remarry, each tends to become the nucleus of a separate household.

On the basis of the structures represented by these households, it is possible to draw some simple conclusions about the changing cosmos of the individual man and woman.⁹ One thing which does appear from my own data, is that each household appears to have within it a focal individual or a focal married couple. This is not able to be compared adequately with either Peterson's or Shapiro's data. Peterson however does indicate that there are what he calls "core" members of the band. While he treats the band for the most part as a single unit he refers to separate family groups within that whole and his "core" members have the possibility of being interpreted as what I have termed focal individuals. However the data as presented does not give a clear indication as to whether or not each of these core individuals could be considered as the focus for particular members of the band.

Shapiro's purpose was different from my own and by eliminating all under 14 years, and by combining the residents of separate houses to form what he describes as "households" (using that word in a different sense from me) he makes any close comparison almost impossible.

⁹ Peterson (1974:24) examining such transformations over time in the small bush communities saw them in terms of an oscillation between two models, one of which was the patrilocal group and the other based on the uxori-patrilocal residence of younger married men. In the town situation these two models are still clearly visible although the people are not living on their own estates.

The households that I have examined make it possible to give some indication of the transitions which occur in an individual's close world whether the individual is male or female. A male child grows up in a close family group in a household which will include his mother or one of her sisters, and probably also his father although the father is not essential. At some stage he may move house to live with one of his older, and possibly married brothers. At his first marriage he will in normal circumstances, join the household where his new wife lives and stay there until it is appropriate to move out with his wife and children. At that stage he will most probably become the focus of a new household to which others of his own or his wife's siblings, with or without children, are likely to adhere. For the rest of his life until extreme old age and a renewed dependence on others, he is likely to remain the focus of the household he is in. Men who remain single appear to attach to the household of their father or to one of their older brothers and do not appear to become the focus of any part of the household.

A female child up until marriage will also remain in a household with her mother or mother's sister. Again the father's presence is not essential. At marriage, if she is a first wife, her husband will in most cases move in to live within her childhood home. At some stage she will move to a different household where her husband will probably be the focus. This will last until she is past childbearing. At that point if her husband is still alive she may remain with him, but if he dies or if she is one of a number of wives, she may then become the matriarch of a household which will probably include her children single and married. It appears usual for this to include married daughters, their husbands and children and less common to include married sons. If, in contrast to this, she moves into a son's household, it is probable that the son will share if not assume the focal position in the household.

More frequently now than in the past women are choosing to remain single. While the above outline is the general pattern of household transformation,

there are a number of single mothers, who, while acknowledging the father(s) of their child(ren) may choose to live without a male and will usually reside in the home of one of their parents or that of another sister. Very occasionally a single mother will live in a brother's household.

THE NEAR WORLD : RELATIONS BEYOND THE CLOSE FAMILY.

Beyond the close world are those relations who are collectively known by the term *gurrutu'mirriju* (relations).¹⁰ There is a complex set of kin terms applied to these relations, and the discussion of these terms together with the relationships they represent form a comprehensive literature. (Warner, Webb, Shapiro, Morphy and Keen and many others). The hypothetical system for the terminology is shown in Figure 4.7. Whereas most descriptions of the terms go no further than five generations on the basis that the central ones make up the full system, I have, following observations of the references used by different Yolŋu, chosen to extend it two further generations in both ascent and descent from ego to peripheral kin and those forebears and descendants not likely to be living at the same time as a person who may refer to them. It is not until this is done that some of the conceptual framework behind the system appears clearly. Irrespective of whether ego is male or female, the terms shown are the one that ego uses in reference to the person occupying the particular relationship position shown.

Warner (1937/58:59) represented the Yolŋu kin terms as covering seven patriline linked by marriage. Shapiro (1981:38) apportions these same kin terms to what he calls "seven kinds of social unit", but then lists these seven kinds as each

¹⁰ See Footnote 3.

being a separate sib (his term for a locality oriented patrilineal group) so in practice has represented seven patrilineal lines the same as Warner, in spite of some small differences in detail and in the choice of dialect from which the terms are recorded.

I was interested to discover just how far the Yolŋu were prepared to extend the terminology, and discovered this to be a mental exercise that they really enjoyed. It was not difficult for them to take terms beyond the nine intermarrying lineages which make up the core of Figure 4.10. I have chosen not to go further than the limits of the present figure, because it is at nine generations and nine lineages that some of the most interesting features of the relationship system become clear.¹¹

In the figure, I have marked the terms which are repeated in both patrilineal and matrilineal descent lines, and it can be seen in these sets of terms that if one takes ego as the focus and moves back to the fourth generation a term is reached that is the same as the term used for ego's child in that line or to the fifth generation to one that is the same as ego. Similarly if one moves down to the fourth generation a term is reached that is the same as the term used for ego's parent in that line and to the fifth to a further repeat of the terms for ego. Counting outward from ego with ego as the first generation the third generations both upward and downward are the ones in which the most important reciprocal ceremonial relationships are found. That is, those relationships between the male individuals labelled *māri*, *wāwa* and *gutharra*. In his world, as generation succeeds generation, a man moves from the lowest of the three terms in generation and ceremonial importance to the highest.¹²

The relationship between these three matrilineally related men (*māri*, *wāwa* and *gutharra*) is one of the most critical and one of the most interesting in the whole

¹¹ To record the terms as I have done gives the impression that the particular relationships shown in the Figure will inevitably be labelled by the terms shown. This is not so. Towards the periphery of the chart the terms used may vary according to the path taken through the relationship network to the position labelled.

¹² If he lives to see his great grand child he has moved to a position which can best be described as beyond the point where he is necessary to the religious system.

relationship system. If the person called *māri* by ego and the person called *gutharra* by ego refer to each other by kinship terms, each calls the other *wāwa* (brother). Each also calls the sister of the other by the term for sister (*yapa*). I became interested in the implications of this repetition and as I was discussing the kinship system with a group of women, I posed the following proposition to them,

"We call *yapa* and old *yapa* by the same name, '*yapa*'. If they have the same name there has to be something the same about them."

The response I received still amazes me. One of Rarrkminy's daughters of burst out immediately with great excitement,

It's the *maḍayin* (sacred elements). They have the same *maḍayin*. It goes back inside through the women.

There is immense implication for understanding the structure of the relationship system in this one outburst. There are three generations between the repeated terms '*yapa*', or for that matter between any of the repeated terms in the central area of direct matrilineal or patrilineal descent between any *yapa/wāwa* sibling pair in the network of terms. Given that alternative patrilineal lines are of the opposite moiety, the *yapa/wāwa* sibling pair and either *māri* or *gutharra* between them in the matriline are all from the same moiety.

First, third and fifth generations, being of the same moiety, share the same sacredness of the one moiety, but it is the central one of the three who carries the sacred knowledge from the first to the fifth generation as it is the first and fifth generations which share their identities through sharing the same sacred objects¹³. When Yurranydjil gave her excited answer it was to this relationship between the first and fifth generations that she was referring. The old *yapa* with her brother share one sacredness. This goes inside (where it is not overtly perceived) through the next three

¹³ See further discussion later in this chapter.

Figure 4.7. Hypothetical system for Yolngu kinship terminology.

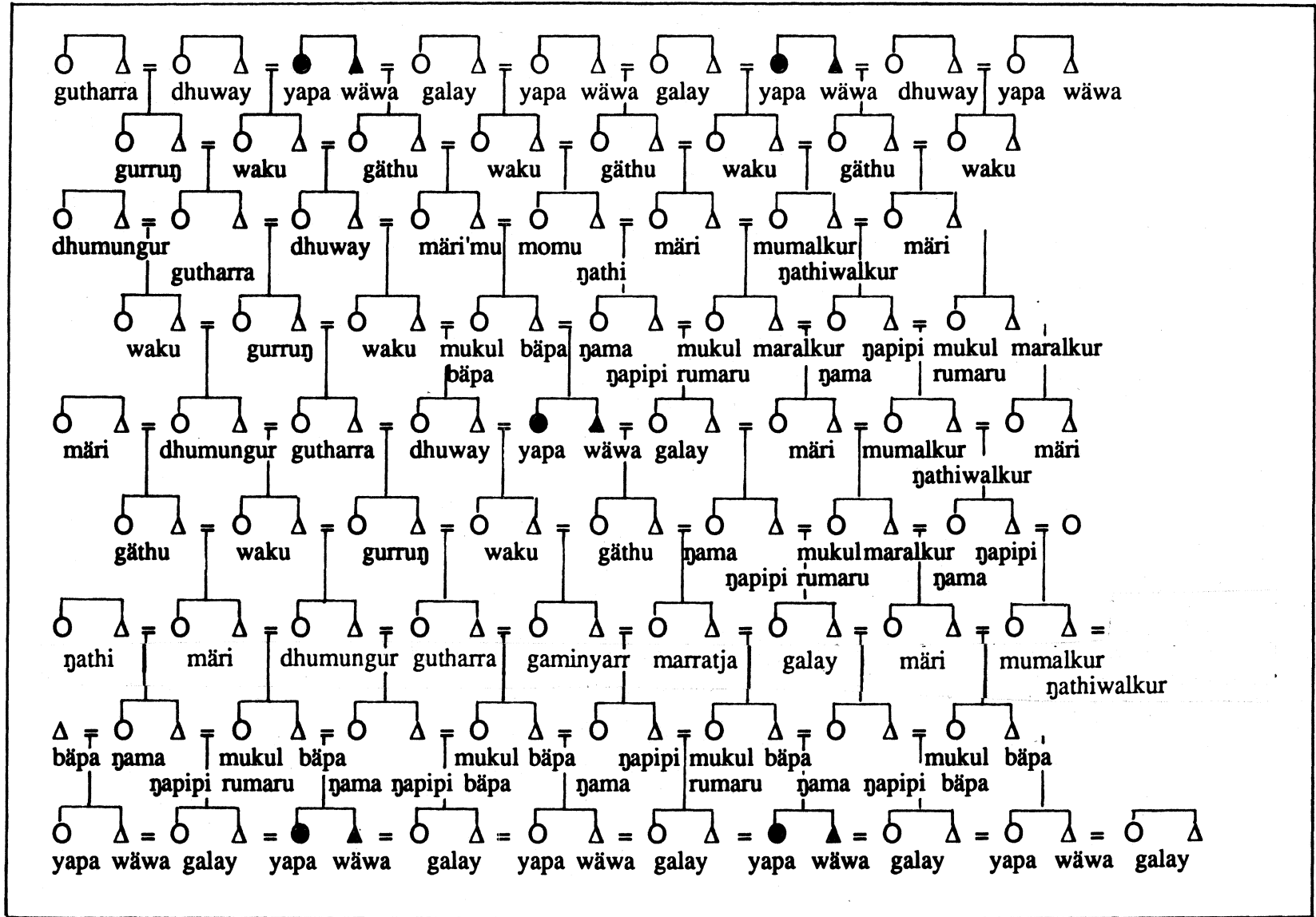

matrilineal generations of women and then comes outside again in the form of the *wäwa/yapa* sibling pair of the fifth generation.

If however instead of thinking of the *maḍayin* as sacred objects, one considers them as being the representations of the elements of the individual's identity, the significance of this transference becomes more apparent. It means that arrangements are so made that by arranging matrilineal transfer in accordance with the hypothetical system, the children who have a pre-existence with a particular clan's identity will be born to women who are in the clan relationship of being mothers to the clan of the pre-existing children. In that way the child inherits its identity from both mother through the matriline and father through the patriline. It is this transfer of sacredness which appears to be one of the most significant purposes behind the bestowal of women. This bestowal of women then functions not as a bestowal of wives as property, but of women to be mothers for children of the right identity and sacredness. These mothers and their clans together with the set of clans in this sequence are alluded to frequently as the *yalu* (nest), an analogue of both the womb and the sacred inner (or unseen) dimension.

Superimposed over the kinship network there has been introduced a further set of classifications generally described as subsection terms. These terms, known collectively as *mälk*, neatly follow the matriline. According to Elcho Yolḷu this has occurred in relatively recent times. One man said to me that,

.....'s grandfather brought the *mälk* here at the same time as he brought the *Gunapipi* (ceremony)

Already operating when Warner was doing his fieldwork in the late 1920s, the *mälk* can most simply be described as two sets of four terms, each with male and female forms which classify the entire Yolḷu population into eight inter-relating categories. As an individual's *mälk* depends on that of his mother and they are inherited matrilineally, alternate generations of a set are of opposite moieties.

Displayed in Figures 4.8 and 4.9, are the positions of the two sets in the relationships that develop as what are called first choice and second choice marriages.

The Ideal Marriage Pattern.

The *galkipuy* (close) family is embedded within the wider kinship network. The pattern by which this is established is related to three things; the movement of women between clans, the relations between groups and sacred objects, and finally the relation between these and particular sites in the landscape. There are both ideal patterns for this movement of women and actual patterns. The ideal patterns are those that I have taken to represent the cosmology expressed in relationships. The actual patterns are often somewhat different. A marriage between two people which follows the traditional system brings into fruition the relationship between groups which has been, in most cases, established long before the two individuals were conceived. In my inquiries as to how a man obtained a wife I asked Rarrkminy, a senior woman from the Djambarrpuyŋu Gundapuy group to explain to me how the marriage system worked. Her response was given in terms of a set of sites which give their daughters as potential mothers for the children of another set of sites.

According to Rarrkminy (making a deliberate simplification to explain the hypothetical system), there are, from the perspective of the Djambarrpuyŋu Gundapuy clan, four sets of sites involved in a circular transfer of daughters. These groupings are represented in the Figure 4.10. Daughters are given from one group of sites to any of the sites in the next set, in the direction of the arrows. It is of great significance that all of the sites in a set share some major sacred object. Thus all the sisters of clansmen in that set carry the same sacredness within them as their brothers. When a woman *gutharra* is given to a male *dhumungur* to bear his children, their daughters will be the *ŋama* (mothers) for a new generation of men and women who manifest the same sacredness as the clan members of the original set of sites. In this way the matriline carries hidden within it, for three generations, the sacredness of the set of

clans and sites, as was described in the earlier quote from Yurranydjil. By following this pattern of bestowal, the continuation of the sacred identity of each site is guaranteed even if the patriline dies out and is replaced by descendants from the matriline. The retention of the sacred identity within the limited group of clans of the set ensures that the control of the spiritual entities and hence also the *ranga* (sacred objects) and sites are retained by a closely affiliated clan. Within this mechanism also lies the foundation for the transference of site responsibility from one clan to another within the members of a set.

One of the sites, a slightly more inland oriented one than the others which are predominantly coastal, as well as being a part of the cyclical pattern, has established a separate mutual exchange relationship with three other sites (also shown in the same figure). Within these alternative distributions lie potential for developing relations with other groups of sites in different sets. I do not wish to follow these links here beyond indicating that they exist and that they also give a further example of the interweaving of the complex networks of relationships across Arnhem Land.

For Rarrkminy the ideal marriage pattern for the group of clans to which she belongs is represented by the passage of daughters from one set of sites to the next set of sites. The contributing group of sites is seen as in the relationship of *ṅāndi* (mother) to the receiving set which is in the reciprocal relationship of *waku* (sister's child). Each of the sites in the receiving set is thus seen to be in the relationship of *waku* to *ṅāndi* to the site from which the bearers of their children come. They are the "bearers of the clan's children" in two separate senses. They bear physical children, but they also are bearers of the spiritual identity of those children as well. The set of terms used to name the relationships are the same set of terms just discussed which classify the relationships between the women in ego's matriline.

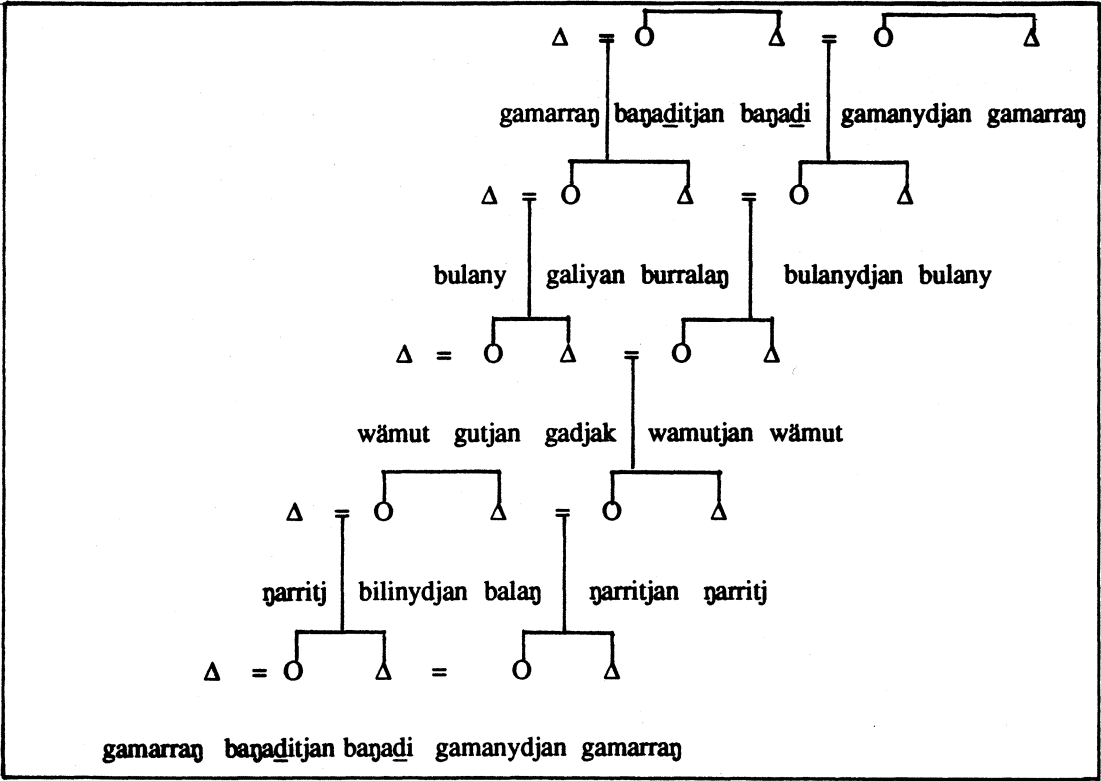

Figure 4.8. First Choice set of Marriages relationships according to *mälk*.

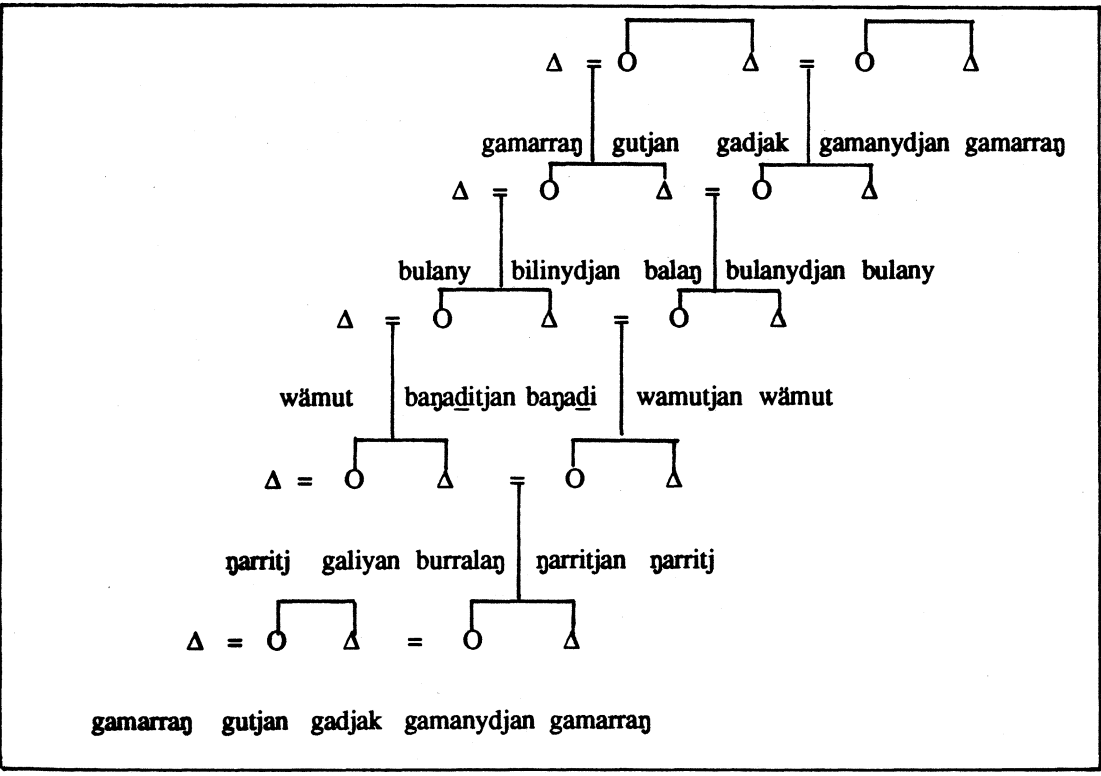

Figure 4.9. Second Choice set of Marriage relationships according to *mälk*.

Rarrkminy and her brothers belong to Gundapuy - Djambarrpuyŋu clan and hence simultaneously to the place known as Djawal'ŋur. The clans coming from Rorru and Nŋurruyurrjturr combined together with her clan in the lower left of Figure 4.10, form a single set. They are in a *yapa* (sister) relationship to her own clan and the sites are in a *yapa* relationship to Djawal'ŋur, though she does not call her site or her own patrilineal clan by that term.¹⁴ The three sites have some major *madayin* (sacred objects) in common, and this holds them in a close relationship to each other. The fact that they are in apparent degree of competition concerning who actually receives the gifts of daughters as mothers for their clan, could be expected to create a degree of tension between them.

In the figure the next group in the direction of the arrow is made up of the clans from Dholtji, Dhälinyŋur and Gurrumuru, all of which are Yirritja sites. It is to them that Rarrkminy and the other daughters from her group of sites are given as mothers for the children of these sites and as mothers-in-law for the children of the next group. These sites in the second set are *waku* (sister's child) to the sites in her own set. Her actual children will also be called *waku* by herself, and by her brothers and sisters.

The sites which supplied Rarrkminy's mother to bear children for her father's and hence her own clan, Naŋinyburra, and Maŋamaŋa, are in her clan's *ŋändipulu*. That is the set of sites/clans in the relationship of mother to her clan and to herself. These two different Warramiri clans supply the women to bear children not only for her clan, but to the other two clans in her group which she calls her *yapapulu*. The group of clans in a sister relationship to her clan.

Continuing to follow the arrows in the reverse direction the sites Marapay and Gäriyak are in the relation of mother's mother to her own set of sites. The sites

¹⁴ A person calls their own clan lineage their *yarrata* (lit. string).

and the clans in the group are in the relation of *māri* to her group, and she calls all the members of those clans her *māripulu* (mother's mother's set of clans). She calls them *māri*, and they call her *gutharra* (sister's daughter). However because of the circular pattern of the transfer of women, her group of clans is also in the relationship of *māripulu* to them, although her own *gutharra* (daughter's children) belong to the site and the group.¹⁵

Her *māripulu* set receive mothers for their children from Dholtji, Dhälinyŋur and Gurrumuru. Her *māripulu* set calls these sites *ŋāndipulu*, the set that supplies their mothers and the sites that are in *ŋāndi* relationship to their sites. Rarrkminy's set of clans refers to them as their mother's mother's mothers or *waku*. The set of sites/clans in this relationship are her *wakupulu*. Where the actual matriline has followed the ideal around the circular pattern, this means that Rarrkminy's sons and daughters (whom she calls *waku* or sister's child) will belong to a clan and a site related to her clan and site as their mother's mother's mother. They are *wakupulu* because of this relationship, that is as children of her *yapa* clan, not because they are her children. In this way, she as *ŋāndi* for the group is the final of the three stages of the "inside" transfer of their *maḍayin*. She is *ŋāndi* in the dual sense of having born their children who are *waku* to her, and also brought out into the open for her *wakupulu* (mother's mother's mother's clan) those who will continue the *wakupulu*'s *maḍayin* (sacredness).

Through this circular pattern there is a set of sites and a corresponding set of clans relating together in a theoretically fixed structure. Any one site/clan within a set can give daughters to any of the clans in the next set. This was Rarrkminy's explanation of the ideal, but as she said, sometimes the daughters can be given in the opposite direction, though the relationships between the sites appear to be fixed.

¹⁵ It appears that while people, sites and sacred items can be in a reciprocal *māri:gutharra* relationship, a clan can only be *māripulu* to another, there being no term *gutharrapulu*.

Within the ideal was room for flexibility and the three sites with the separate relationships of exchange of daughters with Marapay are part of this. Rarrkminy's own *waku'mirrigu* (actual mother's mother's mother) had come from one of them.

A different "ideal" set of sites, which pass on their daughters in the same way as Rarrkminy described was listed by Nyambi from the Gumatj Yunupijū clan whose homeland is at Buranyburany. The pattern of relationships which he identified included some of those places that were in Rarrkminy's sets, keeping them in the same relationships to each other as they were in hers. He also replaced some of the ones in her list with some locations that were in an established relationship to his own group, describing the same giving of women to be mothers for the clans in the same direction as she had. (See Figure 4.11.) Keen's (1978:131) descriptions of cycles of marriage over six lineages appear to be able to be superimposed over these ideal patterns, as where these overlap with the contents of of the two figures, the sequences are found to match.

The fact that these two sets maintain constant relationships through the transformation from one clans perspective to that of another's appears to indicate the possibility that there is a way that all the clans in Arnhem Land could be fitted into four groups. If this was so it would neatly establish the semi-moieties claimed by Shapiro (1981:109). I was not however able to establish this consistency and I also obtained some patterns which conflicted with the above two sets.¹⁶ The two sets while consistent with each other also contain variations from the groupings of clans given by Shapiro, with some clans in the opposite quadrants from his lists. All this appears to prove is that within the Yolŋu cosmos there is some idea of sets of clans or sites functioning in this way. In practice however, the ideal seems to vary from group

¹⁶ Shapiro (1981:110) noted that these groupings of clans were not universally agreed with, there is, however, the possibility that we both missed subtle discriminations being made between different lineages of the clans in question.

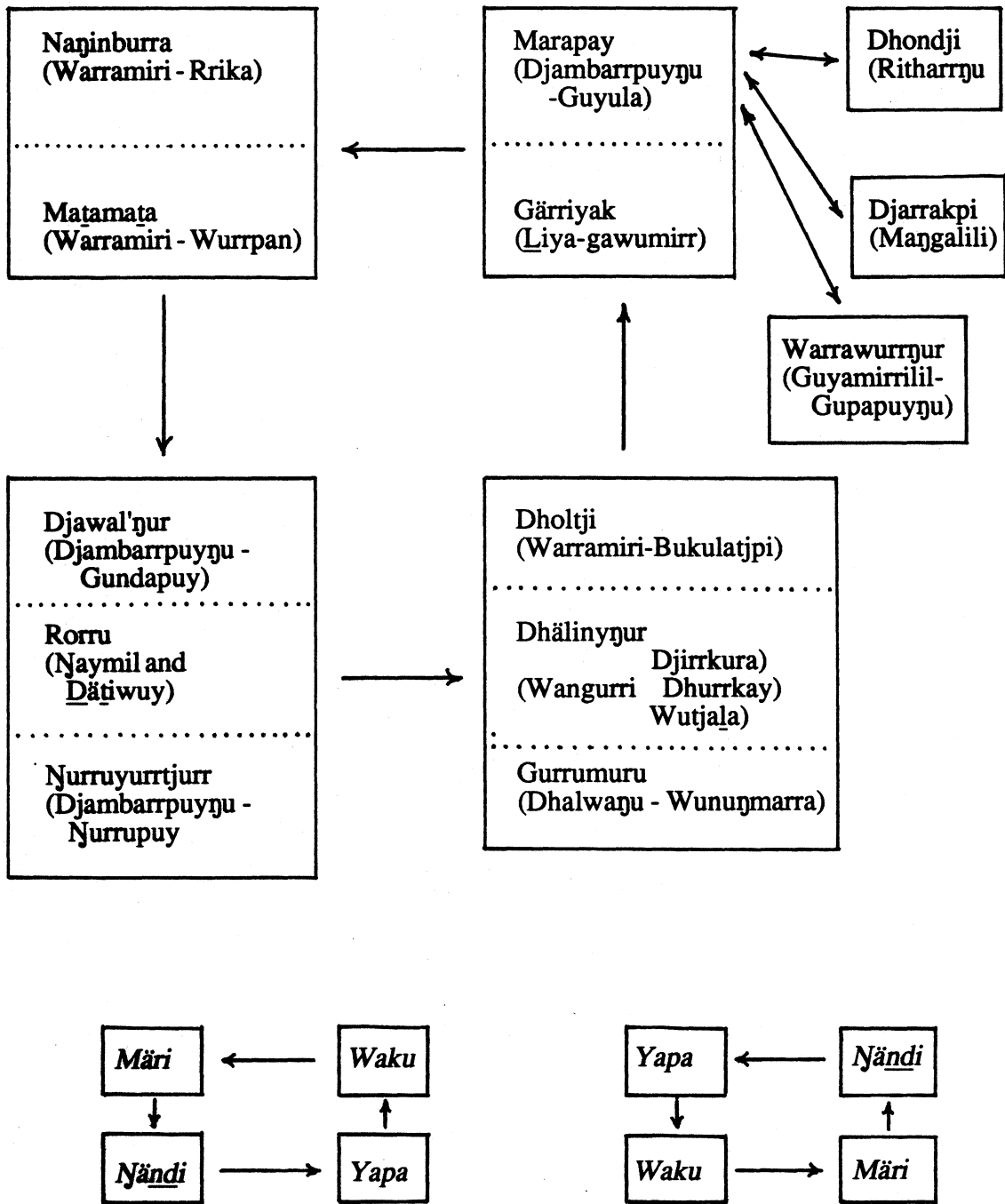

(Cyclical pattern of transfer of women).

Figure 4.10. The ideal marriage pattern for Gundapuy - Djambarrpuyngu clan.

to group in accord with what may be the attempts of different individuals to manipulate the ideal in their own favour.

In addition to the notion of an ideal relation between sites which governs the movement of women and the obtaining of wives, there are several alternative ways by which a man may obtain a wife.¹⁷ A man may marry a woman who is mother's brother's daughter, or mother's mother's brother's daughter's daughter, who is the daughter of his *milmarra* (promised wife's mother). These descriptions may or may not refer to the same woman, and either of these could, but may not necessarily neatly fit the ideal system just described. The levirate, common in the past, was an alternative way of obtaining a wife, but appears to be becoming less common than it was. I can suggest two factors which may be affecting this but there may be others also. Firstly men are living longer with the improved health care, and there being less disparity in the ages of spouses, when a man dies his wives are often now beyond the age for child bearing. Secondly, women appear to be more autonomous than they were and widow's pensions and supporting mother's benefits have given them more economic freedom than they had previously.

Imposed over the top of the kinship system, is the *mälk* (subsection) system (Figures 4.8 and 4.9).¹⁸ This system provides one further way of supporting an argument in favour of the legitimacy of a proposed marriage. Such argument is then based on whether a couple are in right relationship according to the optimum *mälk* terminology. The system is used by the Yolŋu chiefly to support such arguments as may have weak or non-existent support through the genealogical system, and is consistently treated as having less significance than the older system. As Scheffler (1978:496) says, "As far as the practical business of arranging marriages is

¹⁷ All of these have been adequately described in the literature and I only comment on aspects which throw light on Yolŋu understandings of the cosmos.

¹⁸ This is fully discussed as a classificatory system in Warner (1958:116-124), Webb (1933:406-411) and Shapiro (1981:135-150).

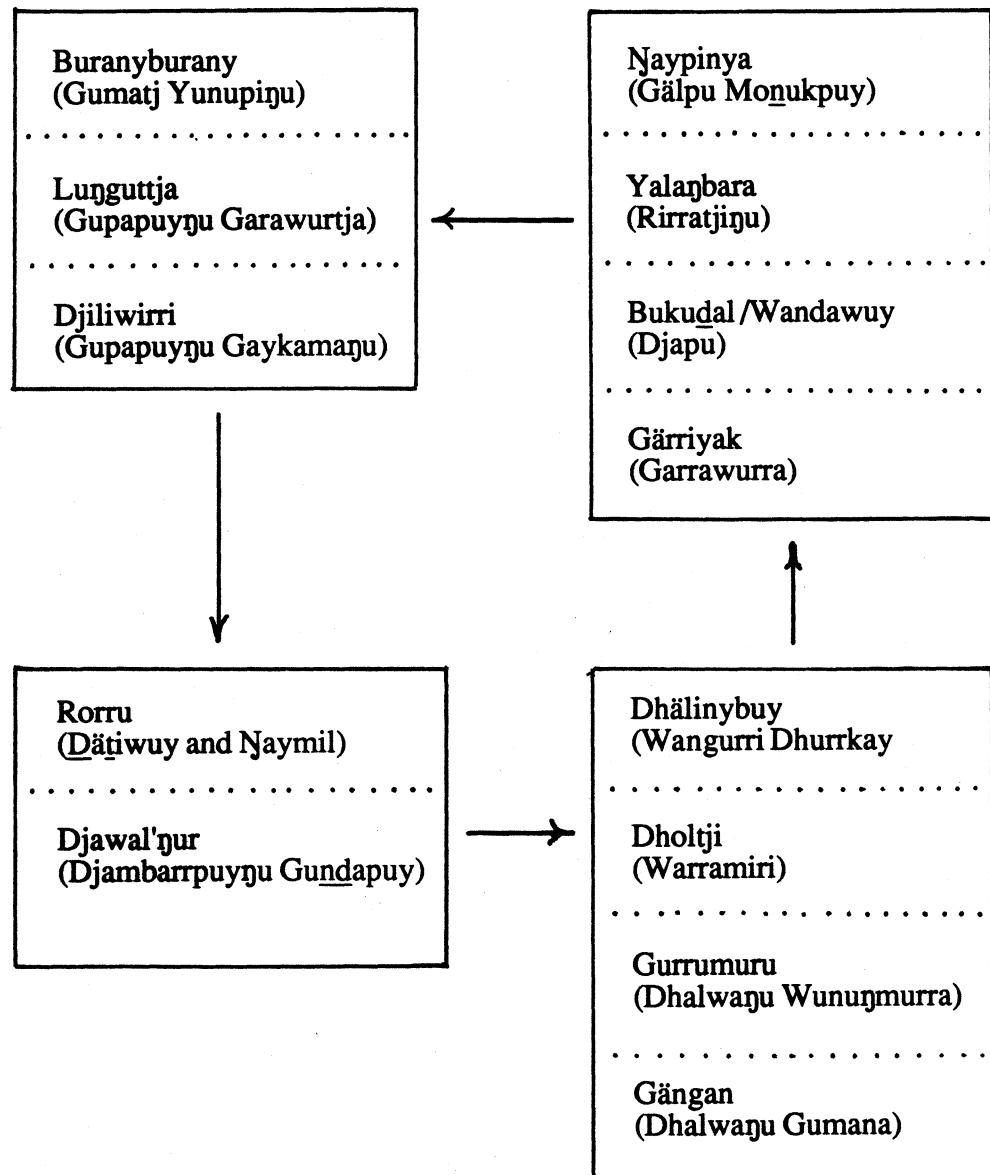

Figure 4. 11. The ideal marriage pattern for Gumatj-Yunupijū clan.

concerned, the subsection system is not merely redundant, it is largely irrelevant". One of its primary functions however is often ignored and that is its use in providing a means of establishing what relationships exist with other non-Yolŋu people, including non-Aboriginal people, and as a way of referring to each other without using names or kin classificatory terms (cf. Shapiro 1981:146).¹⁹

The marrying of *maŋutjimirri* (lit. eye-having = girlfriends) possible occasionally in the past with considerable difficulty is now common, though this is frequently frowned on by the parents of both on such grounds as the couple not being in the right relationship, or one of them being below the status of the other.²⁰ When a marriage, no matter how non-traditional has become established and accepted, attempts are made to "make things right". This may take the approach of changing the man's relationships so that he is put into an acceptable category to be the woman's husband, or it may be achieved by seeking to find some common links between the families through commonly held sacred things. Rarrkminy, reminiscing on the changes that have occurred in the establishment of marriages, describes the justification that was achieved for the marriage of one of her daughters to, at that stage, one of the most prestigious younger men in Arnhem Land. She said that,

The old people kept *rom* (the system). Now use *Balanda rom* (white man's system). No promises now, but *gamunungu rom* (sacred design traditions). My daughter was promised to (a Marapay man), but married *Djiniyini*, and not right, but one *maḍayin* (sacred object) [i.e. they had common ritual objects] for Geluŋ's *māri* (M.M.B.) and *Djiniyini*'s *ṅāndi* (mother) that is *Mirinyiŋu* (whale).²¹

¹⁹ It is interesting to note that being matrilineally patterned and having four terms, it repeats at the fifth and so forms one more exact fit with the other inheritance structures that have thus far been discussed.

²⁰ There is no notion of chastity before marriage, and a girl may have one or more children before marriage, or with the assistance of the government's supporting mother's benefit, and help from her close family may chose to have children and remain single.

²¹ The phrase *gamunungurom* (sacred design traditions) is an alternative expression for *maḍayin rom* (sacred tradition or rule) and refers here, to trying to arrange or justify a marriage in such a way that there is an appropriate relationship between the sacred objects of the clans of a couple.

This justification has the appearance of being accepted at community level as a Gupapuyŋu man said to me that Djiniyini married Geluŋ and Danydjati (his brother) married Lorry. The mother for both men is Wuymirri (whale) and the two men and their fathers are also Wuymirri, so they could marry.²²

The normal "promise" system of arranging marriages, while being spoken of here as being replaced by the white man's system has not completely gone and I need to consider it briefly to draw out some of the ramifications of the earlier discussion on the repeated terms in the matriline of the kinship system. In my examination of relationships I encountered one case where marriage followed the traditional promise system but has some additional aspects that illustrate the significance of adoption.

Daŋataŋa from the Golumala clan married Bändil from the Gumatj Burarrwaŋa clan. His mother and her father are children of the same Gumatj man although they had separate mothers. As a result of this relationship it can be shown that Daŋataŋa married his mother's brother's daughter, a correct marriage in every respect (See Figure 4.12). Ceremonially, it is important for him to have married his mother's mother's brother's daughter's daughter, which would establish a right relationship between him and his male *māri* (mother's mother's brother. Traced through actual lineage, his real *māri* is from the Djambarrpuyŋu Dhamarrandji clan from Bremer Island, and his wife is his mother's mother's sister's son's daughter (See Figure 4.13) However, his mother's actual parents died and she was adopted by a Djapu woman married to a Maŋgalili man. That Djapu woman's brother was Bändil's *ŋathi* (mother's father). By tracing their marriage through the adoptive relationships, Daŋataŋa is able to show that his wife is also his mother's mother's brother's

²² I suggest that this has the appearance of community acceptance but whether it is really widely considered is unknown to me. While this second statement came from a Gupapuyŋu man, his mother is Golumala, so he is in one sense part of the group who want this marriage to be seen to have been achieved with all propriety.

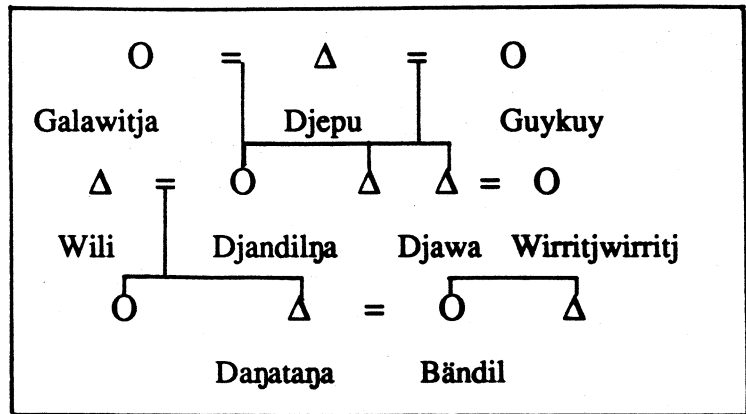

Figure 4.12. Daḡataḡa marries his mother's brother's daughter.

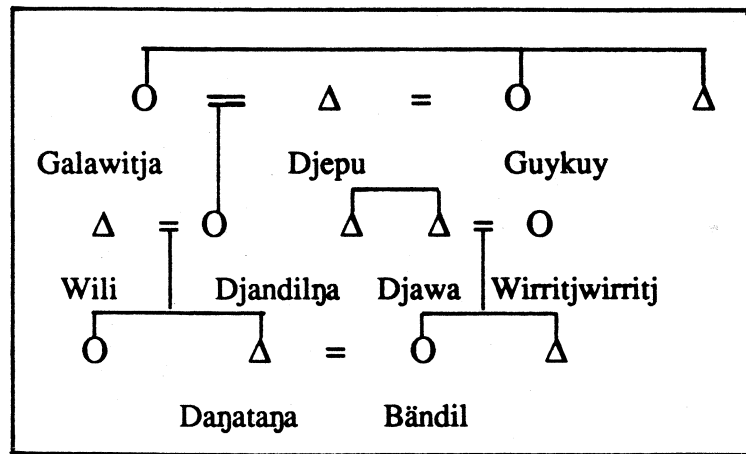

Figure 4.13. Daḡataḡa marries his mother's mother's sister's son's daughter.

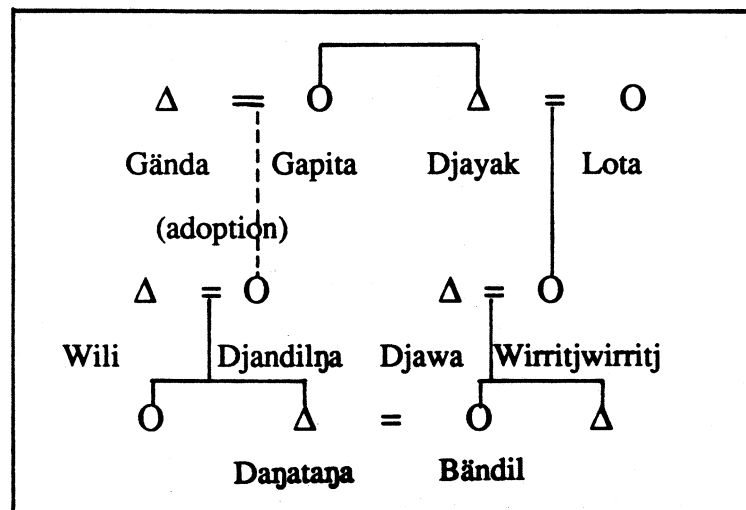

Figure 4.14. Daḡataḡa marries his mother's mother's brother's daughter's daughter.

daughter's daughter which is the optimum ceremonial relationship. (See Figure 4.14). Nevertheless he considers that Djambarrpuyŋu is his first *māri* and Djapu is his second *māri*, placing the actual genalogical line as being more important than the adoptive one. The arrangement for his marriage was, he said, made for him by his two *māri*, referring in this case to the Djapu brother and sister. Daŋataŋa, describing this from their perspective said that,

A man gives a wife to his *waku* (sister's son) so that she will be *milmarra* (mother of a wife) for his *gutharra* (sister's daughter's son). So that man follows his sister's daughter to her son who then follows the line to his sister's daughter's son.

This description of the successive bestowal of women, when superimposed on the kin term chart, then forms another exact match with Yurranydjil's declaration that the *maḍayin* (sacredness) goes inside through the female line for three generations till it re-emerges at the point of repetition in the kinship pattern²³. It also fits exactly when superimposed on Rarrkminy's description of the ideal marriage pattern. Here the transfer of women from group to group starts and ends in the group of sites which share the same sacred items.

On a different occasion Daŋataŋa gave me an entirely different explanation of the system using drawings of the the yam plant transformation of *Baṇumbirr* (the morning star) as a way of talking about relationships. In doing this he drew the original sketches from which Figures 4.15, and 4.16 are reproduced. It should be noted that these are alternative ways of explanation and not an alternative system. He used Figure 4.15 as an illustration of his own clan's development which he described as follows;

"*Baṇumbirr* (the ritual pole with its tasselled strings) is like children growing out of strings from father's seed, then there are grandchildren and soon more.

²³ See earlier discussion on Yurranydjil' declaration.

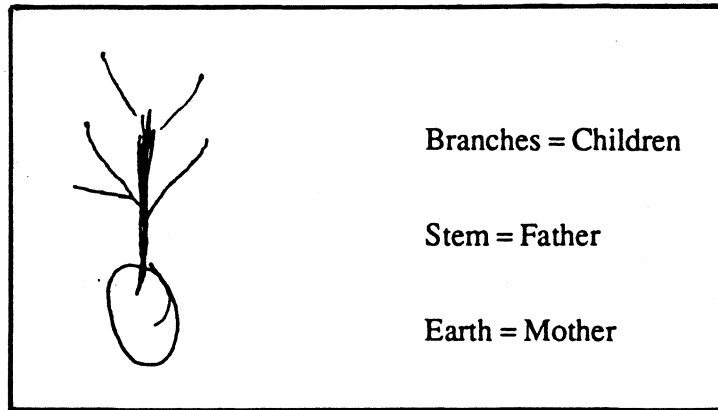

Figure 4.15. Daṅataṅa's illustration of Baṅumbirr as yam as clan lineage.

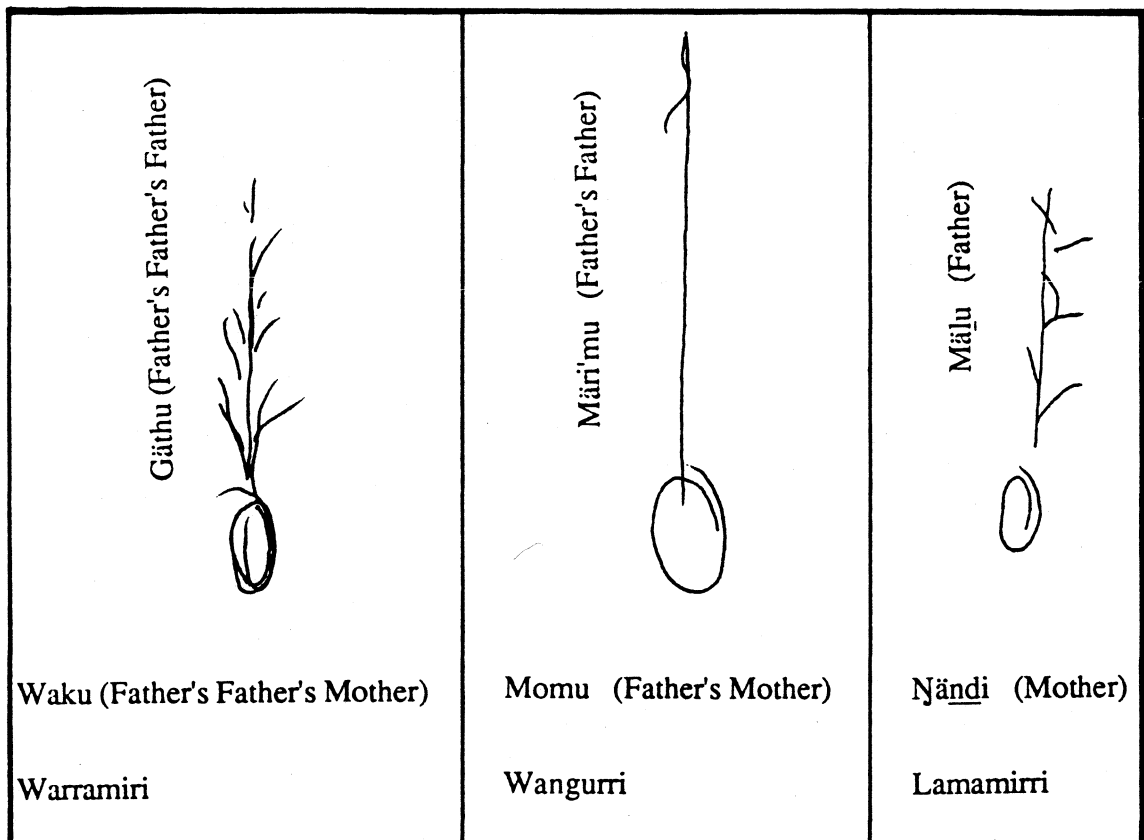

Figure 4.16. Daṅataṅa's lineage illustrated as yam plants

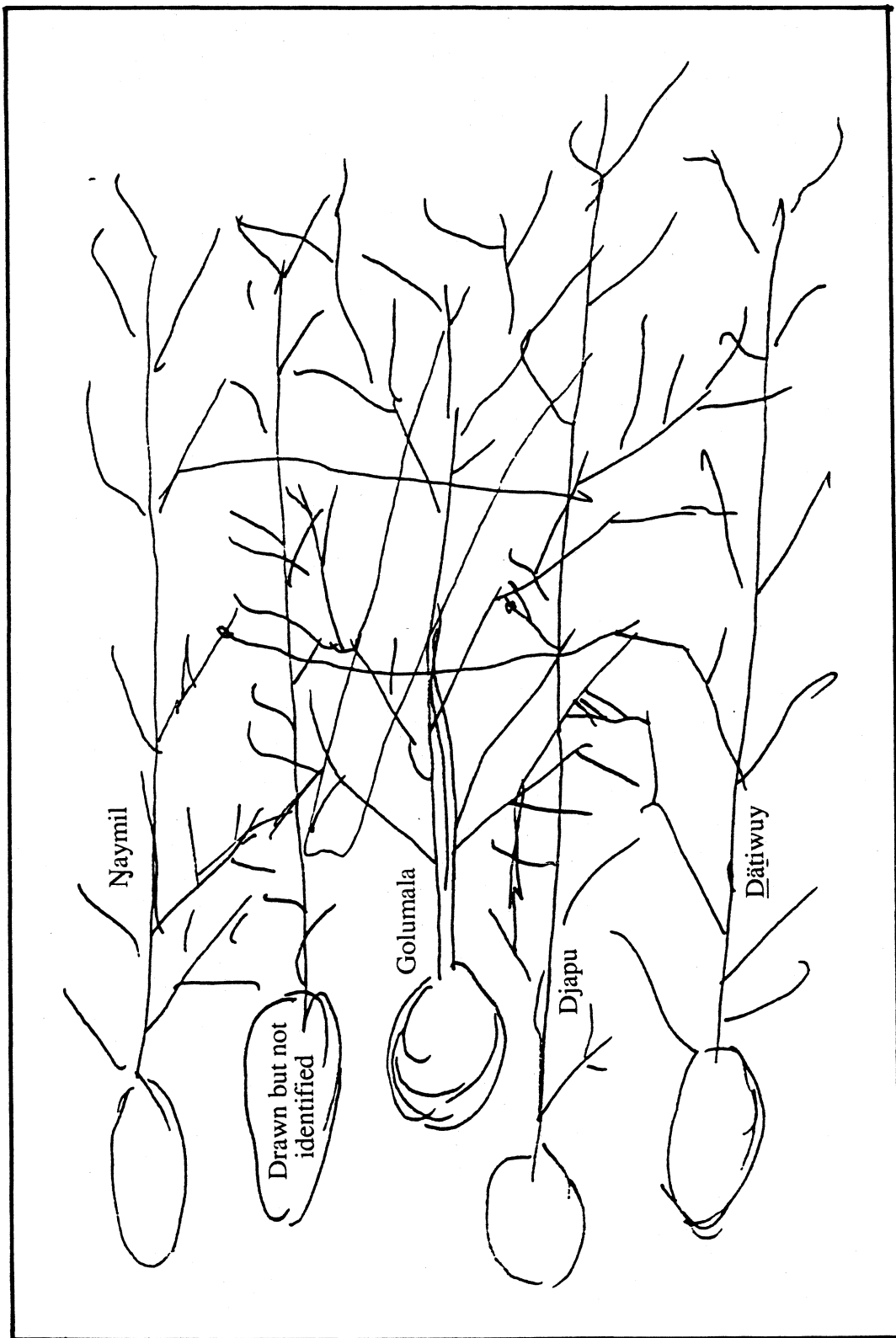

Figure 4.17. Relations between clans in terms of yams.

Place Name	Site	Group Ownership
	East	
Burralku	○	
Gundalmirri	○	Ŋaymil and <u>D</u> ätiwuy
Dhudupunur	○	Murrunjun-Gunbirri Gondarra, Ŋaymil, <u>D</u> ätiwuy
Ŋangalala	○	Bonba bäpurru
Madawurrpa	○	Murrunjun-Mälarra
	West	

Figure 4.18. Clans and places linked by the travels of Banumbirr.

It is like the *duyŋa* plant (a yam) that grows in the ground. The *dharpa*²⁴ is the father and the stem of the plant, and the branches are his children. Golumala use Maŋgalili and Lamamirri to produce. My *māri'muwu ŋāndi* (father's father's mother) was Warramiri and my father's *ŋāndi* (mother) was Wangurri."

After indicating that the soil in which the yam was growing represented the mother, and hence the site from which the mother and her clan come, he drew a series of three similar yam plants growing in different sites (Figure 4.16) saying that one represented his father's father's mother who was Warramiri, one his father's mother who was Wangurri and the third his own mother who was Lamamirri. Thus in three generations three different relationships, with clans from three different sites, had been activated in the growth of the clan.

Daŋataŋa drew two other drawings to illustrate the ways in which Gapiny clans relate together and also how Djapu clan can function as an intermediary with them. The first of these drawings, Figure 4.17, illustrates the relations in terms of the yam transform. In this case each yam represents a single clan and the intertwining of branches represents the relations between the group which, as they are described, match exactly with the "ideal marriage patterns" described earlier.

Dätiwuy, Golumala and Ŋaymil are *duyŋa* (yam). Each plant is separate, but together bring fruit (offspring) to each other; *milmarra* (promised wife's mother) or *māripulu* (mother's mother's clan) or *gutharra* (daughter's daughter). A Ŋaymil daughter²⁵ might be *maralkur* for Golumala. That starts fruit between. Djapu may be *maralkur* for Golumala or Ŋaymil, or Ŋaymil for Djapu, or Golumala for Djapu or Dätiwuy, or Dätiwuy for Djapu.

²⁴ *Dharpa*, (wood) is here referring to the wooden core of the ceremonial yam object. the wooden section of which represents the root section of the yam.

²⁵ There is a difficulty in this quote in the use of the word daughter in English to translate the Yolŋu word *gāthu* (man's child of either sex). *Maralkur* is term for the wife's mother's brother when viewed from the perspective of the receiving individual, a man who has responsibility for the distribution of his sister's daughters in marriage.

The intention of his statement appears to be that, the female child of a Dhuwa man of one clan in the group is potentially a wife's mother for children of another clan in the group. In saying this he was listing the clans that are in the one group linked by *Banumbirr* (the Morning Star) and saying that as the women produce children, that through the matriline there will come back to other members of the group women who will bear more children with the same *madayin* (sacredness) and hence more who share the common aspects of the identity of the group.

This same relationship was expressed in an entirely different way in relation to the travels of *Banumbirr* (the Morning Star) and the sites that are linked by these travels. Drawn from the last of Daṇataṇa's sketches (see Figure 4.18.) it relates Djapu clan as *māri* (mother's mother's clan) to the next groups in the journey, with them being in a reciprocal relationship of *māri* to Djapu. This too exactly fits the above mentioned marriage patterns in that it exemplifies two groups of clans of one moiety being in a reciprocal *māri* (mother's mother) relationship to each other. As it was drawn in the figure (which ignores the Djapu connection), *Banumbirr* moves from East to West, following the direction of movement of the actual morning star across the succession of clan territories that are linked by the ceremonial complex.

²⁶According to Daṇataṇa,

all come from one mother, and all have one father who is Djapu. All the other clans and sites are *māri* (mother's mother) to Djapu, but also Murrugun - Gunbirri, Gondarra, Njaimil and Dätiwuy call Djapu *māri*, while at the same time being *māri* for Djapu.

In this he is placing the origins of the Morning Star with the Djapu clan, and hence the initiative for using it as a basis for establishing relations with them.

²⁶ It should be noted that this is his summary according to a Golumala clan [Gondarra] perspective. Other versions of the travels list different clans related together by *Banumbirr* but rather than cancel out any of the details he supplied, these tend to supplement them according to the focus of the speaker at the time.

Each of the separate descriptions of ways to achieve marriage that have been discussed to this point, apart from the "sweetheart" arrangement, has the potential to overlap with each of the others so that it is possible, at least in theory, to fulfil all the systems, including the *mälk* system, simultaneously. Throughout all the systems, ideals and variations of description that I have presented in this section it is possible to see a common strand which, represents the ideal marriage as that between a man and his mother's mother's brother's daughter's daughter as has been adequately shown by Keen (1978) and Morphy (1977). This is however the pattern from the perspective of a man gaining a wife. The bestowal pattern is more complex than this. Viewed matrilineally, a man's aim is to so establish arrangements between other clans that his sister's daughter's son will control the bestowal of his sister's daughter's daughter's daughter in such a way that she will produce children who will care for his *maḍayin* (sacred items) and who will in fact be living transformations of his *maḍayin* in the same way that he is. Within this pattern of the bestowing of women and the caring for sacred items is the basis for almost if not all the patterns of obligations between clans.

THE MORE DISTANT WORLD: RELATIONS BETWEEN CLANS.

To this point I have simply identified Yolḡu groups by recording whatever name a particular group has been given when being discussed. Yolḡu groups have proven difficult for Anthropologists to classify according to any fixed set of determining characteristics. I am not convinced that a fully satisfactory solution has been recorded. I certainly have not found any single factor or set of factors which can be adequately applied to all groups.²⁷ Warner (1937/58:33) appears to have

²⁷ Part of this is because the Yolḡu appear to identify groups by a whole range of factors, but not to identify all groups by the same sorts of things. The result of this is that a number of groups appear to be identified by unique sets of factors.

decided that the basic Yolŋu social unit was a patrilineal group which he identified by the term "clan". This is the term that the Yolŋu use when speaking in English, though not necessarily with the same English meaning as Warner. R. Berndt (1976:135) claimed that these groups could be discretely identified using the paired *mala/matha* classifications and so the groups which he identified as,

a dialect unit which is also a territorially anchored unit substantiated by its linked *mala*, which in turn provides the mythic justification for its spatial grouping

Shapiro noted (1981:20) that the Yolŋu "call such a unit a *mala* in secular contexts, a *baparru* [*bäpurru*] in ritual ones". *Matha*, meaning language, is certainly one satisfactory determinant, but *mala* simply means plural or group or multiple and there is a problem in its use to classify such groups. It is simply a term for "group" and refers to any group at any level. Shapiro, searching for a more appropriate label chose the word "sib" for the same group. Of the sib he says,

Sib charters are non-genealogical. All the members of some, though by no means all, sibs are demonstrable agnates, but whether or not this is so is not culturally important. Rather the unity of the sib is expressed in terms of its association with a particular estate, and with the ritual and mythic forms connected with that estate.

In addition to the problem of finding an adequate terminology to unambiguously identify such basic groups, there is an added complication in that the Yolŋu processes of identifying groups of different kinds overlap with each other at any apparent single level of grouping.²⁸ A good number of groups can be identified by a combination of the language they speak, their major religious site, and whether the location of their sacred objects is in a salt water or a fresh water place. These are the types of basic social units that Warner, Berndt and Shapiro have attempted to identify, the groups I have chosen to call "clans" (following Keen, Morphy and in some cases, Warner). The meaning which should be attributed to that term depends on

²⁸ They also simultaneously overlap with each other between different hierarchical levels.

the context of its use, in the same way as the word *mala* does when used by the Yolŋu.

Yirritja	Dhuwa	This/Here Class
Gupapuyŋu Gumatj Maŋgalili		Dhuwalamirri
	Djambarrpuyŋu Djapu Liya-gawumirr Liya-galawumirr Dätiwuy Marrakulu	Dhuwalmirr
Maḍarrpa		Nji'mirr
Wangurri	Gälpu Golumala Ŋaymil Rirratjiŋu	Dhaŋu'mi
Warramiri		Djaŋu'mi
Golpa		Nhaŋu'mi
Dhalwaŋu	Djarrwark	Dha'iyunamirr
Ritharrŋu	Wägilak	Yaku'mirr
	Marraŋu	Dhuwalnydji'mirr

Figure 4.19. Some of the Yolŋu Language groupings (not exhaustive).

Not all groups appear to be able to be identified in this way and, to complicate the apparently simple task of identifying the groups we are considering,

there are a whole range of different bases by which groups link together in larger affiliations and sometimes these larger affiliations are given the same names as are applied to the "clans".

It is appropriate here to examine some of the complications of the Yolŋu process of identification of groups and of individuals. To do this I will consider some aspects of the groupings of people who fall into the category "Djambarrpuyŋu". I have examined the cosmos of human relationships at the level of the individual and his close world, the individual in the changing structure of residential groups over time, and the individual within the network of intermarrying clans.

Some of the very large groups such as Djambarrpuyŋu are a source of difficulty in identifying just what is or who are being referred to by the use of the name. Djambarrpuyŋu according to Warner (1937/58:44,45) is the name of the language spoken by several groups of people. However it also functions as a name for the overall group, which is composed of several hundred people. Within Djambarrpuyŋu there are numerous discriminations which serve to identify smaller groups within the whole, yet at the same time there appears to be the notion of a corporate identity as a single unit.

The identification of what is meant by Djambarrpuyŋu is further complicated by the fact that the Yolŋu classify the distinctions between language groups according to the word used for "this/here". Djambarrpuyŋu is just one of the Dhuwalmirr (*dhuwal*-having) groups. Similarly Gupapuyŋu is just one of the groups who speak *Dhuwalamirri* (*dhuwala*-having). I have included a partial list of groups and the languages that they speak according to Yolŋu classification in Figure 4.19, a list compiled under the instructions of one elderly man at Galiwin'ku. In this figure it will be noted that there are in fact two ways in which the Yolŋu classify languages that are spoken. One of these is apparently used to classify clan dialects and sometimes uses what is often referred to as the clan name for identification, the other,

based on the "this/here" classification links together sets of these groups and in several cases crosscuts the moiety divisions. Frances Morphy (1983:2-5) discussing the work of Zorc (1978) Schebeck (1968a and Heath (1978) whose lists are all different from those given in the figure, concludes simply that "It is not possible given the present state of knowledge, to subgroup these languages definitively".

	Site Affiliation	Description.
1.	Nurruyurtjurr, also called Nurrurur or Gämurrurur.	We call them Nurrupuy mala (the group who belong to the point). Malawa and Galpagalpa belong to that group.
2.	Gurala, also called Gundarur or Watapanur or Baman'gur.	We call them Gundapuy mala (the group who belong to the rock).
3.	Djarraya area (Napier Peninsular).	We call them Djarrayapuy or Madharrakama. Djalangi's mother is from there and a few others at Rraminingin.
4.	Marapay.	These are Liya-dhalinymirr Djambarrpuyru related more to Garrawurra (Surname used by Liya-gawumirr people) because they sing songs using clapsticks only and not didgeridoo, though sometimes they follow us and use both.
5.	Inland like Mirratja.	They are Guyula Djambarrpuyru.

Table 4.1. Djambarrpuyru groups according to site affiliation.

When I asked one man what was meant when a person was spoken of as being Djambarrpuyru, he said that,

If say Djambarrpuyru mala, then first response is groups and *dhäruk dhuwalmirr* (the language group having *dhuwal*) . Think of *wanha wäna* (where is the place), places of significance and affiliation, *madayin* (sacred elements) and *ranga* (sacred objects). All speak *dhuwalmirr* but all have different dialects

He then listed the following as being *Dhuwalmirr* speakers,

Djambarrpuyru Dämbu-dhalinymirr
 Djambarrpuyru Guyula

Djambarrpuyṇu Dhā-gurrpuluwuy
Djambarrpuyṇu Liya-gawumirr
Djambarrpuyṇu Dāmbu-galawumirr (buyu-wititj)
Djapu,
Marrakulu
Dātiwuy

Having listed off all these groups as speaking the same language, although as he said, separate dialects, he described distinctions between five different Djambarrpuyṇu groups on the basis of particular named sites as shown in Table 4.1.

Thus for him, to be Djambarrpuyṇu had two entirely different meanings. Firstly to be Djambarrpuyṇu meant to be a member of one of the groups which speak a language called by that name or even wider, to be a member of one of the groups that speak one of the *dhuwalmirr* dialects. Secondly to be Djambarrpuyṇu could be to be affiliated with one of the groups of sites in which Djambarrpuyṇu people have particular interests. That is, Djambarrpuyṇu could mean either language or people and again context is the main determiner. Of his two lists, it is of note that there are only two groups that are named in both and one groups listed as Djambarrpuyṇu- Liya-gawumirr in the language list is implied to be not Djambarrpuyṇu in his land site based list.

On other occasions I have been quite different listings of Djambarrpuyṇu groupings. One senior man said,

There are three groups of Djambarrpuyṇu; Nininyṇu Dhamarrandji, the main central Djambarrpuyṇu, Guyula or Marra-Dhalinymirr or Liya-dhalinymirr, and Dhamarrwaṇa Dhamarrandji.

It is of note that while two of his three groups were not named in the list of land based groups (Table 4.1), his second group is described as two separate groups in it. Another man, giving a series of names that relate to himself and his father's group said that,

Dhamarrandji is the same as Dhamarratjpi, also called Dhamarrarrwaṇa, and Nininyṇu Dhamarrandji and Wāṇa-gundapuy mala. They relate to the spear of , but you better not print its name.

This listing of names identifies his clan with the second group in the first man's list (they are both Gundapuy) and with the last one of the senior man's set of three, but of more significance here is the emphasis on the multiple names of a single group which identifies the group particularly in relation to a ritual object. A single clan group may also have multiple ceremonial bases for their identity. Maratja, who is from the Gundapuy Djambarrpuyŋu spoke of one aspect of it in this way,

All our songs are from the sea and the shore, but they've given us the ḍiltji (inland) songs. It was like this. Two old men went to Wägilak country. They were Djirrkididi, my father's *māri'mu* (paternal grandfather) and Gunbayalma, who was Golumala [clan]. They got songs from there. Maybe they traded *mālka* (a ritual string) or *ranga* (sacred object) then they got Wuyal so that makes us also Dhurili Djambarrpuyŋu which relates to Marraju. They are *māri* (mother's mother's clan) and Golumala is *number two māri*, (mother's mother's clan of slightly less significance).

In this way his group has gained by exchange, a new set of relationships which includes a new name series.²⁹

	Djambarrpuyŋu group	Descriptive features
A.	Djambarrpuyŋu buralka.	Bundurr ga <u>likan</u> are litjilitji, marrawuŋgu, <u>ḍatayana</u> . <i>Dhuyu ṇayi yāku</i> (sacred those names like Yabubu, used when <i>djirrikay</i> (invoke names of) inland place named <u>Badaypaday</u>)
B.	Djambarrpuyŋu Dhamarrandji,	Dhamarrwaŋa from Djawal'ŋur, Gurala and Binyambi. <u>Likan</u> connected with <i>bul'manydji</i> (shark like Maratja) are bakada, nyulunyulu, garrulkiri, waḍunyikpa, nyikuymirri, gululuwaŋa, <u>milan</u> , <u>dārrkamawuy</u> ,
C.	Djambarrpuyŋu Wutjara	(most use the title Dhamarrandji) from Ŋurruyurtjurr / Bayilki / Ginilawurru / Dhäthu / Mipuru. Connected to Wuwarku (a snake) like Keith Djiniyini. <u>Likan</u> are wurrputtja, māŋgani, riyariya, wurrpududu, (connected with Wuwarku).

All the above groups can be *buyu-djarrak* (having tern) but tendency for "C" to use the term most, but all three can sing *djarrak* (tern).

²⁹ I was not able to determine whether there were any other groups which shared the term *dhurili* other than those mentioned.

D.	Dhurili Djambarrpuyṇu	are all those who sing songs about Wurray. related to Marrāṇu and Golumala and <i>diltjipuy manikay</i> (songs of the inland country). Dances with handful of leaves. The man named Djirrkididi from "B" went to Muypan /Djanaṅgirr /Yalawiya, escorted by old Gunbayalma (Wili's father, who was already Dhurili). There they met with Marrāṇu and Wāgilak. They had a ceremony and exchanged <i>raṅga</i> (ritual items) and songs that went with that. Didn't have <i>malka</i> (particular white-feathered string) before that. It is <i>Yarrpanygu mulmul</i> . (If mix up <i>guku</i> (honey) and stir it, up comes white and that's what <i>malka</i> represents) <i>ganimbirrki</i> , <i>dharrkuymirri</i> , (sacred names for the honey) <i>ṅaraka ṅayi buluwywuy</i> , <i>mulmul</i> , (like bubbles in the honey, real sweet one).
E.	Djambarrpuyṇu Ṇaladharr	are <i>buyu-djarrak</i> (related to the tern) too, and maybe the same <i>likan</i> as "C", but different <i>maḍayin</i> (ritual items). That is <i>dārrpa</i> (a snake). They come from Djarraya.
F.	Djambarrpuyṇu Liya-dhalinymirr	have <i>wolma</i> (the thunder cloud that stands at Marapay and Gäriyak) They are from Marapay. Djambarrpuyṇu Liya-dhalinymirr together with Liya-gawumirr are the <i>djirrikaymirr</i> (ones who call invocations) for any Dhuwa <i>ṅarra</i> (ceremony) within our region. They share <i>wolma</i> (thunder) and both are Djaṅ'kawu.
G.	Djambarrpuyṇu Guyula	are close to "F" but separate by classification.
H.	Djambarrpuyṇu from Dhambaliya	are connected with "C" and "E" and also with Rirratjiṇu. A <i>gunda</i> (rock) there. <i>Likan</i> are <i>djiwarr'miny</i> , <i>mānala</i> , <i>ṅapawuttharra</i> , <i>dhāṅgal</i> , <i>ṅaritjpal</i> , <i>Jirrilirri</i> . There is another <i>gunda</i> (rock) near Ṇurruyurtjurr.
We all borrow songs from each other (except Liya-dhalinymirr who have no <i>yidaki</i> [didgeridoo]). Each has own ownership. The tune is the same with slight variations. Further inland is higher.		

Table 4.2. Distinctions made between Djambarrpuyṇu groups.

Rarrkminy, from the same Gundapuy Djambarrpuyṇu group helped me to establish a chart of the categories that were used to classify Djambarrpuyṇu groups and in doing so started with the names of a number of the senior men, some of whom were already deceased. Her categories were developed into the table shown in Figure 4.20. It demonstrates that senior women have a considerable knowledge of what is

supposed to be men's business.³⁰ In the table there is no use of the word "mala" discussed earlier. The column headed *Bäpuru* contains what are probably the nearest equivalents to a clan name.³¹ The heading *Wäna* (place) refers to the geographic type of the general location of the site associated with a major sacred item. *Wäna Yäku* (place name) is in this table, the name of the major area owned by the group. *Madayin* (sacred item) is the general name for the group's major sacred item, and *Bundurr* is one name given to the set of special names associated with the *madayin* that are part of the group's identity. Note that this is not a comprehensive list of Djambarrpuyŋu groups. At a later time, in an attempt to clarify the distinctions between the different Djambarrpuyŋu groups, Maratja listed them off for me with basic information that was intended to describe the major features of the identity of each group. In this he named nine groups as shown in Table 4.2

In the main all groups (*bäpuru*) are related to all other groups through relationships established through some religious property held in common by them, whether this be land or some other element such as song, myth, dance, design, or three dimensional objects used in rituals. There are on the basis of such shared interests in religious properties, a wide range of what might be called meta-groupings of clans. Such groupings overlap with each other to such an extent that a *bäpuru* (clan) group may belong to a number of such meta-groupings with a different association of clans in each. They may be named or they may simply be identified as "those who share '.....' with us."

Warner (1958:37), labelling these meta-groupings as "phratries", appears to have dismissed them as "a weak attempt within the culture to create new and larger groups than the clan to control the intra-moiety antagonisms". While they do have some role in this, it appears that the main purposes of such sharing of religious

³⁰ the gaps in the table were not necessarily gaps in her knowledge, but the result of interrupted recording.

³¹ See the earlier quote from Shapiro.

Person (By name)	Bäpurr (Group)	Wäpa (Place type)	Wäpa (Place Name)	Madayin (Sacred Item)	Bundurr (Invocation)
Burrminy Bäni Maminawuy Yalkarriwuy 2 Malawa Galpagalpa Djumbala	Buyu-djarrak	dhä-dhudipuy dhä-rañipuy ñurrupuy (of the point)	Njurruyurtjurr	wuwarku (a snake)	Mängani Wulunayñu Wurrpu <u>du</u> Riyariya Wurrputtja
Dhakayima Mararru	Ñaladharr		Djarraya and Djadawakñur	därrpa (a snake)	Mängani etc
Nalkathi Rarrkminy Wunbaya Yirrilil Guruwanawuy Muluyulk Gunbuku 2	Dhamarrandji	dhä-rañipuy (of the coast) garratapuy gundapuy (of the rock) miñanbuy darrkamawuy dhä-malamirr	Djawal'ñur	buñmanydji (shark)	Luluwaja
Djorppum Gunbuku 1 Milamba Galajarawuy Djilwuywuy Burrukala Djekurr	Guyula Liya- dhalinymirr Wulma murryun	dhä-gupapuy	Marapay	djarrak (tern)	own bundurr

Figure 4. 20. Djambarrpuyñu classifications (after Wanymulu).

property is to establish relationships which bring with them the potential for obtaining wives, and thus the maintenance/continuance of the individual's *maḍayin* (sacredness) and almost incidentally some potential for increased harmony between the groups.

Within this complexity of clans and moiety specific clan groupings, every marriage brings with it a set of cross-moiety interclan affiliations, and when a man marries women from more than one group, his children by different wives then have different sets of affiliations. To again quote Daḡataḡa,

There is a difference between my side of the family and (my brother) Djiniyini's side. We had one father, but two different mothers. My *māri* [clans in relationship of mother's mothers] are Djapu, Djambarrpuynu, Liya-gawumirr, and Dätiwuy because my mother came from them. My close *māri* are Djambarrpuynu (close *maḍayin*) because *māri* married both. Djiniyini's mother came from Rirratjiḡu, Dätiwuy, Djambarrpuynu and Ḥaymil. Rirratjiḡu and Dätiwuy are close *māri* for him. Ḥaymil fits in but not close because old lady came from Rirratjiḡu and Dätiwuy and Ḥaymil.

Through just such situations as this one described by Daḡataḡa, that is, the marrying of women with different connections there comes the potential for a small clan to expand and increase its relationships within the wider community. Contained also within this is the foundation by which larger clan may divide and become two separate clans. In the preceding section of this chapter, one aspect of the network of relations of a smaller clan has been described by Daḡataḡa for the Golumala through his use of the yam plant as an image. In this it was shown that there are a group of clans which shared the yam as a sacred object. On the basis of this they saw themselves as being an intermarrying group who, in theory at least, give their daughters to be mothers of wives for other clans in the group. In fact there are two groups involved in this. One of these, the Gapiny group, is made up of the Dätiwuy, Ḥaymil and Golumala clans, and this group is then embedded within a larger group for which I recorded no name, but which also includes the Djapu clan.

When the Morning Star is used as a basis for relationships, Rirratjinu, Gälpu and Murrurjun-Gunbirri are included with the above four to form yet another grouping. In an entirely different set of relationships based on a different set of ceremonial exchanges Golumala form a group with Marraṅu, Wäwilak and a small group of Djambarrpuyṅu people. This group is called Dhurili *mala* (group), a name which I was told indicates that they share together the *mokuy* (spirit being) named Wurray.

In this same way each different ceremonial item shared by Golumala with other clans forms the basis for a different set of relationships. Many of these overlap so that Golumala may have a relationship with any one other clan on a number of different bases, but it appears that no other clan shares with them all the same items. If this state of affairs did arise, the integrity of the group would be compromised. That is, if two clans shared all the same items there would be no way for either clan to declare their identity to be unique.

The result of the development of all these separate meta-groupings, each formed on the basis of a shared religious element, is that each clan is embedded within an extremely complex network of relationships. Each relationship brings with it both obligations and privileges. The obligations are economic, political, social and religious, involving the assistance from a clan to one's own advantage in all those spheres in preference to another clan to which less obligation is owed. Privileges take the form of being able to activate such obligations to one's own advantage. In this subtle and sometimes not so subtle environment of constant struggle for advantage, the wisdom of the elderly who have the knowledge of the privileges and obligations and how to manage them, is highly valued.

CONCLUSION.

In this chapter I have shown how the relationships are structured between individuals, between families and groups and between these and natural species, entities associated with the inside of reality, the natural elements and in particular locations with the earth itself. The personal cosmos is then like a living organism in which the individual Yolŋu finds himself or herself suspended in a multi-dimensional network of relationships.

This human cosmos is not static, but constantly in flux. Relationships are continuously in the process of adaptation, extension or contraction, cancellation or establishment. Throughout these processes, the tools of maintenance and of change, of advantage and manipulation are also seen to be both pragmatic and religious. They include control over both the reproductive capacity of women and over powerful religious elements.

While the relationships are in a constant state of flux, yet it is possible for the Yolŋu to interpret these as representing ongoing transformations in outward appearance of a cosmos that is unchanging and in which all things are in a fixed and permanent relation to all other things. Thus in the human process of interrelating it is possible to perceive an ideal in which a person's unchanging identity is gradually discovered, through a process of revelation. Hypothetically at least, human relations are worked out and marriages arranged on the basis of a pre-fixed order and inherited relations. Yet because of the multiplicity of interweaving strands in the networks of relationships, such marriages are an ongoing cause of contention and manoeuvring. Each party involved being able to justify their position on a different aspect of the "eternally fixed" order of relationships. Once an arrangement has been established and accepted no matter how "wrong" it may be according to some, it will be interpreted over time in such a way that it is seen to be in accordance with the unchanging reality and as a result, the unchanging nature of reality is further reinforced.

CHAPTER 5. RELATIONSHIPS WITH SPACE.

INTRODUCTION.

CONCEPTUALISATION OF SPACE.

The Relationship between Focus and Boundary.

Classifications of Space and the Naming of Sites.

Distance, Location and Direction in Space.

RELATIONSHIPS WITH SPACE.

Land and Identity

Elcho Island.

Dhambalapur.

Galiwin'ku Township.

Space Beyond Arnhem Land.

CONCLUSIONS.

RELATIONSHIPS WITH SPACE.

INTRODUCTION.

In the examination of Yolŋu understandings of space there are four primary assumptions which stand out as affecting most discussions. These are, first that identity is based on focus, and not on delimitation, second that the land is a physical space, third that the land is also a non-physical space, and fourth that the Yolŋu and the land are in living, dynamic relationship with each other. In this chapter I demonstrate the fundamental relationship between these four assumptions and Yolŋu perceptions of space through a consideration of a number of distinct domains of thought. These include techniques used to identify spaces and locate elements in space, perceptions of various different levels of geographic space and ideas of relationship and identity.

The chapter is divided into two main sections. I consider first the conceptual areas which are associated with the identification and classification of physical space, together with ideas of location, distance and direction in that space. The second section of the chapter then looks at human relations with space. Here space is discussed in relation to a person's identity in general terms, then different dimensions of space are examined in succession to see how this affects human relations. In doing this, I start with Elcho Island as a whole, with the various methods by which a tract of land gains its identity and is identified, and with the differences between ownership and rights. Then one area on the south-western corner of Elcho Island named Dhambalanjur is considered, as an example of a sacred site, of the ways in which religious and mythological significance is attributed to such sites, and of attitudes towards such significance. This illustrates a way

of thinking about the land and its sacredness as a manifestation of the inner or spiritual side of reality.

Galiwin'ku township is discussed as a background to demonstrating some of the ways in which the various clans represented in the town declare, and attempt to manipulate, their rights to be part of the community and to be considered in the distribution of community assets such as housing. Finally consideration is given to the ways Yolŋu perceive and relate to space beyond Arnhem Land, from Australia to the rest of the earth, and beyond this planet to celestial space.

CONCEPTUALISATION OF SPACE.

The Relationship between Focus and Boundary.

The concept of focus, introduced in Chapter 1, and already shown to be important in the understanding of identity, is critical to the understanding of the Yolŋu perception of space. It is in the identification of spaces and the ownership of spaces that the notion of focus highlights the differences between the Yolŋu and Western approaches. In a Western understanding of area, space or land, there is the presupposition that what is being considered is defined by delimitation. That is, that a definite boundary exists. Definition of area, space or land requires such delimitation, and this cannot be done without establishing boundaries.

The result of this Western perception is that we have, in the literature concerning Aborigines, a stream of statements concerning known boundaries. For example, Spencer (1921:LXIII quoted in Dixon 1976:233)

A tribe is regarded as owning a definite tract of country, the boundaries of which are known to them and recognised by the members of other tribes.

Elkin (1938/70:56), while speaking of boundaries does however bring out the point that there are not always easily defined boundaries suggesting that,

tribal boundaries are usually clearly defined by natural features; sometimes there is a kind of no-man's land between the two tribes, and occasionally it is difficult to know to which tribe certain territory belongs, for the simple reason that it is of little value or interest so no one cares.

Tindale (1976:12-29) argues that not only did boundaries exist, between tribal groups, but that they were for the most part ecologically based. In his study he gives evidence that some boundaries can also be established around those areas which need specialised knowledge to exploit their resources. However it can also be argued that many, if not all of the boundaries he describes could be considered as places at the edge of significance for exploitation or of no significance to groups and which can then also be described in European terms as a boundary.

Keen (1978:48) speaks of an alternative set of reasons (other than irrelevancy) for people not going beyond the limits of their familiar territory. He indicates such things as the possibility of dangerous places, places that may cause sickness, unknown spiritual entities and the knowledge that some places have dangerous power because of ancestral beings and that,

Because of all these dangers and restrictions people will not stay in a strange country without friends to guide them, unless forced to do so. This means in effect that people only use the country of clans to which they are closely related, or of which they possess knowledge for other reasons.

These kinds of things then, form a type of limitation, not so much because there is a fixed delimitation of space, but because of having passed beyond familiar focal places and the possible proximity of non-familiar and hence potentially dangerous places, which are best avoided. This idea of a boundary being able to be established where you are entering another tribe's territory is similar to that spoken of by Tindale.

While the literature includes descriptions of boundaries of tribal areas which relate to changes in landform, soil or vegetation type (e.g. Tindale 1976, Peterson 1976, Mulvaney 1976, Flood 1976 and Williams 1986), there are also references to the normal irrelevance of boundaries and to the difficulty of establishing them.

Peterson (1971:225-7) has suggested that the Yolŋu from Mirrnatja do have the concept of boundary although he found it difficult to get them defined. However the concept he defines appears to be more one of exclusion or restriction in relation to significant sites than the actual marking of a boundary and appears to be relative rather than fixed. He says (p226) that,

Part of the reason for boundaries being ill defined is that they are of no importance in daily life. However the closer they pass to areas of ritual importance the better defined they become until the point is reached where they would meet the approval of a surveyor as at the Bidingal clan well. It is of interest that the Gidjingali boundary is at a point where it is implied, two ancestral heroes met, and therefore a place that may be of ritual importance

Thus the one boundary he records as absolutely fixed is actually a separation between two clan's focal places which are side by side. In his description this idea of separation by restriction rather than by fixed boundary becomes clearer when he suggests (p226) that, "The nearest to a specific term for boundary is lolo." He says that this word is used as the name for the resonating tin can or piece of bark put around the opening of a didgeridoo and also for European fences. He quotes Mrs N. Williams as supplying information that it is used also at a makarata peace making ceremony for the "closed circle of men that gathered around the murderer at the conclusion of the ceremony," where it also referred "to the ritual/legal

circumscriptions on the man". He reports that when the circle opened, the man was physically, legally and ritually free, whether he was stabbed in the thigh by an offended relative or not.

The word suggested here by Peterson is also the word used by the Yolŋu for gaol, and the name for and intertidal stone fish trap which restricts the escape of fish, making them easy to spear. In this use and in each of the uses he described, it would appear to refer to "restriction" (from or within) a meaning that partly overlaps the parameters of the meanings of the English word "boundary" but which is not exactly the same.

From his report, the nearest Peterson could find to a concept of boundary was this concept of restriction. There is in his report no clear evidence that anything like the Western notion of boundary existed in the Yolŋu approach to space and its use. Although as Keen (1978:47) says,

Some boundaries are clearly defined, such as the edge of a forest or the division between saltflat and grassplain. Other boundaries are less precise - perhaps just an imaginary line between two trees. Sometimes there is no defined boundary, simply one side of a forest is one 'place', and the other side is another. One type of terrain tends to predominate at each 'big-name' place, although many contain a mixed ecology.

My own experience in mapping areas with Yolŋu informants is that it is often a major effort to establish anything like a boundary, even between sites belonging to different moieties unless the site has a natural physical limit such as the bank of a river or the edge of a jungle. However even in these cases it is the river or the jungle which is of importance, not its edge. My observations appear also to agree exactly with those made by Hiatt. He records (1962:65, and 66) that among the Gidjingali (western neighbours of the Yolŋu) he found the same process of naming sites, with the absence of boundaries except where these coincided with a natural feature, apparently by coincidence as much as design, but supported to some degree by mythology.

My argument is not that boundaries cannot be established, but that the mode of establishing ownership, or which territory is owned, was not by boundary but by focus and that therefore any boundary involved was incidental not critical. It is proximity to sites of significance that is important, and who owned them, not who controlled the periphery or the less significant land at a distance from them. It is as Berndt (1976:134) reports for Western Desert people concerning the identification of sites, that as one moves from one site to the next,

the actual site name is expanded to blur with the next so that the country immediately surrounding any one site becomes identified with it. No clear-cut boundaries are recognised.

The "boundaries" recorded by Tindale and others are, according to this approach, established at what might be called the place of greatest irrelevance, beyond which there is "no value to us", using the term "value" from a Yolŋu perspective where value is seen in terms of intensity of relationship to the focus (see Figure 5.1)¹. That is, boundary is positioned at a place "beyond our place of value" in a ceremonial sense, and nearer to some other's place of value. Such "boundaries" as are applied to land are all related to ownership of ritually or spiritually significant places. While they serve to establish or rather reinforce rights in these places, they are not meant to exclude all other people. Williams (1986:83) has said that,

boundaries are, in general, only as precise as they need to be and they may be precise or imprecise for a number of reasons.

Nancy Williams argues however (1982 and 1986) that the Yolŋu at Yirrkala can and do demarcate precise boundaries when under pressure of one kind or another to delineate ownership of particular sites. In the terms of her description these reasons can be summed up as being in direct proportion

¹ See also Figure 1.1 and associated discussion.

to the closeness of relationships between adjacent land owning groups with more precise boundaries² reflecting poorer relations.

My suggestion is that it is not the normal practice to place any emphasis on demarcation except for political reasons of one kind or another, and that then if the dispute is between two groups, each will claim, and support with a variety of arguments, that the "boundary" is established in their favour. This is not an argument based so much on the movement of or establishment of boundaries, as an argument based on the establishment of relative significance and power of rival groups and their perceptions of their own importance and the relative importance of the sites. In my own observations, such claims appear to be more regularly voiced in the presence of non-competitors, in an attempt to build support for one's own claims.

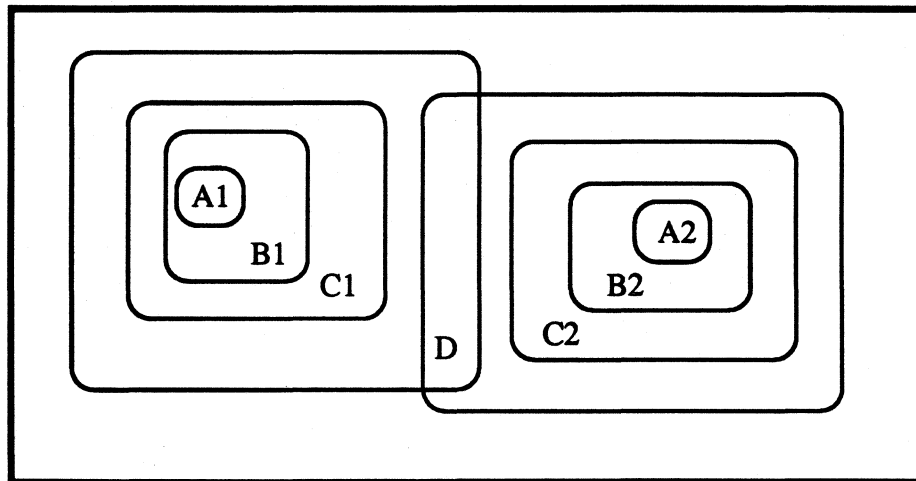

Code: A = Site Focus.
B = Land Relating Strongly to Focus.
C = Land Relating to focus.
D = Land relating loosely to focus and potentially the area of location for a restriction boundary between sites A1 and A2.

Figure 5.1. Relationships between focal points and adjacent land.

² Here too the concept of restriction, particularly of access, is more relevant than that of perimeter.

Where two groups have pressure put on them by an outside body, e.g. a government agency, to establish a "boundary" between their adjacent territories, this will be established as an expression of the relations between them, and afterwards ignored except in a dispute situation. This type of response is to be expected because it is the named site, and often a particular point within the named site which is significant. The surrounding named area then functions as a buffer around and an extension of that which is important.³

This system works for the Yolŋu; however they have discovered that in relations with the white man it doesn't and they have to translate their system to match his system to obtain satisfactory results in relation to him. A perfect example of the failure to appreciate the difference between the Yolŋu and Western approaches to identifying land is found in a sacred banyan tree that once was surrounded by jungle at the site of the Nabalco mine at Gove. The tree was designated as the sacred site and it was not argued that the jungle around it was important to it and part of the site. Therefore the mining company removed the surrounding jungle and at the last observation I made, the company was daily watering an isolated tree in the middle of a mining area. The Yolŋu in the Yirrkala area will not make that same mistake twice.

This Gove example gives an appreciation of the need for Yirrkala Yolŋu to establish very precise boundaries *against* the incursions of white miners at Gove. As a result of having their land under threat the Yirrkala people have become very articulate and well able to give precise boundaries to land, using in almost all the examples that Williams lists, some natural physical variation as an indication of a given boundary.

³ Unlike the Western concept where a piece of land defined by its boundary is generally thought of as all being of the same value.

Classifications of Space and the Naming of Sites.

The most obvious basis for the naming of geographic features of the land is the projection onto it of an anthropomorphic image. This results in the following list of terms for body parts being also terms for landscape features.

buku = forehead, headland.
magutji = eye, small waterhole,
ṅurru = nose, point
dhurrwara = mouth, river mouth
dhakal = cheek or island,
mayan = throat, creek or river,
diltji = back, the bush, back or hinterland country. Made up of open eucalyptus forest,
gulun = stomach, large water hole or swamp,
likan = elbow, river bend.
makarr-yindi = thigh-big, the mainland as contrasted to coastal islands,

Other ecological zones which are also distinguished but which have no apparent relation to body parts are

larrtha / gathul' = mangrove areas,
ninydjiya = tidal plain or salt pan,
raji / dhawada = sand, beach or exposed sand bar,
retja = variously described as jungle or monsoon forest
monuk = literally salt, the sea or salt water,
djiwarr' = the heavens, heaven, the sky or simply the above.

These two lists contain the major terms used to identify geographic features. Figure 5. 2. is drawn as a stylised landscape to make the anthropomorphic features of some of these terms more easily visible. As none of the terms in the second list are also used for body parts it cannot be suggested that the landscape is seen simply from an anthropomorphic perspective.

Those terms for the landscape features which are anthropomorphic have some distinct advantages when mythological interpretations are being applied to such aspects of the land. This can easily

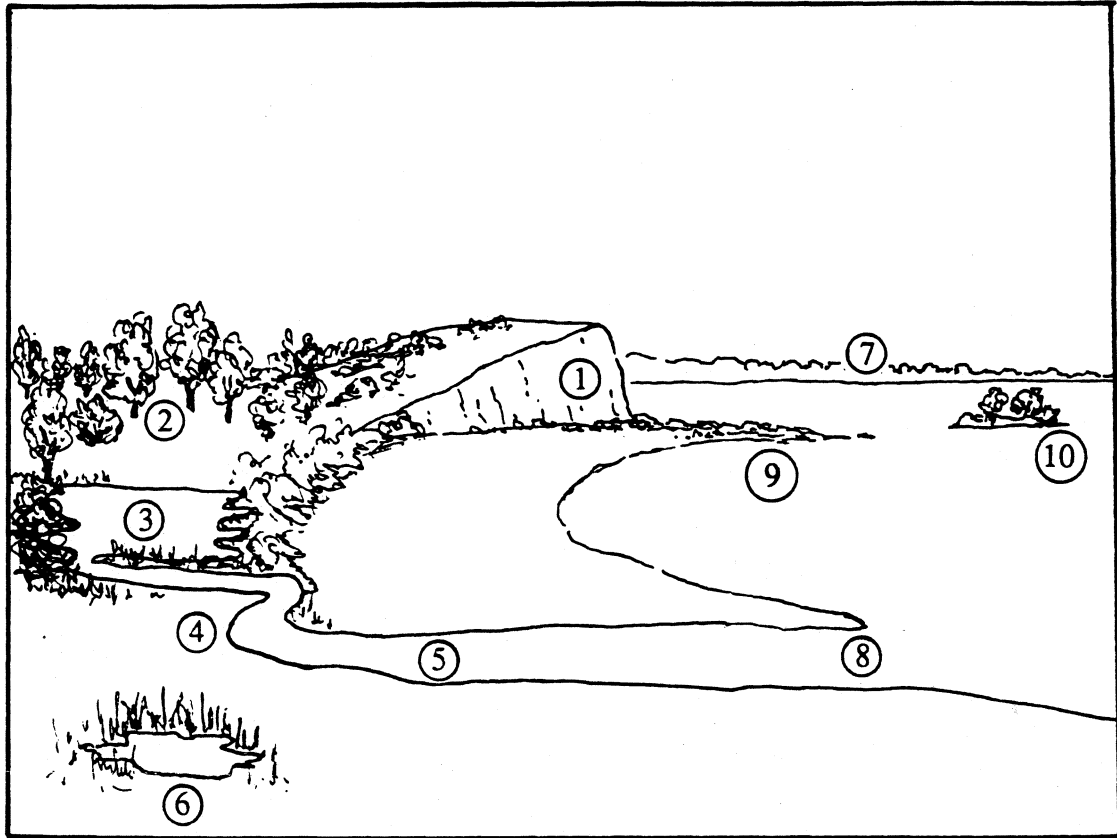

- Key.
1. *Buku* (forehead, headland)
 2. *Diltji* (Back, hinterland)
 3. *Gulun* (Belly, lagoon)
 4. *Likan* (elbow)
 5. *Mayaṅ* (throat, river)
 6. *Maṅutji* (eye, small waterhole)
 7. *Makarr yindi* (large thigh, mainland)
 8. *Dhurwara* (mouth, river mouth)
 9. *Ṇurru* (nose, point)
 10. *Dhakal* (cheek, island)

Figure 5.2. Anthropomorphic features of the landscape.

be recognised when we take as an example the shark site in the Wessel Islands which was partially described earlier in Chapter 2. At the south-eastern tip of Martjanba Island in the Wessels there is a bay that is several kilometres across (See Map 2.1). Approaching it across land from the West you come to the edge of a cliff that is fifty or sixty metres high and can look down on the whole panorama of the bay. A sandy beach swings away at first to the North-east and then in a long curve towards the South-east till it meets a long hill that juts out into the sea. Something like the bay drawn in Figure 2.2.

This entire site represented the transformation of the ancestral shark and particular features of the landscape were pointed out as parts of the shark's body. However without the knowledge that this is a shark site, one could hear a discussion of at least some of the landscape features, hear the normal reference to body part names, but not know that the discussion had nothing to do with the landscape.⁴

With the use of anthropomorphic projection onto the landscape, it would be possible with this site for a man to paint a picture of the shark as an ordinary shark, to be symbolically encoding a layer of meaning which talks about the sacred shark object or ranga, and still another representing features of the landscape that were associated with the shark ancestor.⁵ The advantage of using the anthropomorphic projection is then that the encoded meanings are able to be kept secret from those one desires to be kept in ignorance.⁶

⁴ In this case, the use of the normal body part terms for the landscape features enables reference to be made to the body parts of the ancestral being without revealing the additional meanings to the uninitiated.

⁵ Morphy (1983:123) in his description of Mangalili paintings from Djarrakpi demonstrates that notions of anthropomorphic features of the landscape are also found there in paintings representing the landscape in one level of interpretation.

⁶ It could be argued that this is an example of zoomorphic projection, but the principle is the same.

A totally different aspect of the naming of locations is that associated with the development of the names for particular places. Many places gain their names as a result of being named after some mythological or historical event. In a later section dealing with Dhambalaḡur I will show that it was on these bases that a number of the sites were named.⁷

Within the town of Galiwin'ku, there are a number of sites named on the basis of mythology, such as Nḡalkanḡur, the hospital site associated with the Barracoota, and Damala Yalu (lit.eagle's nest) next to it, where the water tanks now stand, where eagles reputedly nested in tall stringybark trees, but which also has mythological associations.

Many of the sites on the Elcho coastline (See Map 5.4.) have gained their names as a result of such mythological events. Some have alternative names which describe some aspect of the location. For example, the short beach at the end of the airstrip, which has a mythologically based name, *Gurrka-walpa* (lit. penis- ?) is commonly called Munatha gurriri (lit.sand short) or Munatha dhumbul (lit. sand short). There are also some sites which have been named as a result of a simple feature at the site such as at Riyalaḡur (lit.stream-at) the site of the freshwater spring which was the source of the town's water supply until the late 1960s, and Narraniḡur (lit. Wild apple tree-at) which refers to the most south-easterly residential area, where the first Yolḡu cottages were built near a narrani⁸ tree.

Finally there are in the town at least two sites named on a historical basis. Djalumbuḡur is the open area between the two Warramiri

⁷ For example, there is the rock and surrounding area called Nḡatili nhinan (lit. black cockatoo sat) where in mythological times the black cockatoo is reputed to have landed. The black cockatoo is associated with one of the sacred objects for the area so this site name also has potential for more than one interpretation.

⁸ *Syzygium suborbicularis*

areas, named because a *Djalumbu* (hollow log coffin) used to stand there. *Wulmanjur* (lit. thunder-at) sounds like a myth-based name, but it was given because it is the place where the Djambarrpuyngu Guyula live, and in particular where a senior ceremonial leader from the clan lived. Thunder being a major ceremonial element for that clan, they are identified by the name and from that so is the site. It could be said of both of these that while they are historically based there are also mythological links.

From this examination of the naming of sites it is possible to draw out what appears to be a simple set of principles by which such names are given. That is names are given on the basis of, anthropomorphic projection, mythological or historical events or associations (difficult to separate) and recognisable features, but they do not appear to be given the personal names of humans.

Distance, Location and Direction in Space.

The location of any object, person or event in space is indicated using a variety of methods, however it should be noted that in each of them the Yolŋu identify a specific location in space in terms of its relation to other locations, they do not measure the distance between locations. In addition to this, there are a number of other ways of indicating relationship to space. There are noun suffixes that indicate direction or location in relation to the noun, there is a set of deictic pronouns which identify relative proximity, and there are wind directions which are used for a variety of purposes. Each of these is outlined below.

Lowe (n.d.) lists a number of words which she describes as "pure adverbs of place"; (p.11), *djinaga* (inside), *warragul* (outside), *barrku* (far away), *galki* (close by) and *garrwar* (above/up top). Each of these

classifications is modified using one of the terms, *märr* (moderately) or *mirithirri* (intensely) to produce a series of three evaluations in each category. For example, *märr barrku* (moderately far away), *barrku* (far away) and *mirithirr barrku* (extremely far away), can be used to classify the locations of items that are not close.

In any use of these terms, the classification made is in relation to the context of that use. Because the context of use is variable, the meaning of each of the three terms in a set is relative, to each other term, and also to the context of its use. Each set of three terms describes a discrete quality or attribute of existence, and each is seen as being in relationship to its opposite, but as not forming part of a continuum with its opposite term. For example *galki* (close) and *barrku* (far away) used as evaluations of location in a more or less horizontal plane, are seen not as poles of a continuum, but as classificatorily distinct categories between which there is no continuum. They are also the terms which come nearest to any indication of distance from some location.

In addition to such terms for generalised location in space relative to the speaker, there are three suffixes which enable location or direction to be specified relative to any particular item or named place. These give yet another way of describing the location or movement of any person, animal or thing. For example, a person who is at or was at the *rañi* (beach) would be described in Gupapuyñu as *rañiñura* (*rañi* beach, *-ñura* at, in, by). Someone moving towards it is going *rañilili* (*-lili*, towards) and if going away from it they are going *rañiñuru* (*-ñuru*, from, away from).

While there are a number of deictic pronouns listed in Lowe (n.d.) there are only four discrete locations identified by them. These

Gupapuyŋu words, together with definitions of them given by different informants, are given in Table 5.1.

Pronoun	Informant	Definition
<i>dhuwala</i>	1. Matjapu	here, this
	2. Dopiya	here where can touch or reach
	3. Djandilŋa	this, here, closer to speaker, <i>galki</i> (close).
	4. Warrayak	<i>mirithirr galki</i> (very close)
<i>dhuwali</i>	1. Matjapu	a little bit away (ask someone else to get it)-proximity to someone else.
	2. Dopiya	there, behind something that is in between speaker and object.
	3. Djandilŋa	there, present in time but not in space, closer to audience, <i>märr galki</i> (moderately close) <i>barrku (märr)</i> , (far [just a bit])
	4. Warrayak	<i>märr galki</i> (moderately close)
<i>ŋunha</i>	1. Matjapu	can see but not close, maybe can't see but usually can, closeness but not too close.
	2. Dopiya	can be on the other side like at different place, or can be in sight.
	3. Djandilŋa	away from you, <i>märr barrku</i> (moderately far) or <i>märr galki</i> (moderately close).
	4. Warrayak	<i>barrku</i> (far) or <i>märr barrku</i> (moderately far).
<i>ŋunhi</i>	1. Matjapu	(no response recorded).
	2. Dopiya	long way
	3. Djandilŋa	present or absent in time <i>mirithirr barrku</i> (very far)
	4. Warrayak	<i>barrku mirithirr</i> (far very).

Table 5.1. Definitions of Deictic pronouns as given by four different people.

These definitions given in English, or in Yolŋu language in terms of nearness and farness, indicate two pairs of opposed terms with each term in a pair opposed to the other. All the locations are relative to each other, and each is relative to the speaker's position. They can be summarised as a pair of terms referring to locations that are relatively close to the speaker and a pair that refer to relatively distant locations. With the close ones there is contrast between whether a location is within reach of the speaker (or closer to the speaker than to the listener) and out of reach of the speaker (or closer

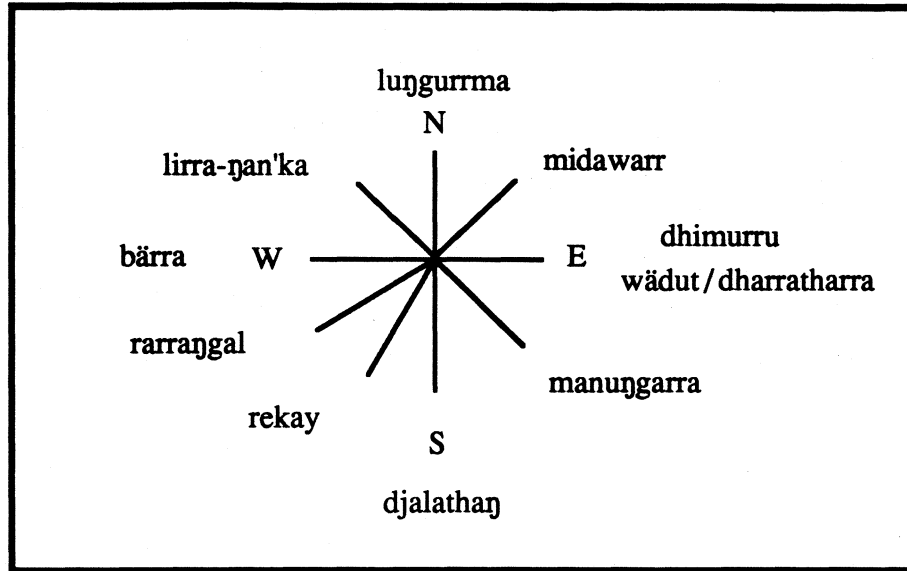

Figure 5.3. Compass and wind directions

to the listener). With the pronouns that refer to more distant locations there appears to be a contrast between locations that are either within sight (or at least closer than the horizon) and locations that are further away.

Directions are also given in what are commonly interpreted as “compass directions”⁹, but which appear to refer to the direction from which named winds blow at known times of the year.¹⁰ The set of terms used for this can apparently be used to indicate the direction of movement to or from given locations, as well as in relation to a speaker. They are used to describe the direction of a particular location (with the appropriate locational or directional suffix added), or the directions from which the wind is coming. During turtle hunting, these terms are used by the harpoon man, standing in the bow of the boat as he gives directions to the crew as to the position of the

⁹ There are some similar notions recorded in Thomson's 1942 notes although some of the terms he gives differ from those I was told.

¹⁰ See Chapter 6

turtle being stalked. These terms with their relation to the compass directions are given in Figure 5.3.¹¹

RELATIONSHIPS WITH SPACE.

Land and Identity

The land and the surrounding seas of the North East Arnhem Land region form the space in which the Yolŋu live. As Baḍaltja said (1980:10) the

"Land is a breathing place for the Yolŋu people."

That is, the land is where life exists, for the acts of moving and breathing (according to Yolŋu classifications) distinguish those things that are alive from those that are not.¹² Thus the land is also the place in which man's physical or outside manifestation exists. However, the land is far more to the Yolŋu than a breathing place. Djiniyini Gondarra (1980:8) describes a much closer relationship; that of actual kinship.

"The land is my mother. Like a human mother, the land gives us protection, enjoyment, and provides for our needs - economic, social and religious. We have a human relationship with the land: Mother - daughter, son. When the land is taken from us or destroyed, we feel hurt because we belong to the land and we are part of it."

Such human kinship relationships are part of the normal Yolŋu approach to land. As I have shown in Chapter 4, areas of land are seen to give women to be mothers for the children of other pieces of land. As a result of this a person is able to refer to himself as being in a kinship relationship to a number of sites. Thus the site that his mother came from is his *ḡāndi* (mother) and the site that her mother came from is *māri* (mother's

¹¹ While a general correlation can be made with compass directions, the south-west quadrant is divided according to perceived wind directions and these do not coincide with the continuous halving used in the Western compass.

¹² See Rudder 1983:141.

mother) to him. Major sites are thus also seen as being in a permanent kin relationship to each other. This relationship between sites can be represented as in Map 5.1. where the site at the source of each arrow is seen as being the mother for the site at its point. The site from which a man's father comes and hence also the site from which he comes, could be, but is not referred to as his father. Rather it is called his homeland or *Yirralka*. (See Map 5.2.).

Djalaŋgi, in a very brief statement encapsulates the significance to the Yolŋu of their homelands, when he says,

"Homeland is called *yirralka*. Identity comes from there. Yirralka tells you that you are Yolŋu. Without it you can't be Yolŋu. *Manikay* (song cycle) at *yirralka* is special and helps you know what you are."

"Some *maḍayin wāṅa* (sacred places), you can go there and you can get sick, but some are good places so long as you don't cut trees. A long time ago Raymaŋgirr was know as a place for boils, and when *balanda* (white men) were cutting poles for the wharf there, they all got boils. I only heard that story. It was when Sheppie was at Milingimbi."

The homeland is the focus of both the individual's and the clan's identity. The *maḍayin*, the sacred elements of the clan's identity, are predominantly related to the *yirralka*,¹³ and it is to the *yirralka* that at least some element of the deceased clan member is believed to return. It is a place that must be treated with the most absolute respect, and it is considered dangerous not to do so. An example of this danger is included in the quote, where it is emphasised that not even the white man could avoid the dangerous power there as evidenced by the boils that were seen to occur when they cut down trees at the Marraŋu clan's homeland site at Raymaŋgirr.

A person's identity cannot be fully explained except in terms of his relationship to the land and to particular parts of the land. This relationship is expressed in terms of the individual's identification with

¹³ See Peterson 1971:207

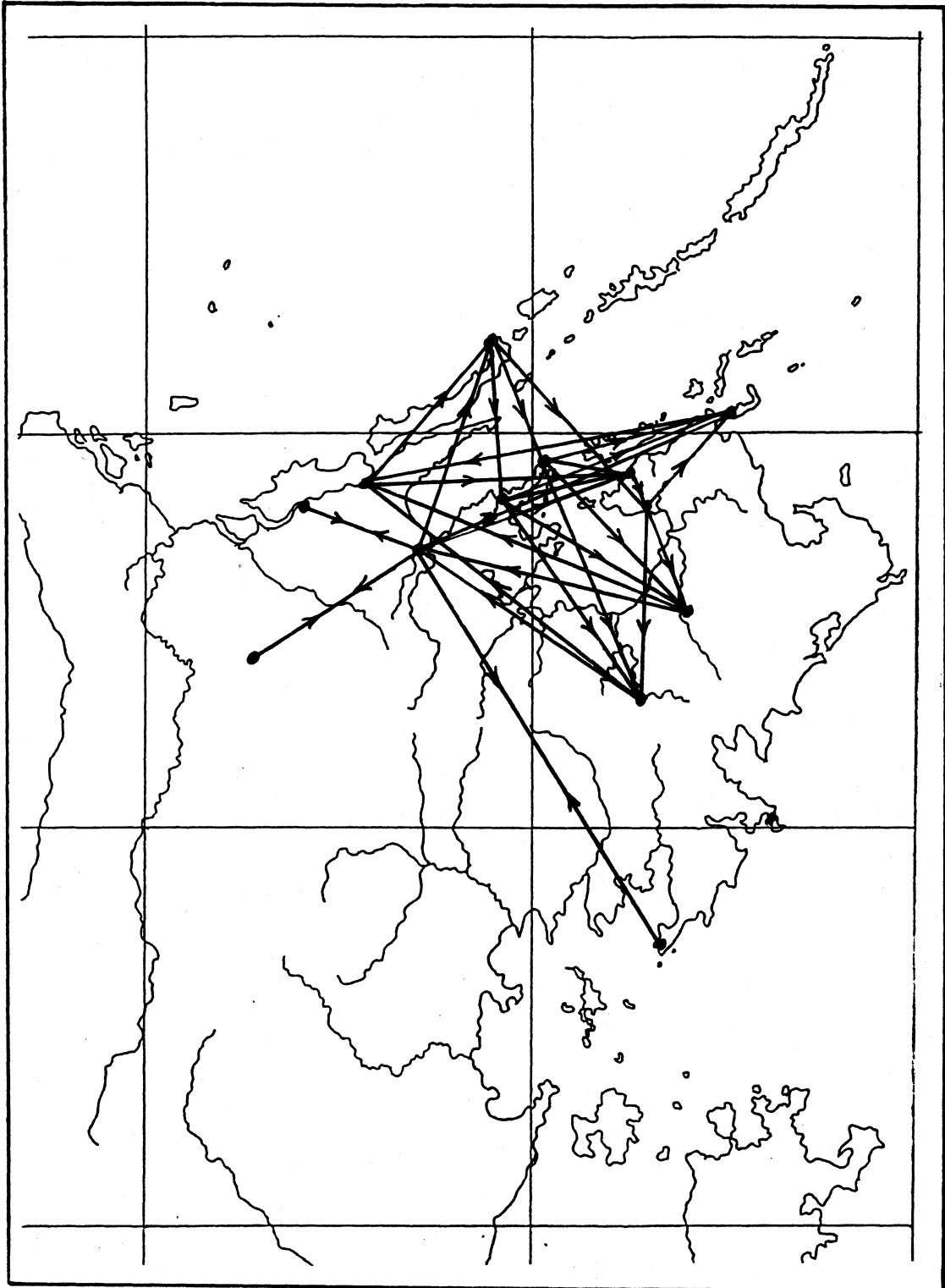

Map 5.1. Pattern of bestowal of women from one site to another, based on ideal marriage patterns. (See also Figure 4.10.)

sacred objects, designs and paintings which function as proof of the relationships between the person, the site and the actions of the foundational ancestors at the particular site as they moved from place to place through the region.

The homeland centre is just that, the centre of a tract of land which is the spiritual homeland for a patrilineal clan. It is the focus of the sections of mythology, which link it to many if not all of the other sites in a clan's territory. As such it is the focus also of the identity of the whole tract of land. Some clans have a number of such centres in a single region, some have only a single major site in theirs. Still others have two or more major sites with their associated territories scattered in different parts of Arnhem Land. I could find no consistent pattern which would explain all these variations and there is no certainty that all the major sites of any one clan will be linked by the activities of a single creative being or ancestor. Many, though not all of the major clan territories match the river basins that line the coast.¹⁴ Where this is so it is the river which is the focus of the territory's identity and not a boundary between it and the next river. Some major territories have no significant rivers at all, but it would appear that in every case a permanent fresh water source, if not being the central focus of the area, is closely related to it.

These *yirralka*, as far as record and mythology show, have always been the central fact of the clan's identity, but until quite recent historical times appear to have not been permanent places of residence. With the arrival of missionaries, attempts were made to teach the Yolŋu to grow food crops such as sweet potato, cassava, some other vegetables and fruit

¹⁴ See Peterson 1974.

trees. The idea behind this appears to have been to encourage people not to leave their land for the mission towns and at the same time to introduce what were then thought to be the skills and understandings needed for a civilised life. To do this the Yolŋu were encouraged to develop "outstations" on their own country. According to Shepherdson (1981), "The first outstation in Arnhem Land was established in 1936 at Gattji on the mainland ten miles south of Milingimbi". This appears to be the first recorded attempt of one of the Yolŋu establishing a permanent settlement on his own homeland. Other such "outstations" were slowly established in the eastern half of Arnhem Land. Right from the beginning the idea developed and was encouraged by Harold Shepherdson, that if an airstrip was cut and cleared, it was possible to get the desired Western items in exchange for such items as crocodile skins, and still remain in their own country.¹⁵ When the export of such skins was banned the only alternative became the development of the craft industry.

From the mid 1960s, a wave of newer settlements,¹⁶ began to be developed, as mining interests appeared on the scene and the land itself came under threat. As much to protect their homeland centres from attack as for any other reason, people began to establish permanent homes there. Those that I was able to identify with some degree of accuracy are shown on the map and the ones serviced from Elcho are listed in Table 5.2¹⁷, together with the relationship between clan ownership, the leader of each centre, and the land it is on. When this is examined, it is found that eighteen are on their own country, three are on *nāndi* (mother's) country, four are on *māri* (mother's mother's) country, two are on country for which their clan is

¹⁵ See Peterson 1971.

¹⁶ Called homeland centres at Galiwin'ku.

¹⁷ This table is a listing of the facts as given by one man. Some of the ownership was given in a rather general sense. e.g. The broad use of the terms Gupapuyŋu and Djambarrpuyŋu. He seemed to be more focussing on the person acting as leader and on his relationship to the land.

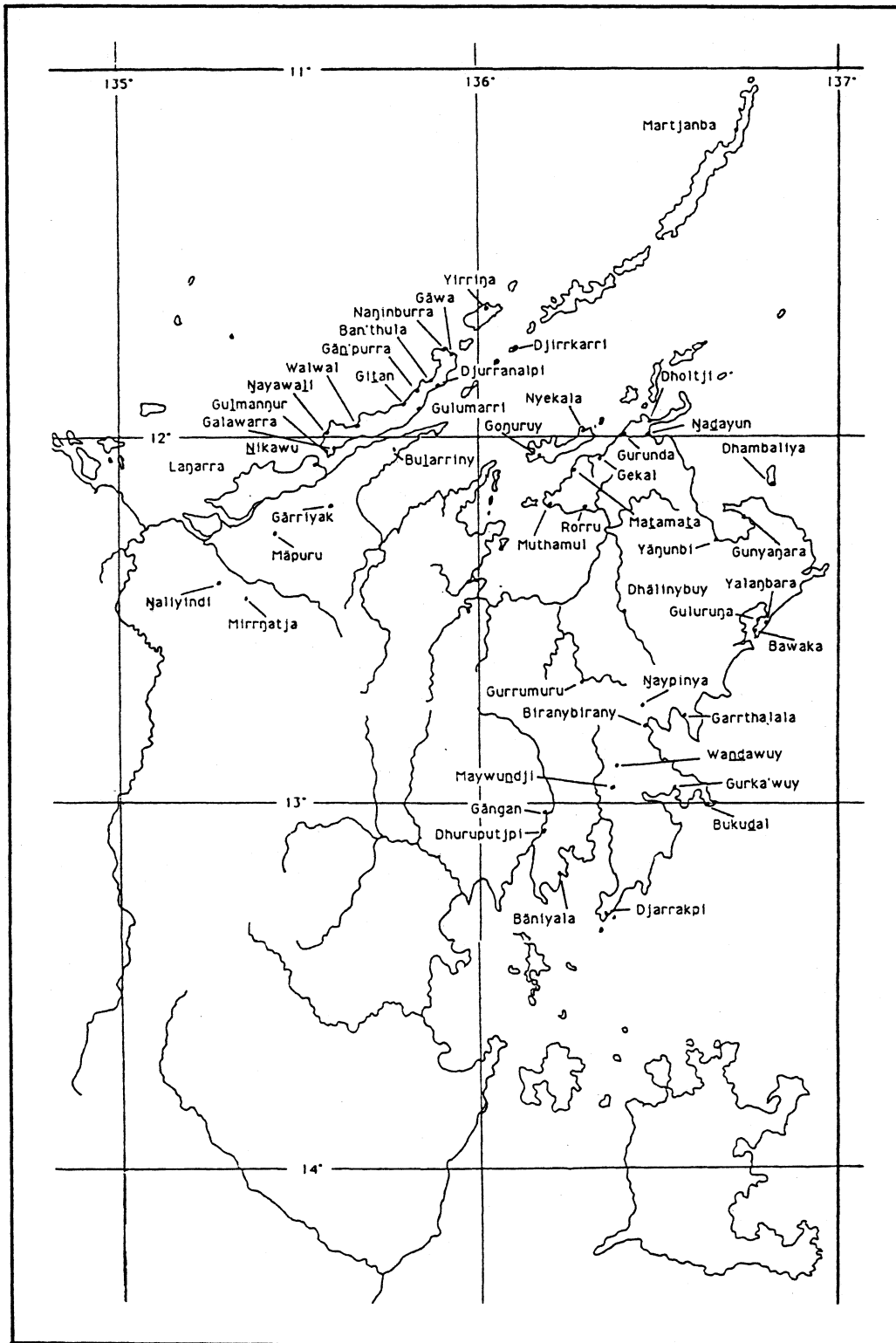

Map 5.2. Some Outstation/Homeland Centres in North East Arnhem Land

mother and one is on country which has the same *madayin* (sacred objects) as his own. Finally there is one Thursday Island man who has settled with his wife on her country, making it his children's mother's country. While only one of the eighteen listed above as settling on their own country could be considered as an "old" man, none of the others are young men. In all cases the leader for the centre is close kin for the land. I did not have opportunity to investigate further reasons for the ten who were developing centres to which they were related through their matriline, but there does seem to be good support for Peterson's suggestion in general statistical terms (1974:24) that there is a,

cultural value that makes adult men increasingly keen to live on their own clan estate, not only because they are always at hand to participate in their own clan ceremonies, but because they wish to die there.

At Galiwin'ku there are however some elderly and very senior men who have chosen to live in the town itself. In the majority of cases, this is for medical reasons. Most of them are on continuous treatment through the local hospital and it would appear that for most of them the assurance of treatment and of staying alive is an even greater motivation than the attraction of the homeland.¹⁸ One very senior man from the Liya-gawumirr clan had tried to live on his homeland, but nearly died of a severe asthma attack. As a result he chose to stay where he could get prompt medical attention. If such facilities were available at their homelands, there is little doubt that that is where the majority would prefer to be living. There is a strong motivation to protect the country from the intrusion of white men (particularly miners) to protect the particular lineage's claim to the site and the ownership of the *madayin* (sacred elements) that belong there. Each centre functions as I have

¹⁸ Compare Peterson (1971:336).

Marthakal Outstations				
Map Outstation Ref Name	Area Ownership	Clan Building	Leader	Country is
1 Martjanba	Gandaṇu	Gandaṇu	Barripaṇ	Own
2 Yirriṇa	Warramiri	Warramiri	Dhokuṇ	Own
3 Naninburra	Rongaṇu,	Gupapuyṇu	Galaṇ'kalwuy	His māri & gāthu
4 Gäwa	Warramiri	Warramiri	Murriritj, Läpa.	Own
5 Ban'thula	Djambarrpuyṇu	Djambarrpuyṇu	Gämbika	Own
6 Gän'purra	Gupapuyṇu	Gälpu	Yalkarriwuy	
7 Giṭan	Gupapuyṇu	Gupapuyṇu	Beta and Gambuṇ	Own
8 Bularriny	Gupapuyṇu Guyamirrilil	Djambarrpuyṇu- Nininyṇu	Manyguluma	Son
9 Gulmanṇur	Liya-galawu- mirr	Liya-galawu- mirr	Datjarrana	His mother
10 Nikawu	Gupapuyṇu- Birkili	Gupapuyṇu	Mapilarri	Own
11 Mäpuru	Gupapuyṇu- Guyamirrilil	Gupapuyṇu- Guyamirrilil	Galṇdhuna	Own
12 Mirrṇatja	Djambarrpuyṇu- Dhālinymirr	Djambarrpuyṇu- Dhālinymirr	Māṇay	Son
13 Naliyindi			Djipuru	
14 Gulumurru	Gandaṇu	Golpa	Djarrka & Dhalṇanda	Their mother
15 Djurranalpi	Djambarrpuyṇu	Gumatj	Bapulu	His ṇāndi and waku
16 Djirrkari	Bararrṇu	Dhalwaṇu	Belu	His waku
17 Goṇuruy	Djambarrpuyṇu		Freddy Atu	His wife's
18 Muthamul	Wangurri	Wangurri	Buthimaṇ	Own
19 Rorru	Dätiwuy	Dätiwuy	Muwarra & Manydjarri	Own
20 Matamata	Warramiri	Gumatj	Djäti & Mattjuwi	Their māri
21 Gekal	Gälpu	Gälpu	Mandjuwi	Own
22 Nyekala	Warramiri	Warramiri	Wulanybumal	Own
23 Gurunda	Gumatj	Gumatj	Walunba	Own
24 Dholtji	Warramiri	Warramiri	Liwukaṇ	Own
25 Naḍayun / Gurka'wuy 2	Golumala	Golumala	Balṇu	Own
26 Gäriyak	Liya gawu- mirr	Guyula Djambarrpuyṇu	Marapaywuy	Same name and totem
27 Walwal	Deceased	Liya-gawumirr	Djilipa	
28 Naṇawali	Gunbirri	Djambarrpuyṇu	Guruwanawuy	His māri
29 Dhäyiri	Gunbirri	Djambarrpuyṇu	Galṇadi'wuy	His māri
30 Ganapurra (part of Ban'tula)	Djambarrpuyṇu	Women's group	Dayṇumbu helping them	
31 Galawarra	Gandaṇu	Gandaṇu	Mununṇu	Own

Table 5.2. Outstations/Homeland Centres in North East Arnhem Land.

indicated above, as the focus of the identity of the geographic region, but also at a different level as the focus of identity of the owning clans and individuals.

The Yolŋu mythology features innumerable journeys by what appear to be ancestors or ancestral beings from one homeland centre to another.¹⁹ The number of stories and variations of stories appears to be endless. As has been shown some of the beings are considered to be of far greater significance than others, and there is a correlation between the importance of any one being and the number of different clans and clan territories linked by that being's journeys.

The journeys and actions of these ancestral beings are treated as the basis for the relationships which exist between the sites and hence the clans. The two moieties have completely separate sets of beings, each ancestor being careful to travel only in country of the same moiety as itself. Where a myth describes the passage from one area to the next it may be described as going inside in one and coming out in the next, as going over or under, but not carrying out any actions on land which is of the opposite moiety.²⁰

I have made an attempt to outline the journeys of some of the ancestral beings on the map of Yolŋu territory (see Map 5.3). This is simply to illustrate the ways in which their journeys link the major homeland centres of the different clans. While it is only a minute sample it shows that a network of linked sites is formed which mirrors the relationships established

¹⁹ At this point I am only concerned with the networking of their journeys across the landscape having discussed the nature of the beings more fully and outlined the three major myths in Chapter 2.

²⁰ Berndt, Keen, Morphy and Warner and others record such details.

between the clans who own those sites. In every case, the concepts involved are of interlinked focal places, rather than of connected, bounded territories.

Because of the interweaving of these journeys, each major site can be seen as linked with a wide range of ancestral beings. Through this the sites form the focus of two separate aspects of the clan's and hence the individual's identity. First there are the outward links to other clans that form part of their identity as members of the wider Yolŋu community. Secondly the unique combination of ancestors and their activities at any one clan's set of sites provides means for distinguishing the discrete nature of the associated clan's identity from all other clans.²¹

Elcho Island.

Elcho Island is spoken of by the Yolŋu as a kind of midway place between the people who live to the east and those who live to the west. The island itself, roughly 65 kilometres long and from 3 to 12 km wide, lies in a string of islands in a generally north east to south west direction, being at its closest point approximately two kilometres from the mainland.

Ecologically, apart from the complete absence of any significant elevation, the island can be thought of as representative of Arnhem Land generally²². The basic cover over the land is open Eucalyptus forest, broken by intermittent dry rainforest. The eastern coastline is dominated by an almost continuous mangrove fringe broken only by an occasional short beach. The western coastline is predominantly a series of sandy beaches separated by low rocky headlands and a series of tidal creeks supporting

²¹ As I have shown in Chapter 4

²² This generalisation does not take into consideration the vast Arafura swamp region described by Peterson (1971). The other features described here while not including any major rivers, are repeated consistently right around the Arnhem Land coast.

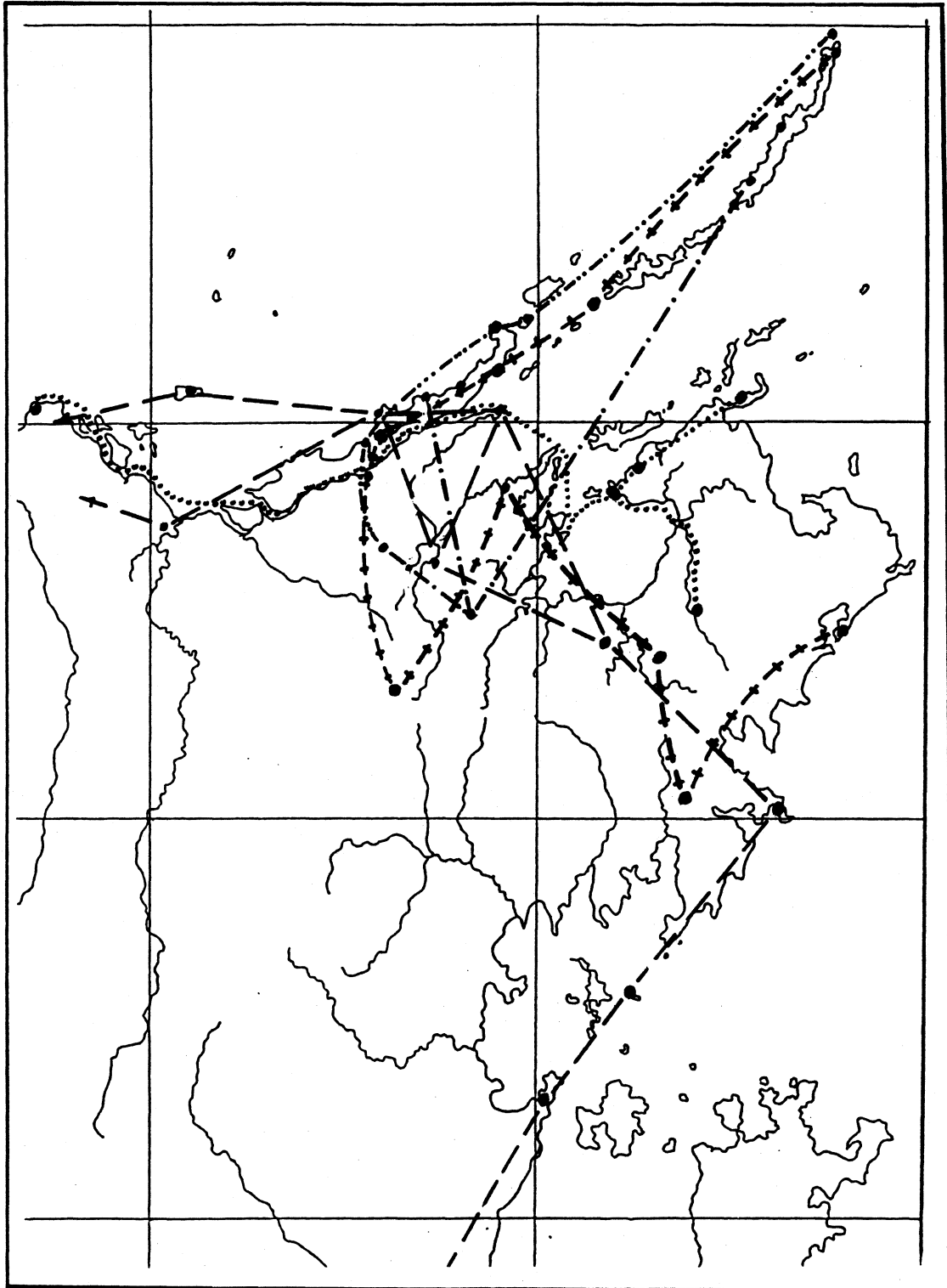

Map 5.3. Some connections between sites made by the journeys of ancestral beings.

mangrove areas. Along the island there are occasional swampy areas, some of which are supported by relatively permanent fresh water. The best original source of permanent fresh water was the spring at the base of the cliffs where the mission settlement was established. This has now been replaced by a permanent supply of good bore water and a programme has been established to sink bores at all the homeland centres.

The island is classified into sections of land (including the adjacent sea) which belong to one or the other of the two named moieties. If a continuous journey is made around the coastline, it is discovered that most features are named with territory adjacent to each being given the same name as the feature. This is so whether the feature is a rock, a waterhole, a sand dune, beach or river, so there is no relationship between the sizes of different named areas apart from the size of the feature from which the area is named.

If the hypothetical journey along the coast continues, eventually the last named site belonging to one moiety (for example Yirritja) is reached. The next set of sites will belong to the Dhuwa moiety. When the last of these Dhuwa sites has been reached, the next site will then be Yirritja again. This alternation of groups of sites belonging to opposite moieties continues right round the coastline until the original starting place has been reached.

Periodically there is a brief intrusion of an isolated site or two belonging to the opposite moiety where some mythological incident occurred due to the actions of an ancestor or ancestral being of the same moiety as the intrusive site. In following this process around different sections of Elcho Island I have only found clear boundaries where the named feature has a natural limit to its extension, such as the edge of a named "jungle" (the local name for a section of dry rainforest). Even then it is normal for large tracts of adjacent open Eucalyptus forest of indeterminate area to be given the same

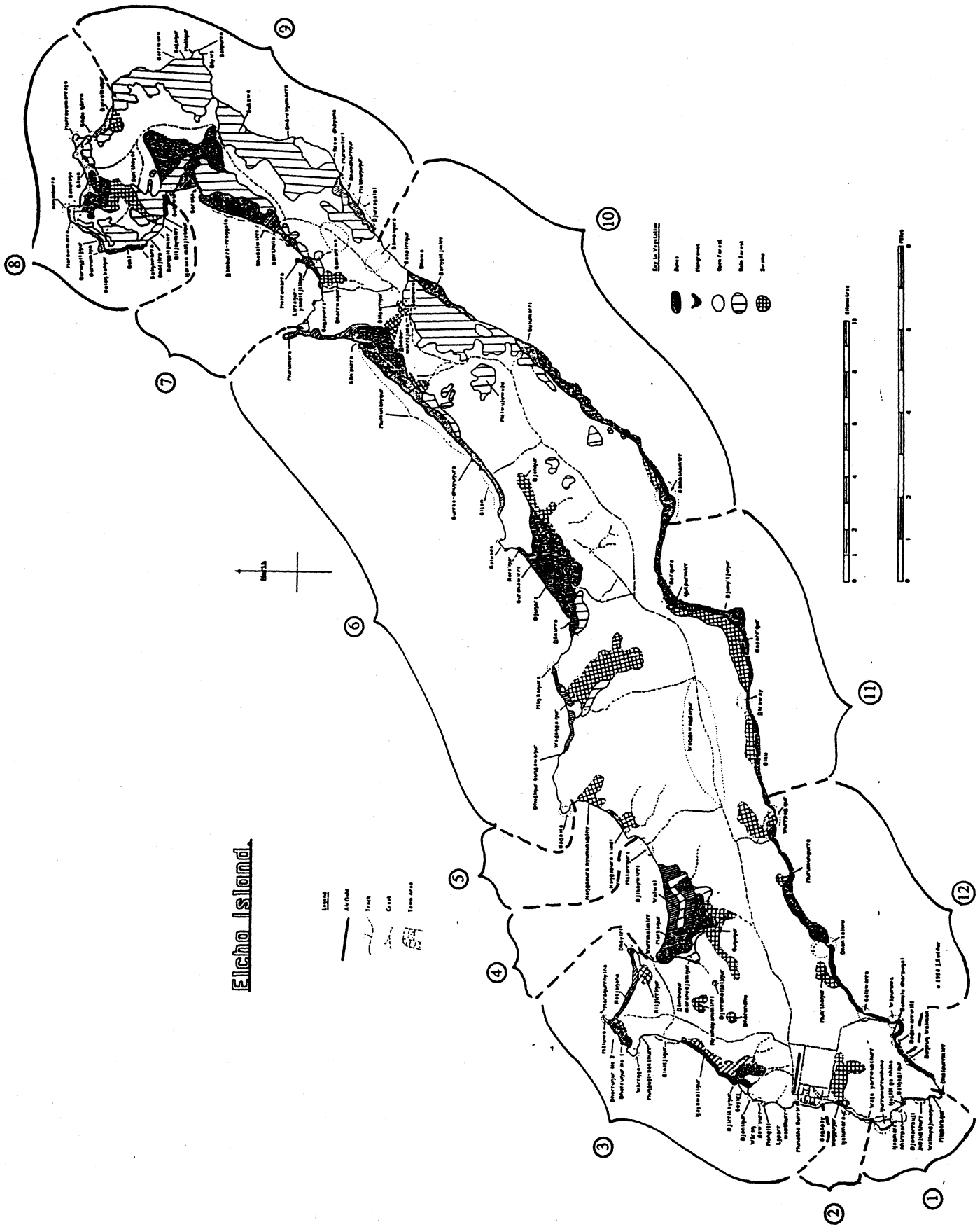

Map 5.4. Elcho Island. Major moiety divisions. (Distribution of vegetation after Dunlop et al 1975).

name as the nearest precisely named area whether that be a rock, a jungle, a swampy area or even a long beach. This agrees with the notions of focus outlined earlier in this chapter. Map 5.4, illustrates the major moiety divisions of the land on Elcho Island. The "boundaries" drawn on the map are simply lines drawn between the last named sites of each moiety, or drawn around groups of sites belonging to one moiety, and should not be considered as precise edges.

Of the larger areas, some are undisputedly acknowledged as belonging to a single group. For other areas, different informants give different responses as to who are the owning groups. Some are "owned" by groups of clans, with the priority of ownership disputed, some are argued to be in the process of being "looked after" by one group or another, and there is one area, for which the clan has died out and one man has been acknowledged as "owning" it on the basis that his father discovered him as dugong at that site before conception.²³

Berndt (1976) published a map of Elcho drawn from sketches made by Elcho men in 1968 which as he says were not drawn to scale. Some very interesting points become apparent when this map is compared with my own records shown in Map 5.4.²⁴ Firstly there are some sections of Berndt's map which are recorded in great detail with an expansive use of map space,²⁵ while others were skimmed over with minimum detail. However, while there is general agreement between the two maps as far as the allocation of sites to moieties is concerned, there is one Dhuwa section of the coastline which was completely omitted on the map drawn for Berndt.

²³ See Rrurrambu's story of his coming to his father in Chapter 3.

²⁴ The spelling of names on Map 5.4. is in the practical orthography used throughout Arnhem Land. The spelling Berndt used was in his own phonetic alphabet which does not represent all the sounds distinguished by the Yolŋu

²⁵ Sites 82-105 on Berndt's map are in the area covered by my Map 5.5.

The very full description given to some sections of the coast would appear to indicate that the original artists were focussing on land in which they were asserting rights and to which they were giving importance.²⁶

Finally there are some major sections of the south east coast²⁷ where there appears to be a difference among the Yolŋu as to which sites belong to which moieties (especially the Berndt sites 125-136). There is a difference between the moiety attributions recorded in 1968 and in 1990 for some of the sites. There are also some sites along this stretch of coast which were said by some of my informants to be Dhuwa while others said they were Yirritja. Whether this confusion arose from poor recording or poor communication, or whether there actually is a disagreement amongst the Yolŋu over the ownership of these sites, I am not currently able to discern.

There is a distinction made between those who have ownership of sites and those who have rights in sites. The owners are considered to be the ones who own the appropriate sacred objects for the site. As one of the younger ceremonial men, Djangirrawuy, said to me,

Land owners are the *wajarr wataŋu* (custodians of the sacred beings). They are the *maḏayin* (sacred elements) owners, owners of sites and objects. He who owns the objects owns the land or area of land. In each area of land there are a number of major places. Like in this place, the town area, the *ratjpa* (iron ore rock) is Gunbirri *ŋaraka* (lit. core or bones).

This place is Gunbirri, but Golumala entitled because *walalangu likan dhuwal* (their sacred connection here). The original foundation (*luku*) is Gunbirri. Naymil has *bundurr* (sacred names) and *likan* here so they have rights. Garrawurra (*Liya-gawumirr* clan's surname), *Liya-galawumirr*, *Liya-dhalinymirr* [Djambarrpuyŋu] and Birritjama (*bäpurru*) also have *likan* and *bundurr*. Warrukay songs travel as far as

²⁶ This being so it is possible to see that the Yolŋu men involved were using the occasion of the drawing of maps for Berndt as a political activity in which, while acting as informants, they were seeking to use the Anthropologist in the pursuit of their own interests.

²⁷ Recognising that the island lies in a north east to south west line, the arrow indicating north of the Berndt map is actually pointing to the west.

the other country in both directions. From Gunbirri to Mälarra and also from Mälarra to Gunbirri.

Golumala have the same *madayin* (sacred elements). They still come in and announcing here this place.

In pursuing this distinction between ownership and rights, he gave an example from his own country at Lake Evella and then returned to discussing the situation at Elcho.

I came from Lungutja, Lake Evella. The bird called *burala* (cormorant) came to Lake Evella when it was flat dry land there and he established the lake (dug it with his wing). He was Dhalwaṅu from Gangan. *Dhāruk ṅayi* (Language he) change to Gupapuyṅu and *bāpurru* (here = sacred names)- everything automatically changed because he was in a different land with different languages. Then he died there. That means *ṅaraka*, his bones are our *madayin* (sacred elements). His arm was caught in the *biyiwiya* (reeds). He hit Yāthalamarra with the other arm and then tried but stuck with two arms.

[Those others] Can pretend to look like, but can't create an object. They could copy, but can't make the real thing. It's their bird but they can only sing. They can't create the object.

It's like that at Elcho. They can claim, but they can't make the sacred object. They can create, but have to get authority from the *waṅarr waṅaru*. (custodians of the sacred beings) They can claim the journey and establishment and settlement, but they can't claim the *raṅga* (sacred objects), because it belongs to someone. It's [Galiwin'ku town site is] actually my own father's mother's country so he is the one who owns the *raṅga* (sacred objects). Its Dhuwa but they are all gone so even though he's Yirritja, he owns it. His mother and uncle are gone. That's the reason. That's the Yolṅu way of legal, unless someone of Dhuwa [moiety] had learned from my father *madayin'ku* (about the sacred elements). If they don't know the patterns and objects, they got no say.

Djiniyini's father's pattern may be the same or similar. That would give some patterns and part ownership of his father's establishment here *ṅunhi ṅayi bunan* (when he arrived) here, sent by Djupandawuy's mother's father and sister. He was a brother to Buthan and Mulupu and Munukarri [the last three Gunbirrtji people resident on Elcho]. The reason he came was that he was requested, plus they wanted him to look after the *madayin* (sacred elements). He grew up at Milingimbi and was a chosen man to come here from Gunbirri and Mälarra.

From this it would appear that this man is claiming that authority over land, including ownership is related to control of experiential knowledge of the *raṅga* (sacred elements) associated with a particular place. However in the case of the Galiwin'ku township he is going beyond the normal moiety bounds and claiming that his own father has ownership rights

in spite of belonging to the opposite moiety. In this his argument is based on the fact that his father's mother was one of the last two Gunbirrtji clan members on Elcho. This was the only example I found of such a strong claim being made on a matrilineal and cross-moiety basis, although a man as *waku* (woman's child) does have the responsibility of caring for his mother's clan's sacred objects²⁸.

In contrast to these claims, I should note here that there is a younger man from a section of the Gunbirrtji at Milingimbi, who has moved to Galiwin'ku. This man is being cultivated by some members of the Gundapuy Djambarrpuyngu clan as the person with the real ownership rights in the town site.

Virtually all ethnographic accounts of Yolngu society mention in some way, and with varying degrees of documentation, the mythological basis and support for the ownership of precisely defined land by particular groups of Yolngu.²⁹ There are also rights to the use of land which may be based on historic or economic use. As Williams (1986: 18) suggests:

For Yolngu as well as other Aborigines, the charter that establishes and validates all categories of rights in land is first of all religious. It is also historic. Thus for example, Yolngu may use past residence as an argument for continued residence or even stronger rights of tenure, along with or even instead of a founding myth. The charter is also economic. But for Yolngu 'religious', 'historic', and 'economic' are not mutually exclusive categories; they are complementary and reinforcing modes of perceiving and using land and natural resources (cf R. Berndt 1964:265, Berndt and Berndt 1977:95). The charter ultimately provides the lexicon for continuity in relationship to the land.

From my own contact with the Yolngu, it appears to be as Williams argues, that in the vast majority of cases, a mythological basis is

²⁸ Several men of the informant's Gupapuyngu clan have married women from Golumala clan. Their children will thus inherit strengthened rights as these come from both matriline and patriline, in spite of carrying these rights matrilineally.

²⁹ Among such writers are; Warner, Thomson, Berndt, and Berndt, Morphy, Keen, Peterson and Williams, but there are many others and an extended list is pointless here.

given for land ownership. While she suggests that there are historic and economic arguments that can take precedence over the religious, or mythologically based ones, it would appear from the literature, and my experience, that such bases for argument, where used, are likely to be linked to a mythological content.

There are a number of named sites with significance around the Galiwin'ku township, but to the south of the town along the island's coast is an area of much greater importance. This area is named Dhambalaŋur.³⁰ An examination of some details associated with this area will serve to further illustrate Yolŋu understandings of space.

Dhambalaŋur.

Dhambalaŋur (See Map 5.5), the section of land in the south western corner of Elcho Island, is one of the sites visited by the Djaŋ'kawu sisters in their travels. It occupies approximately four kilometres of the coastline and features a number of distinctive rocky outcrops of eroded multicoloured sandstone, many of which are understood to be transformations of one kind or another that are a result of the Djaŋ'kawu visitation. The area includes all the named sites shown on the map from Nurruwurrunhana to Bärraŋura, and photographs of two of them are included here as Plates 5.1, and 5.2.

When the Djaŋ'kawu Sisters arrived here they came from a Liya-gawumirr clan site on the mainland at Gärriyakŋur. When they came they brought with them in their bark canoe many *raŋga* (secret/sacred object)

³⁰ Section 1 of Map 5.4.

carried in their *ṅanmarra* (conical woven mats with fringes on them). I was told two different versions of their arrival. The first was as follows,

The Djaṅ'kawu came in a canoe called Guluwuru. They were Dhalkurrṅawuy and Barratawuy who came in the canoe, but also there were those two here, Guḍurrkuṭurr and Ganyitiṅu." He said of these latter, "Don't know if male or female. They take the one stone, it was already there. Munukarri, Golwa, Mulupu, Gunbirri [three Gunbirri clan members]³¹ were here when they arrived. The Djaṅ'kawu *gulṅiyinan* Minbirkṅur (went 'inside' at Minbirkṅur). The Djaṅ'kawu made all fresh water holes there *dhonay* (with digging sticks).

This description includes the names of at least two people who were alive in the 1940s when the mission was founded, so apart from an earlier set of people with the same names, would date the Djaṅ'kawu arrival in the 1920s to 1930s. According to two other men talking together and naming people who may have been dead before the mission or may have been attributed ancestors, including one, Ganyitiṅu, named in the first version,

The two Djaṅ'kawu came ashore at Galṅadi'ṅur. They met two ancestors there called Gurrulkurrul and Ganyitiṅu. They were [members of the] Gunbirri [clan]. The two [Djaṅ'kawu] sisters sailed from Gāriyakṅur to there. The two locals started to sing songs. Djaṅ'kawu heard the songs and said, '*ṅarraku balany bili*'. (Mine are just the same). So the songs came *dhipuṅuru ṅuruṅunyidja* (from here first). The two Gunbirri sang with *bilma* (clapsticks) and *ganydjarryu* (with power, or powerfully). After that the *bilma* were left there.

In the early 1970s, one of these clapsticks was given as a gift to the church by the *Liya-gawumirr* clan and cemented into the front wall of the church building. Bunbatjun says that he has seen a number of these stones uncovered by cyclonic storms which move the sand cover from the beach. Two of them are now set up in a small clearing right beside the track down to the beach at Bārraṅur with the top half of each (about 30 to 40 cm) exposed. (see Plate 5.2).

³¹ These three names were on another occasion given as the names for the last three Gunbirri clan members on Elcho.

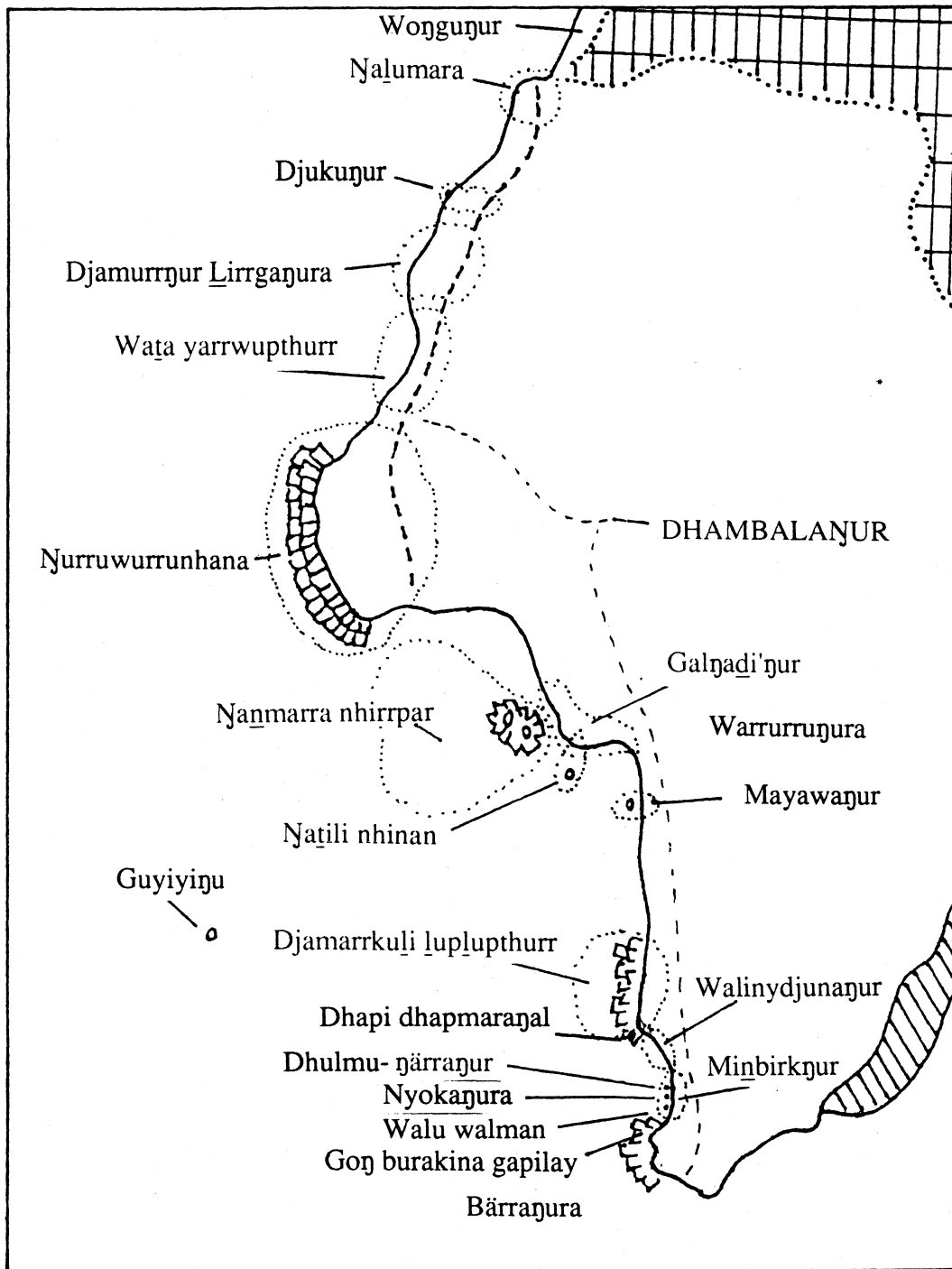

Map 5.5. Djaŋ'kawu sites at Dhambalaŋur

On a different occasion I was told that the Djaŋ'kawu were met by the man Garrawurra³² of the Liya-gawumirr when they came ashore at Galŋadi'ŋur. Two different free standing rocks, each about five metres tall, were said to be transformations of this man. One of these is in the midst of the rocks at Dhapi Dhapmaram, and the other as the most prominent of the free standing rocks at Minbirkŋur. (See Plate 5.1).

At Galŋadi'ŋur, "There is white clay inside that is not for use at any time. *Nāthil gan usim* [Someone used it before], but got killed." Further along the beach are some conical rocks which were identified as the Djaŋ'kawu *ŋanmarra* (conical mats) that had been used to carry the sacred objects. These were slightly south of the point shown on the map as Djamarrkuli luplupthurr (lit. the children swam) and a separate site from the one identified on the map as *Ŋanmarra nhirpar* (lit. the mats were put).

Djilipa and Bunbatjun said that,

"The local two (Gunbirri) gave to Djaŋ'kawu (their māri [M.M.B.])³³ saying, 'I give authority and responsibility to you, *manikay* (songs), *maḍayin* (sacred things), land'. They gave the springs of *gapu* (water) and names of places. The Djaŋ'kawu were Liya-gawumirri when they came here so now all is Liya-gawumirr. They identified with Liya-gawumirr like you, [me the anthropologist], are identified with Riratjŋu [The clan into which I was first adopted]. All the secrets from Gāriyakŋur [the Liya-gawumirr clan's homeland centre], *bathi* (sacred basket), *ŋanybak* (ceremonial arm bands), and *yākumirriyaŋal* (putting of names), all the named places at Dhambalaŋur, were given by Djaŋ'kawu. The names came from Gāriyakŋur to here. Walinydjunaŋur (Walinyuna) is the name of a place there and here".

Much of the Djaŋ'kawu activity was focussed at the short section of coast named Minbirkŋur.³⁴ Towards the southern end of this area is the

³² Garrawurra is now the name adopted as surname by the Liya-gawumirr clan.

³³ The name Djaŋ'kawu as used here refers to both the "creative ancestors" and to their transformation in the form of the Liya-gawumirr men who have brought the cult to the local site.

³⁴ There are several other variations of the name Minbirkŋur such as Minbirrkŋur and Minbirrkmirriŋur.



Plate 5.1. Djaŋ'kawu site, Dhulmu Njorra, at Minbirrkmirriŋur.



Plate.5.2. Djaŋ'kawu clapsticks at Dhambalaŋur.

When the Djaŋ'kawu sisters came ashore at Galpaḍi'ŋur, they met two Gunbirri women there named, Gurrulkurrul and Ganyitiŋu..

The two Gunbirri sang with bilma (clapsticks) and ganydjarryu (with power).

The Djaŋ'kawu heard them and said, 'Narraku balanya bili' (Mine are the same). After that the clapsticks were left there.

site known as Goṅ burakina gapilay (lit. hand pierced by *gapila*) where the Djaṅ'kawu women had their hands pierced by the fish name *gapila* (possibly a catfish).

Slightly closer to the centre of Minbirkṅur is a *walu* (sun) site which is a series of multi-coloured boulders which spread across the sandy beach from the bush to below the high tide mark. This site is invariably named as some variation of the sun's activity such as Walu walman (lit. the sun came out) or Walu ga dhärra (lit. the sun is standing). I was told that,

Walu is Ṇaymil, Dätiwuy, and Liya-gawumirr. There are other Ṇaymil, and Dätiwuy, places at Gäriyakṅur.

The central feature of Minbirkṅur is named Dhulmu ṅärra (lit. the important ceremonial place). It is described as the *bunḡawa* (boss) for the whole area and a very important place. I was carefully shown a rounded stone and told that there was a second one like it currently hidden by sand movement. It was explained that these were the transformations of the Djaṅ'kawu women themselves when they "went inside" here. The special nature of Dhulmu ṅärra was impressed upon me by different people in a number of ways.

With reference to the rounded stones, "The *bundurr* terms used during *buku-lup* (cleansing ceremonies) and *munatha* (sand sculpture) are Bandjurra, Bupuyurru and Djinmila, and their meanings cannot be printed". And again,

This is a very special place where women are not allowed to go. They can walk past along the beach and see it from there and pictures are all right. When the agreement was made for Liya-gawumirr to care for this country, this is the place it was made.

When some people go there they sing and pray . Once when I had a very bad boil on my neck and it wouldn't heal, I went there and kneeled down inside [near the rounded stone] and prayed to God, "God I'm here with these secret symbols that you gave us. Help me God." I got better then. No-one else done that.

The focus of Dhulmu ṅarra is the set of three large rocks (see Plate 5.1) that lean together supporting each other. It is near these, and "more inside" that the rounded stone is found. In this general area also, and below the high tide mark springs of fresh water bubble up from the sand at low tide. These are the springs mentioned earlier that were dug by the Djaṅ'kawu sisters with their digging sticks.

I have considered just some of the varied features of Dhambalaṅur. Even in this selection it becomes obvious that each of the named features has an extensive association with significant activities of ancestors or of mythological entities. It would be easy to extrapolate from this that all names for places were derived from such sources, but as I will show later in this chapter the naming of places can have a much more varied development. What does show clearly in this small collection of named sites is that the physical features of the geographic space function as a kind of reference tool for oral history. As one man said to me, the landscape functions as a library for the Yolṅu people. Each different feature is used as both a proof of historical or mythological events which are considered to have happened there, and as a memory peg to which the oral history is able to be attached. This is however a "library" with the potential for being continually rewritten, with the same "proofs" used differently for different purposes and as mentioned above, transferred from one location to another.

Ownership of areas, and proof of it as I have indicated earlier, is associated with control over such tangible evidence of ownership as sacred objects, paintings, song cycles, names and their meanings. In the above discussion of features at Dhambalaṅur, it was shown that several clans have particular interests in the area. Local (Elcho) tradition has it that the area is really Gunbirrtji country, but that they arranged for the Liya-gawumirr to

take over responsibility for it. The Garrawurra³⁵ received this authority over the site from the Gunbirrtjii on the basis of a statement made by the Gunbirri to them,

Narra djamany, nheny bungawa, nhe Liya-gawumirr. (We'll be the workers and you will be the bosses, you Liya-gawumirr).

As a result of this exchange and also as proof of it Daypurryun 2, now ceremonial leader of the Liya-gawumirr people paints pictures associated with the Djaŋ'kawu and their activities at Dhambalaŋur. As to how he obtained these rights personally, Daypurryun said that when his father died he inherited these designs from his father. He also said that the red paint used for painting this site is ratjpa (blood red haematite ore from the deposit at the Galiwin'ku town site), not miku (red oxide).

One of his paintings (Plate 5.3.) is in the Australian National Gallery in Canberra. Some time after having visited Dhambalaŋur and mapping the sites with Daypurryun, I showed him the photo of this painting and asked him if he would tell me about it.³⁶ At first he told me of the physical features of the landscape represented in it. As the features in the painting are referred to here the numbers referred to match those on the diagram of the painting in Figure 5.4.

The pattern of small circles (3 and 4) were representations of the waterholes or fresh water springs that are found on the sand at low tide in that area. They were, he said, dug by the Djaŋ'kawu using their wapitja (digging sticks). They are linked by rivulets of fresh water (6 and 8) and by mirriya luku (tracks of the crab) that run between them (7). The oval shape at one end of the painting (1) named Banydjarra, is a gunda (stone), the rock

³⁵ Garrawurra is the surname adopted by the Liya-gawumirr clan.

³⁶ I had not known until then that it was a painting of the central feature at Minbirkŋur.

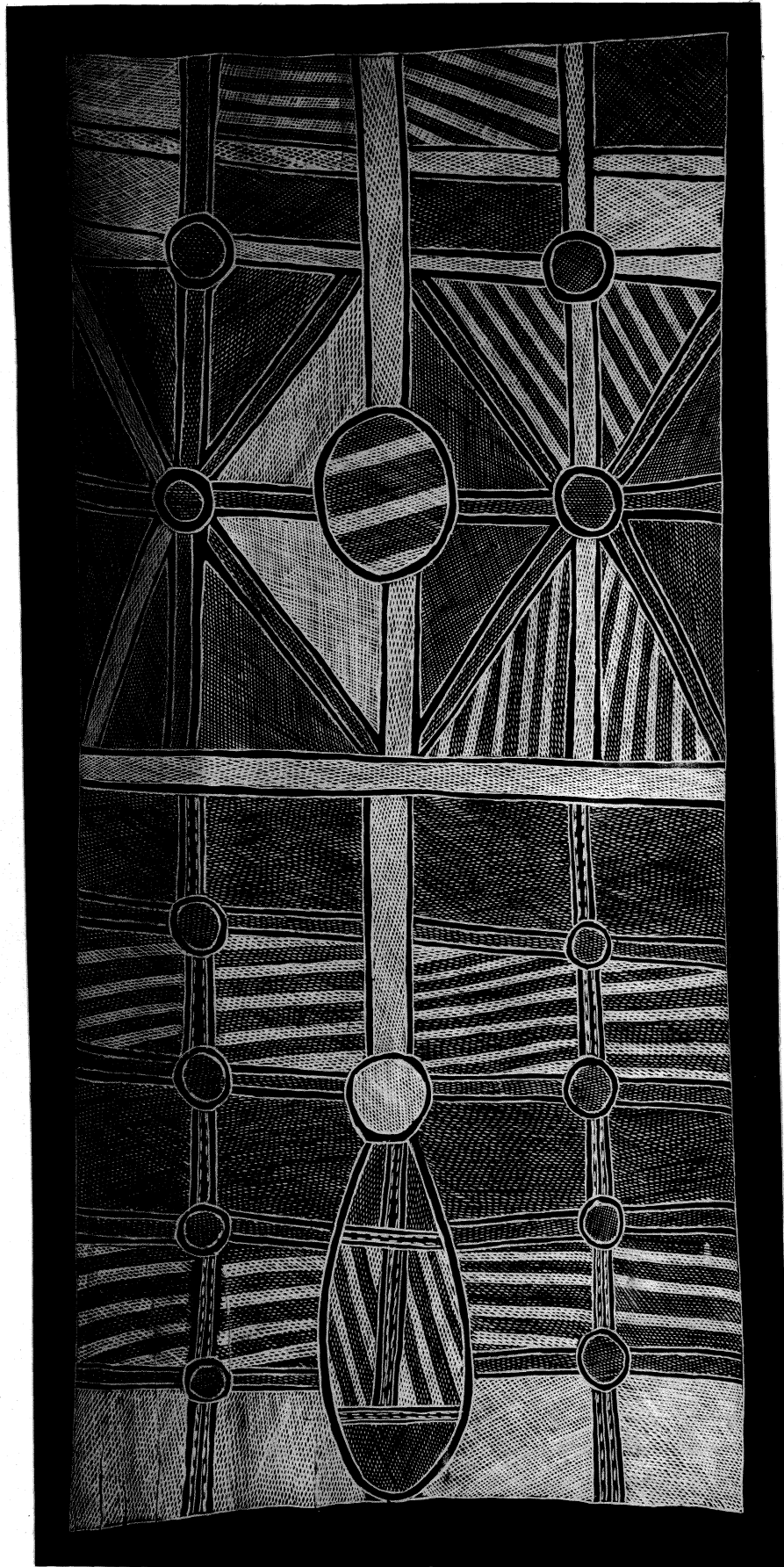

Plate.5.3. Bark Painting of Djan'kawu site at Minbirrkmirriḡur. (Australian National Gallery, Canberra).(See also Plate 5.1 and Figure 5.4.)

which is the transformation of the Djaŋ'kawu sister. The striped circle, (5) at the centre of the other half of the painting is Milminydjarrk and represents dirty water.

This was the initial explanation of the meaning of the painting, however over a period of time several other layers of meaning were explained. At a second level of explanation it was said that the Djaŋ'kawu brought *bathi* (baskets) as well as the *wapitja* (digging sticks) with them. The meaning of the oval shape at this level of explanation has changed so that it now represents the Djaŋ'kawu basket. At the end of the basket, the circle (2) is a waterhole dug by the digging stick. At first dirty water (6) comes up after the digging stick enters into dry places (4) then, after the first flowing of dirty water, the water comes up clear (8).

There was then a third level of explanation which was related to the sexual and reproductive capacity of women. The *wapitja* at this level is a penis. The woman's basket (1) is her reproductive organs. This is the same basket that is spoken of in the Djaŋ'kawu story as being stolen by the men, giving the men control over all the sacred objects, of which the representations of sexuality, copulation and reproduction are focal. At the end of the oval shape nearest to the waterhole (2) is a pattern representing the pubic triangle. This pattern is repeated in the diagonal lines at the other end of the painting. The water hole (2) is now perceived as the entrance to the vagina. The sections which were explained as clean and dirty water rising and flowing (3, 5, 6 and 8) are now explained as the various body fluids of menstruation and copulation.

There is a division (9) between two halves of the picture. One half appears to refer to menstruation focussing on the "water holes" (4) as the source of menstrual flow, with menstrual blood said to be indicated by

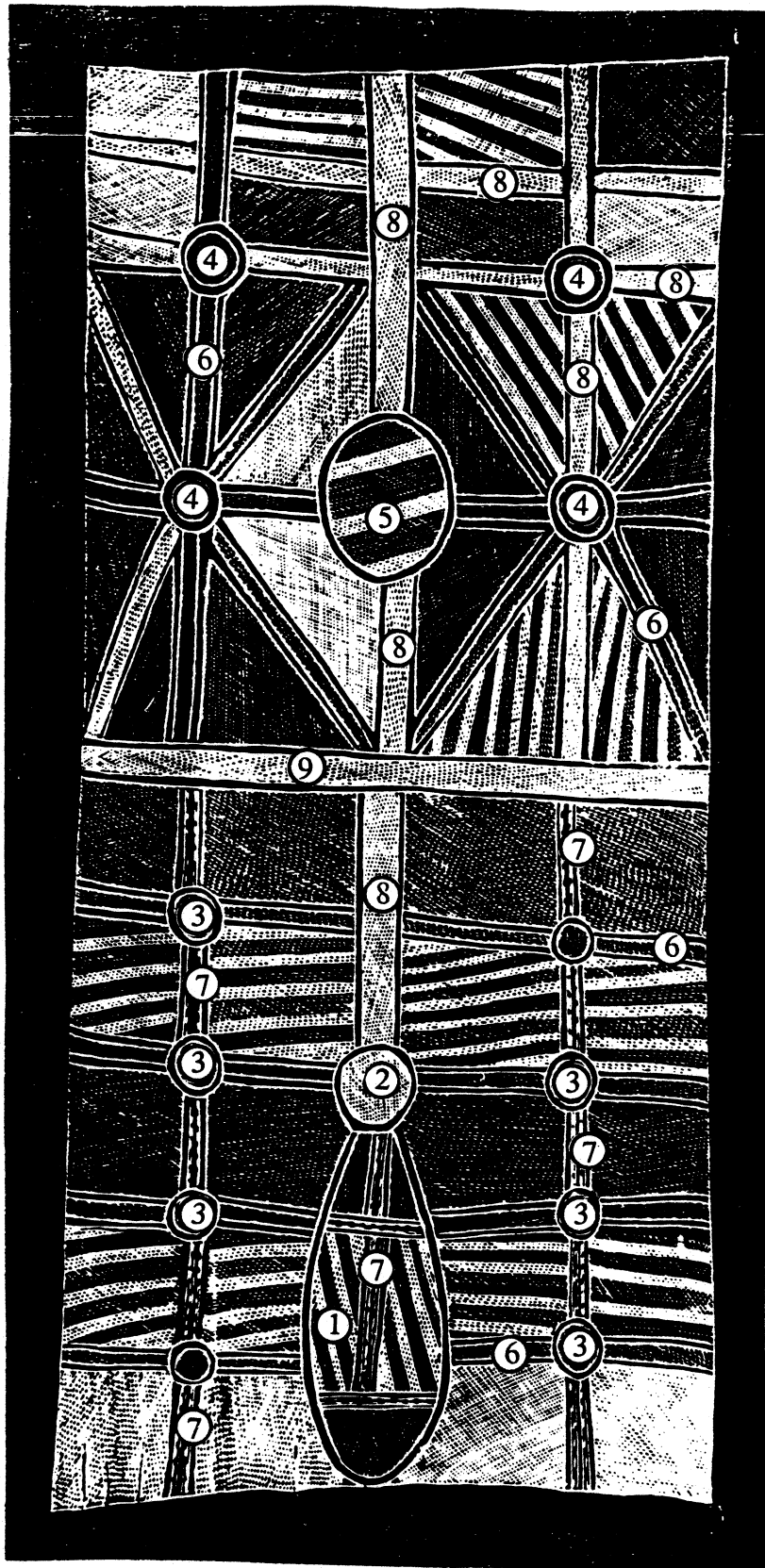

Figure 5.4. Features of bark painting by Daypurryun. (A.N.G. No 83.3198).

the dark lines flowing outwards from them (6). The other half appears to focus on aspects of copulation and procreation. The *mirriya luku* (crabs footprints) remain unexplained, but by implication of the other symbols could represent the flow of seminal fluids.

At this level of explanation the earlier levels are not replaced but incorporated as simultaneously true. The rock which is the Djaŋ'kawu woman is not just a rock but a transformation of the woman herself and of her basket. The rock is found inside the area known as Dhulmu Nj̄arra (lit. the important ceremonial place) where the arrangements for the transfer of ownership from Gunbirrtji to Liya-gawumirr were made (Plate 5.1). There are within this series of interpretations the implications that the earth itself is considered as female, and that on the basis of male action represented by the digging of waterholes by the *wapitja* (digging stick) the female earth becomes reproductive and brings forth. This is another representation of the idea discussed in Chapter 4 that a man can consider the earth itself to be the mother that his clan uses to reproduce its identity.

It can be seen from this discussion that in a significant site like Dhambalanur, the land is perceived as a physical space, but that simultaneously it is a non-physical space. It has both outside and inside aspects. The various rocks and springs along this stretch of coastline are rocks and springs and the fresh water that flows from such an area is fresh water for drinking (although some may have restricted access). These are all very physical objects. They are not just the outward form of something else. Nevertheless the rocks are not just outward form, they are also simultaneously something else. Each named rock is a physical rock but also a transformation of some aspect of the inner side of reality, be that a meeting place, a black cockatoo, a clan founder, an ancestral woman or her

reproductive system. This inside of reality is not visible to the physical eye, but is known through revelation. Thus in these ways the land has simultaneously a physical outside manifestation and an inside unseen reality.

Galiwin'ku Township.

Galiwin'ku, the major settlement on Elcho Island, has a flexible population of somewhere between 1000 and 1500 people. It was established originally as a Methodist Mission in 1942, but since the mid 1970s has been managed by an autonomous Aboriginal council. In the town live members of approximately 20 clans, (the number varies with the movements of people), who have come to settle from various areas within Arnhem Land. A small number of closely related and intermarrying clans can be said to manage the town and its facilities, largely to their own advantage.

In their control lies the ownership of the store, management of the council, (Galiwinku Community Inc.) and the church. The council has the responsibility for town management, oversight of the hospital and staff, supervision of most contractors, maintenance of peace, sanitation and roads, power supply and fuel, and they also have to deal with some fifty or more government agencies. Consequently the same group of clans also control the major sources of finance, employment, and the distribution of housing.

At the old end of the town, and separately financed by government agencies is the Marthakal Outstations Resource Centre. This has completely separate Aboriginal management which relates to a different set of clans and is concerned with the development of settlements in the various outstation or homeland centres. Of these, fourteen are on Elcho, another five on adjacent islands and twelve on the mainland. (See Map 5.2 and Table 5.2).

Both the Galiwin'ku Community Inc and the Marthakal Resource Centre employ a number of Aboriginal staff, plus white staff where work to be done involves management, accountancy, professional or trade skills that are unavailable in the Aboriginal community. The only other sources of employment are the store and the school. The store periodically employs a white store manager in addition to Aboriginal staff, and the school, while it employs the largest single body of white staff, also employs and continually upgrades the training of approximately 20 Aboriginal teachers.

In 1990 the relatively busy small airport had two permanently based Missionary Aviation Fellowship (M.A.F.) planes with 4 pilots with their families accommodated in the town. The airport serves as the major centre for the movement of goods and people to the homeland centres that are off the island. The aerial medical service based in Gove flies serious medical cases to hospitals in Gove or Darwin, and there are daily passenger/freight planes from Darwin. Apart from the store, the church, and several independent artists, the rest of the town is directly dependent on one form or another of government funding. This ranges from the salaries of those directly employed as government staff to capital grants, and various forms of pensions and unemployment benefits. Apart from hunting and gathering, which is actively pursued on the outstations, and the few artists, all other forms of production of goods and income ceased shortly after control of the town was transferred from the mission to the Aboriginal council. Therefore by proxy control is in the hands of the multiple government agencies who fund everything that is done and hence largely control the people's choices through the control of the use of the funds.

The original site of the settlement was between a freshwater swamp to the south and a permanent freshwater spring on the foreshore. The first cottages for the Yolŋu were constructed from timber sawn in the mill on the island. These were built on timber stumps and with timber floors. On Map 5.6. these are shown in the area marked "pre-1965".

Development of housing spread and by approximately 1970 a township had developed to the much larger area marked as "by 1970" which included a new church, school, sports oval, power house, a large market garden, and workshops for engineering, boat building, mechanics and carpenters as well as a saw mill.³⁷ The street named Dutungurra ran to the garden and the new airstrip to the north of the town and as it followed its course, neatly marked the boundary between the sandy area to the south and the rocky deposits of low grade iron ore on which the rest of the town has subsequently been built. A town plan was developed at that time which has been adhered to fairly closely ever since. Little further extension was made to the town area after 1980 and most of the houses built during that time were replacements for earlier small, and no longer suitable ones.³⁸

Under the Aboriginal Council, housing has been allocated to groups of related families living in separate areas. On the map of clan areas within the town, seven of the ten areas identified can be classified as being occupied by intermarrying pairs of clans, with the larger clans dominating the

³⁷ Mission staff initiated market gardens, engineering, fishing, furniture manufacture, forestry and sawmilling. These were all closed down by government agencies by one method or another as unviable. With their closure, all training and employment in these areas ceased.

³⁸ Currently there are a number of cottages, empty for one reason or another that are being gradually demolished by small children as they await replacement with new buildings.

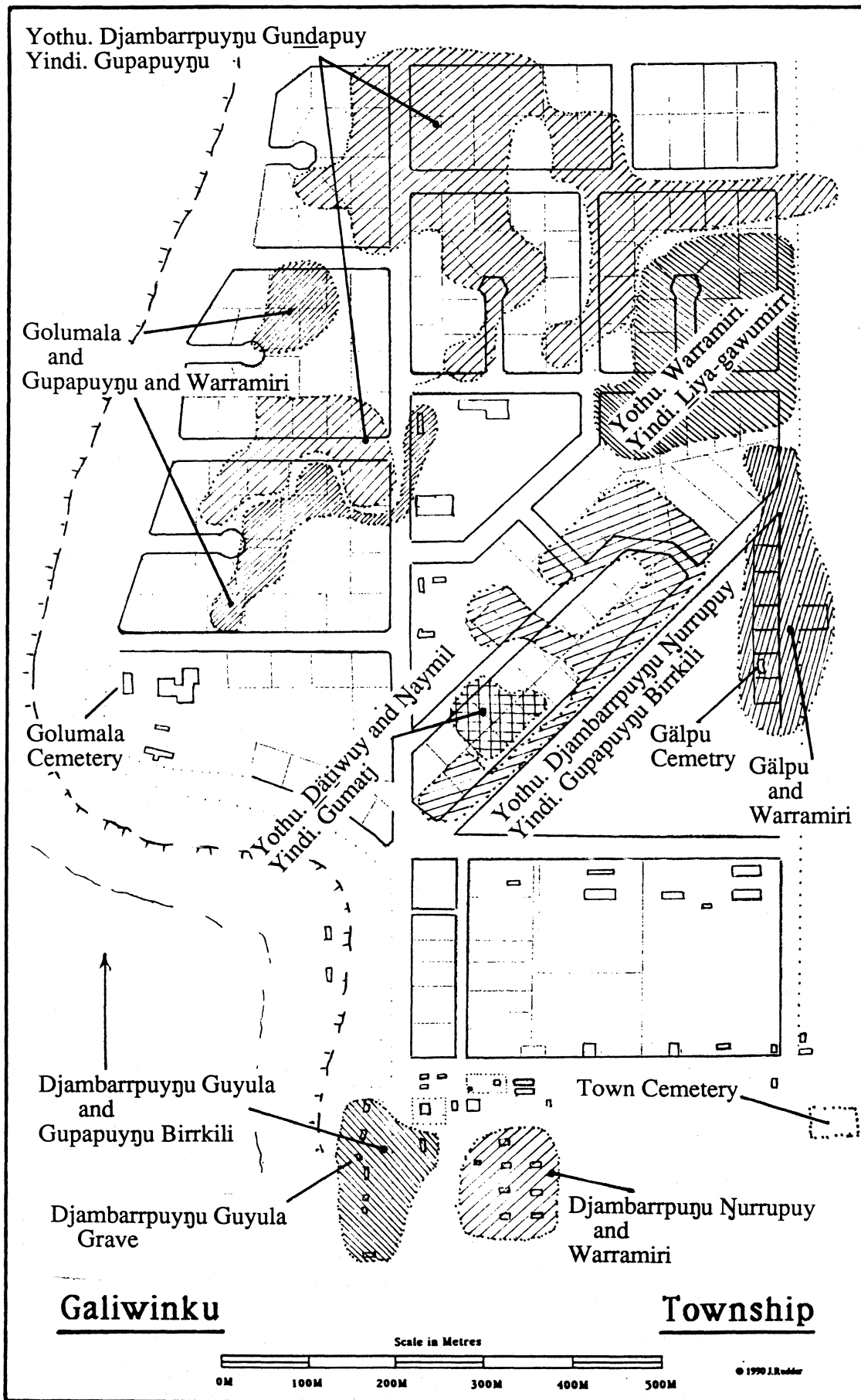

Map 5.7. Galiwin'ku township showing areas of clan settlement and Cemeteries.

newer areas, and representatives of smaller clans scattered amongst them. These groupings are shown in Map 5.7.³⁹

According to local tradition, the town area, as part of the southern section of the island is, as already mentioned, owned by the Gunbirrtji people, with just the one young Gunbirrtji man in the town who is stated by some to be the traditional owner. When Harold Shepherdson first visited Elcho and sought approval to establish a mission there, he visited the two "old" Gunbirrtji women who lived there. He brought with him two Yolŋu men, Wili Walalipa of the Golumala clan and Baṭaṅga of the Wangurri clan to act as interpreters. Wili, according to one Yolŋu man had been given agreement to come by Gunbirrtji people at Milingimbi. This was affirmed by the "old ladies" because Golumala had connections with the Gunbirrtji through sharing the *Warrukay* (Barracouta) site with them. From the Yolŋu point of view it has been through this *Warrukay* connection that Golumala gained their rights in the town as it developed, rather than by the historical fact that Wili came across with Harold Shepherdson to help in the establishment of the mission, although this latter fact is used as support for their claims. Because Golumala and Naymil have equal rights in *Warrukay*, they gain some rights in the town area through that connection.⁴⁰

The Liya-gawumirr clan have a very close association with Gunbirrtji through ceremonial and through acting as caretakers for the Djaṅ'kawu sites at Dhambalaṅura in the southern end of the island. If the Gunbirrtji clan were to completely die out, they have established a primary claim to inherit the area.

³⁹ Relations between the pairs of clans involved (*yothu yindi* pairs) were discussed more fully in Chapter 3

⁴⁰ They also have other strong claims in the rocky iron ore area together with Dätiwuy through both *Banumbirr* (the Morning Star) and *Wäraṅ* (the sugar glider), who brought the *ratjpa* (iron ore) to Galiwin'ku from their country at Rorru. (See also Chapter 7).

Djupandawuy of the Gupapuyŋu Birkili, a Yirritja clan, is eldest son of one of the two "old" Gunbirrtji ladies, and through this has gained rights for his family line in the local land as indicated in a quote from one of his sons earlier in this chapter. These rights have more recently been reinforced by his sons having married five Golumala women, and a woman each from Dätiwuy, Ŋaymil and Liya-gawumirr clans all of whom have rights in the town area.⁴¹

In spite of all these claims and counter claims, the Gupapuyŋu Djambarrpuyŋu combination, by virtue of the simple weight of numerical strength, appears to occupy the largest number of houses. The Liya-gawumirr are mostly on the eastern side of town, Gälpu and Warramiri on the south-east of the newer section, while Ŋaymil and Dätiwuy, both very small clans have been almost completely excluded from the power structures. In contrast to them, Golumala, achieving an initial dominance through both the mission structure and the ceremonial links, have gained a disproportionately large number of houses and also of executive positions in the town.

The southern end of the town, approximately south of Galawarra Rd, is part of a section of land owned by the Liya-galawumirr clan (distinct from Liya-gawumirr). This includes Mission Beach and the area of the swamp which drains out at the southern end of the beach. I have not discovered who has subsidiary rights in this section, but Djambarrpuyŋu Guyula clan have established some rights there by having lived there for over forty years and recently by burying one of their senior men there.

⁴¹ Thus their children inherit rights through both matriline and patriline.

There has been a town cemetery in use since the foundation of the mission. In addition to this and for a variety of different reasons, there have, in the last ten years, been three groups who have buried clan members adjacent to the houses in their areas of town, and two of these have developed into small clan group cemeteries⁴².

The Gälpu clan buried the senior member of their clan on a vacant lot between the houses in 1981. Later a second senior man was buried beside him. In the 1989 wet season, a much loved young man from the same group was to be buried in the town cemetery, but when the grave was dug there, the water table had risen and the grave filled with water. As a result the choice was made to bury him beside the old men (Plate 5.4).

In 1983 the Golumala clan chose to bury the senior man of their clan on a *Warrukay* (barracouta) site adjacent to their homes and next to the hospital which is also built on the site. Their choice has been explicitly stated as an action to emphasise their claim to the adjacent section of the town to live in on the basis of their particular rights in the *Warrukay* ceremonial complex. Since that time several further members of the family have been buried there (Plate 5.5).

The third clan area involves a single grave in the southern end of town which has been located right beside the "Elcho Island Memorial" (described by Berndt 1962). The memorial has been gradually surrounded by houses built for the Djambarrpuyñu Guyula group who have since the 1940s lived adjacent to the beach. The old man buried there belonged to the clan and his daughter lives in the house seen in the photograph as next to the grave and the memorial. (Plate 5.6)

⁴² See Plates 5.5, 5.6. and 5.7. and Map 5.7. 230



Plate 5.4. Graves in the Gälpu Cemetery

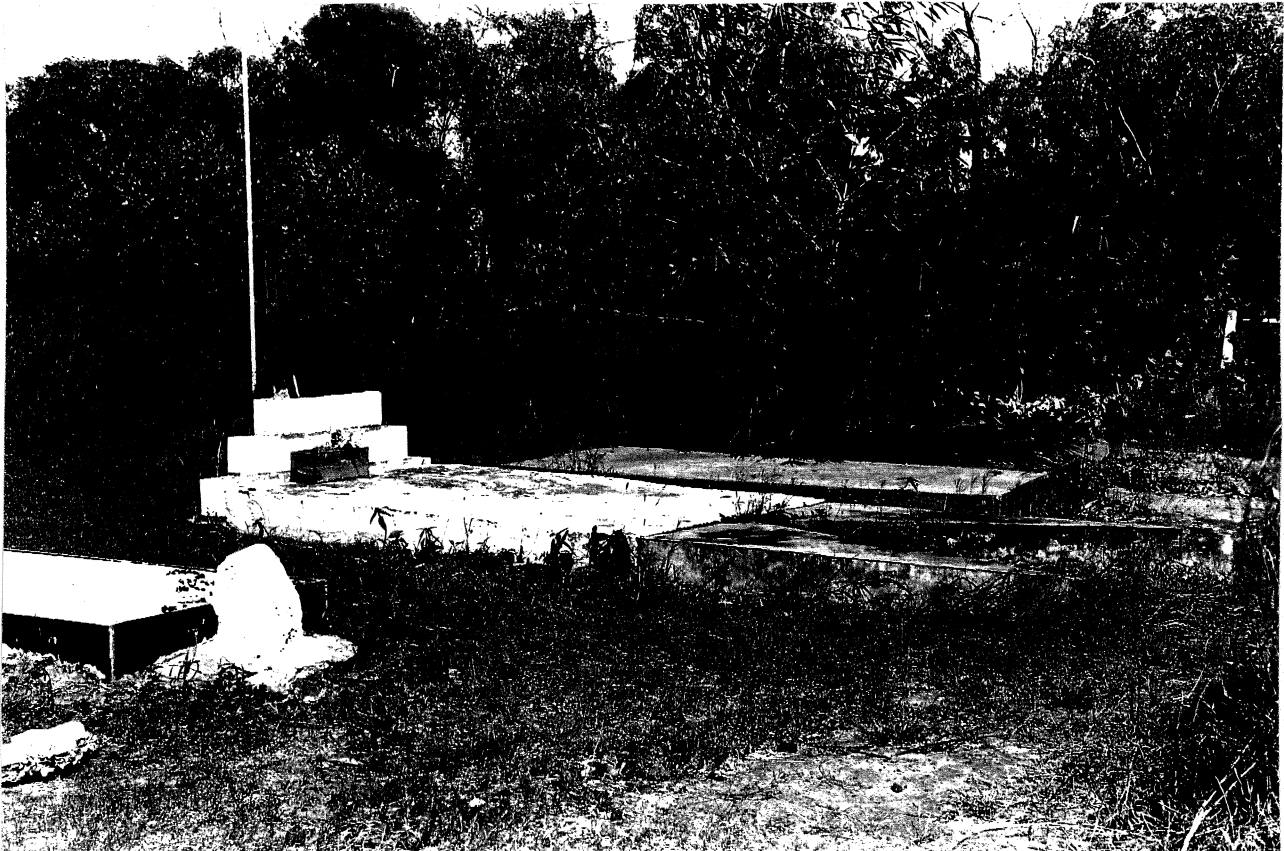

Plate 5.5. Graves in the Golumala Cemetery at Nalkannur.



Plate 5.6. Djambarrpuyŋu -Guyula Grave beside the "Elcho Island Memorial".

In summation then, the township of Galiwin'ku is a ferment of Yolŋu politics, a continuous scene of claim and counter claim with all potential bases for leverage being employed; every act, every word spoken carrying within it some political implication. Every action is weighed and then counterbalanced as far as possible. Every marriage is considered in terms of advantage and disadvantage. Every funeral is, among other things, a statement of relationships, a levering for advantage and an occasion for imposing obligations on others. The establishment of dominance over individuals both Yolŋu and white, over groups such as clans, "missionaries", town departments or government agencies, and over economic assets all eventually lead to the aims of control over religious elements of all kinds and through them towards long term goals of control over land.

All of these actions then appear to be aimed at the ego-centred expression of a powerful identity; the Yolŋu equivalent to big-man-ship. This when interpreted through the idea of an unchanging eternal identity enables the perception that dominance is justified by the eternal unchanging reality of that which is, which verifies the dominance as an expression of the innerreality.

Space Beyond Arnhem Land.

For a considerable length of time, the Yolŋu have been aware that the physical world was much bigger than their own country of North-east Arnhem Land. For centuries there were regular visits from Indonesian sailors collecting a variety of products from these coastal lands. At various times, some Yolŋu had returned with them to Indonesia, or Mangatharra as they called it, so that there was no consideration that Indonesia was anything other than a real place. More recently, during this twentieth century with the continuously increasing contact with the rest of the world, Yolŋu have

travelled to all the continents except Antarctica and perhaps South America. Some have been to Africa, others to America and Asia. In 1988 a party of over twenty visited Israel and Germany and others have visited New Guinea, the Pacific Islands and South-east Asia. More recently, the Yolŋu band named Yothu Yindi has toured the United States and some of Europe. The number who have visited at least the capital cities of Australia is quite large. For some, long distances have become no more significant than a trip to the other end of the island. With television in most homes now, the whole world, and even outer space, has become part of the Arnhem Lander's environment.

One question that this widened experience presents in terms of the purposes of this thesis is, "What effect if any, this has had on the Yolŋu cosmos and on their interpretation of it in their cosmology?" One response to this broader experience has been for people to incorporate aspects of the wider world within their traditional framework, as the following texts indicate. George Daynumbu shared the following perceptions of extensions to Yolŋu geographic relations by means of links through *madayin* (sacred) items.

One story, I'll talk about the *madayin* (sacred things), I'll give an example about myself from the Mandjikay *bäpuru* (group), we Mandjikay used to think mistakenly in the old days that the Mandjikay finished from Dhälinynŋur and Gumatj and Madarrpa and Dhalwanu and Mangalili groups. That's what we thought was the limit of Mandjikay, but we Mandjikay went further like to Groote Island or Numbulwar or to Roper River or Mornington Island or Weipa or on further to Palm Island or Thursday Island. We find that Mandjikay is there as well, because on that other side we find connections there, our familyship truly continues on there because they really have our *madayin* (sacred thing) there. The sacred *madayin ranga* (sacred objects) gives us familyship. We used to think that we had a limit where we stopped with the Madarrpa people, and back this way from there. And now we can consider the direction of the sunset, maybe its just the same over that way, those Mandjikay continue on that way too through the one *madayin* (sacred thing) continuing they have *gamunungu luku* (sacred designs) we have in the one way *balanya bili* (just like that). Now we know we (Mandjikay) go far away. Our

relationships are firm and truly through the one *maḍayin* (sacred things) and through the *luku gamunungu* (sacred designs).

Like those Yolḁu over at Broome have Djaṅ'kawu, there is part of the family there Djerrkuwuy Yolḁu and the further we go on the further we find the same traditions, like Andy (Galiwinku's resident Makassan) but further west we find the same people with the same traditions there, same *maḍayin* (sacred things) goes on and on like that.

This aspect of finding ceremonial links and hence establishing what relationships exist with other Aboriginal people appears to be quite widespread. One young man, Brian Djangirrawuy, who had travelled throughout Queensland touring with an Elcho Island music group made the following comment,

While on a band tour through Queensland we discovered relations at Koenyama, and Lockhardt River. We had *gurtha* (fire), *guku* (honey), and *wurrpan* (emu), so we must be *wāwa* (brother).

In both these quotes, the assumption is made that the relationships were in existence before they were discovered. The discovery identifies the particular relationship not just between the people, but also between the places. Dayṅumbu's experience of finding shared ritual elements enables him to recognise that on this basis those that have the same as him are relations, and as Djangirrawuy explains, it is possible to attribute exact kin relationships on this basis.

In the past, celestial space has been considered as a transformation of the normal everyday space inhabited by the Yolḁu, a transformation which has occurred as a result of specific actions or events. Myths associated with the heavenly bodies appear to be of two types, those known to be associated with ceremonial like the Morning Star complex discussed in Chapters 7 and 8, and those of what could be called the "just-so" type in the Kipling sense that they tell about the origins of certain of the

celestial bodies.⁴³ While fairly widespread, there is no unified body of such stories. There are some celestial bodies for which variations of a single story can be traced right across Arnhem Land. Others may have several different explanations of origins within a single community.⁴⁴ No conflict appears to be seen when stories of the same subject having completely different details. It would appear that for each narrative, truth is according to the context of the narration and the stories are able to be used differently for different purposes.

Each of the identified celestial bodies, as mentioned above, is seen, at least in traditional stories, as associated with a human event. Elements of the human event are described as historical experience, the evidence for which is now visible in the sky. Most of these stories have clan-specific ownership although those with ceremonial associations are owned by all those clans which share the ceremonial complex together.

In the 1990s these myths are still preserved but in the confrontation with the input from television programmes and Western education are described in terms of, "These are the stories from our culture". Thus celestial space is now seen as having different explanations each of which tends to be kept in its own cultural box. There are known traditional explanations of space as transformations of human space on earth, and known Western explanations of physical objects in space. I have no record of anyone denying the veracity of either explanation and it would appear as if they are simply held as alternative explanations relevant to different contexts.

⁴³ I would suspect however that in the majority of cases where a myth can be identified as being of this latter type, there either is, or was a ceremonial counterpart.

⁴⁴ There are totally different stories of the Milky Way told by the Mangalili at Yirrkala and the Liya-galawumirr at Milingimbi and Elcho Is. In contrast to this the Morning Star has a single story with variations which can be traced from the Djapu and Gälpu in the south-east of Arnhem Land, to groups of the Burarra speaking people who live outside the Yolngu language area on the central north coast.

CONCLUSION.

In the discussions throughout the various stages of this chapter it has been demonstrated that the Yolŋu have a pragmatic perception of the physical space in which they live, of its assets and of the political processes of relationships, leverage and patronage that are used in seeking control over or access to such assets. Such access is a continually fluctuating dynamic involving a constant interplay and the ongoing development of new strategies such as the development of clan cemeteries as a means of staking or emphasising claims.

Beyond this perception of physical, outside attributes, the land is also simultaneously recognised as the place where the "inside" or spiritual reality becomes manifest. This is recognised in the naming of sites and the mythological descriptions of various features of the land. There are seen to be variations in the intensity of such manifestations. Some places are simply recognised as the location of events of significance. At other places the manifestations are far more intense and there are traces in the landscape which are in themselves manifestations of, or transformations of some aspect of the living entities of the inner side of reality. In this way physical space itself becomes, not just the place in which manifestations of the inner spiritual side of reality occurs, but in varying degrees or intensities, and more intensely in particular locations, physical space is itself a transformation of the inside of reality.

Thirdly the land, through this pattern of transformations, is converted into a series of interlinked sites held together in a network of relationships with each other, with the sacred elements associated with the beings manifest at the sites, and with the human groups affiliated with these. This huge multi-layered network of relationships functions as a constantly

changing organism in which the only thing which is reputedly unchanging is the relationship between the sacred elements and the sites. As a result there is constant political manoeuvring to either gain or maintain control over these elements and hence over the sites.

Not only are all such levels of relationship relative to all other levels of relationship, but the location of any element in space is seen to be relative to other locations, and distances relative to other distances. There are no absolutes of measurement of space in any part of the cosmos, and without absolutes this relativity is reflected in all associated aspects of the language.

Because the network itself is constructed of points which may be sites in space, sacred elements, or human groups, linked together by relationships, and because the identity of the points depends on focus and not on boundary, there are potentially no boundaries to the space which makes up the Yolŋu Cosmos. New experiences, new knowledge, new contacts with the outside world or beyond it are simply recognised as parts of the cosmos previously unknown, and then, if relevant, brought into relationship.

CHAPTER 6. YOLŪ TIME.

INTRODUCTION.

The Western Notions of Time.

YolŪ notions of Time.

TEMPORAL LOCATIONS.

Features of the repeated patterns of Day and Night

The Repeating Pattern of Seasons.

Other Repeating Patterns of Temporal Locations

Associated with the Moon.

The Tides and Tidal Currents.

The Stars.

Repeating events relating to plants.

Incorporations and Changes since Western Contact.

CONCEPTUALISATION OF TEMPORAL SPACE AS REFLECTED IN THE LANGUAGE.

Verbs.

The Demonstratives.

The Construction of the Terminology of Temporal Location..

Temporal Words and the Structure of Descriptive Terms.

DISTANCE IN TEMPORAL SPACE.

CONCLUSIONS.

YOLŊU TIME.

INTRODUCTION.

In the earlier chapters I have presented in various contexts the Yolŋu claim that there is no change in the "inside" reality, showing that this includes human identity and the inner nature of all things, and that what is observed is an outward transformation of this unchanging inner side of reality.

This being so a problem automatically arises when the concepts of time are being considered, as time, by its nature, is associated with the passage of events that occurs in association with change. The question put simply is, "How is it possible to understand time if one presupposes an absence of change?" The Yolŋu answers to this question are the subject of this chapter. In earlier chapters I have shown that the observations of transformation are able to be related to perceptions of changelessness and I show here how this relates to perceptions of time. I will also attempt to show here how the attempts by Western observers to explicate these relationships have resulted in the white Australian concept of "The Dreamtime". By way of introduction to the subject I first examine briefly some of the basic differences between Western and Yolŋu notions of time.

The Western Notions of Time.

Western ideas of time and the measurement of time have a long history with attempts being made to extend this to prehistoric stone structures found widely spread across the British Isles and interpreted by some at least as early observatories. Written statements relevant to the conceptualisation of time can be traced back at least as far as the ancient Greeks and Hebrews. Isaac Newton, as early as the seventeenth century in England was describing the conceptualisation of time in much the same way as it is currently understood. Newton (1687 quoted in

Park 1980:24) suggested that, there is a contrast between "absolute time" which is "duration" and "relative time" which is the measurement of duration. He wrote that,

Absolute, True, and Mathematical Time, of itself, and from its own nature flows equably without regard to anything external, and by another name is called Duration: Relative, Apparent, and Common Time is some sensible and external (whether accurate or unequal) measure of Duration by means of motion, which is commonly used instead of true time; such as an Hour, a Day, a Month, a Year . . .

Goodman (1964:367,368 as quoted in Schlesinger 1980:3,4) discusses the analogous relationship between space and time. In this he draws out one clear contrast between these two dimensions making the observation that position in time cannot be altered. He says that,

. . . the analogy between space and time is indeed close. Duration is comparable to extent. A thing may vary in color in its different spatial or its different temporal parts. A thing may occupy different places at one time or the same place at different times, or may vary concomitantly in place and time. The relation between the period of time occupied by a thing during its entire existence and the rest of time is as fixed as the relation between the region the thing covers during its entire existence and the rest of space. And yet there is this difference: two things may approach and recede from each other in space, they grow more and then less alike in color, shape, etc; but *two things never become nearer and then further apart in time*. The location or the color or the shape of a thing may change but not its time. (emphasis mine)

Park (1980.40) in considering what time is, gives what he says is a definition, as follows,

Time is what is measured by a clock, [adding that] A clock is a device whose law of motion is known [and (p43) that] In Newtonian terms, clocks measure the flow of time..... we do not sense the flow of time at all, but rather the flow of events, and in these terms the ticks of a clock are merely some more events, controlled, counted, and registered.

It should be noted here that this interpretation of "clock" by implication includes any cyclic movement used to measure the duration of or the "flow of time". Having established that this duration, or flow of time is perceived as the flow of events, he indicates that there are two kinds of events. It is, so he argues, the duration of one kind of event (unilinear and non-cyclical) that is measured in

relation to the passage of various consistently repeated (or cyclical) kinds of events.

He then (p59) elaborates the distinctions between these two kinds of events.

The natural events by which we measure time fall mostly into two categories: those which are fundamentally very simple and those which are very complex. The simple ones are the original clocks of mankind: the earth that spins once a day (as we would say) and orbits the sun once a year. The other set of physical processes from which we derive our conceptions of time are of an entirely different nature: the growth of children, the changes in our own bodies and minds from hour to hour and from year to year, and, on a larger scale, the gradual changes in the earth's landscape of which we are dimly aware. In these processes the direction of time marked *past* is not for a moment marked *future*. Everywhere, at every instant, a single principle orders the flow of events. It does not control their rate but it decrees their direction in time. It is the second law of thermodynamics.

When the implications of this discussion are considered, it is possible to suggest that the locating of a particular event in time, and the process of the measurement of time as practised in Western society have been developed from basic observations of the relationship between the events being measured and the cyclical movements of the earth around its own axis, and in its relation to the sun, (although this was originally considered the opposite way around)¹. Time span can be considered as the duration between the recurrence of particular features. The duration between successive noon sun positions gave us the duration or length of a day, which was then divided into arbitrary units of hours, minutes and seconds. All of these are used by the ordinary citizen to mark, with varying degrees of precision, the passage of time along an irreversible continuum, for the location of events along that continuum, and for the measurement of duration between events.

This system of measuring duration has been extended by counting the days between summer or winter solstices, calling that number of days a "year" and arbitrarily dividing this into months. Years have been identified specifically by

¹ More sophisticated measuring devices have been developed to measure duration, but this basic principle appears to have remained unaltered.

counting their number from a chosen reference point, and months given names by which they can be identified and numbered according to their sequential order.²

The Western conceptualisation of time can be said to be based on a set of presuppositions and a number of focal concerns. For the purpose of comparison with the Yolŋu approach I have isolated the following presuppositions.

- a. Time is an entity which exists independent of events³. (Newton's 'Absolute Time').
- b. Duration (time) occurs in an unlimited linear continuum.
- c. There are standard units of time by which time can be measured.
- d. Points of time can be identified (at ever more precise locations) along the continuum of these standard units of duration.
- e. Location in time can be identified in relation to these hypothetical points on the continuum.

In addition to these presuppositions, the following focal concerns can be distinguished,

- a. a focus on the duration of any event, and its measurement,
- b. a concern with the speed with which an event occurs.
- c. a focus on precise identification of the start and finish of an event,
- d. a concern for ever increasing precision of measurement.

Yolŋu notions of Time.

In contrast to the Western focus on the continuum of time, the Yolŋu focus is on the location of and power of events that occur in temporal space.

Amplifying this a little, their concerns can be said to be with,

² This point is an over-simplification, but is as accurate as is needed for the present discussion.

³ This appears to be a universally accepted fiction, whereas what has been established is a system for measuring duration between events

- a. the location of events in relation to other events (that is the location markers in temporal space) and in geographic space
- b. the relationships between events,
- c. the intensity of, or power involved in an event, and,
- d. duration, primarily as an assessment of the effort (power) involved in an event.

With this focus on events it becomes necessary to examine the types of events that can be considered as in any way related to the Western notions of the passage of time and the methods of locating events. In attempting to do this, I have isolated, for discussion purposes, three different categories of event. While they are my categories, and not as far as I know overtly Yolŋu ones, they would cause Yolŋu people no difficulties in discussion.

The first two of these match neatly with the two categories of events described by Park (and quoted earlier). These are firstly, the set of continually repeated events of the natural world such as the patterns of day and night, and the annual return of the seasons (e.g. Figures 6.1, 6.2 and Tables 6.1, 6.2 and 6.3). The second is the overall succession of unique experiences of the human lifespan along which the events of the past, the present and the future are fitted (e.g. Figure 6.3). In the discussion which follows I describe these two types of events as fully as I am able, but the third type of event only in passing. In this third category are those everyday and not so every day human and non-human events that are located within the frameworks of the other two. That is, it is because of a need to locate this third kind of event, that the first two types are used as sets of locations.

It can be said that when the Yolŋu identify the temporal location of a particular event, they identify a specific relationship between the event and one of the repeating events or one of the unique lifespan events. Precision in this reckoning is then relative to the choice of particular events.

This could almost be a description of the way the time of an event is decided in Western society, though we would not normally express it this way. However it is not just at this level that the contrasts lie, but also in the kinds of events that are chosen, the ways in which they are perceived, and in the different foci that the Yolŋu have in their approach to time. In addition to this, the focus on event rather than on time or its measurement, when combined with the absence of any developed counting system⁴ has repercussions in the Yolŋu approach to chronology and distance in time, which I will discuss separately, but first I turn to an examination of the cyclical events.

In the sections that follow, I examine Yolŋu ideas of the types of temporal events that exist, their systems of classifying such events, their approaches to distance in time and the passage of time, and I consider some of the ways in which various aspects of the Yolŋu approach to time are reflected in the language structures. Following this I will attempt to relate these ideas to other Yolŋu perceptions of the Cosmos.

TEMPORAL LOCATIONS.

There are two major sets of repeating events used in the classifications of specific locations and some others that have less significance. One of the major sets relates to the Western category of the twenty-four hour day, and the other can be paralleled to the Western perception of a cycle of seasons.⁵ Juxtaposed on these two major sets of events the other minor sets include the movement of stars, of the moon and the tides.^{5b} Associated with them are known wind patterns which appear to form cosmological events in their own right. Supplementary to these events, are

⁴ See Rudder 1983:54-94.

⁵ I have deliberately referred to these as repeated events rather than as cyclical to avoid the implication of continuum carried in the latter term in English. If a Yolŋu idea of continuum exists, it is as a continuum of sameness or changelessness.

^{5b} For a general evaluation of the ways the perception of time in other societies has been discussed in the anthropological literature, see Munn (1992:93-123).

the repeated patterns of reproduction, and growth, of non-human living things by which the seasons themselves are identified.

Features of the repeated patterns of Day and Night

The day consists of a succession of time events treated as recurring states each of which is identified, not simply by the position of the sun in the sky, but by what are considered to be the significant features of the particular segment being classified so that each event is a temporal space with its own particular set of qualitative attributes is seen to be effective, and each event then becomes a state in which any continuum quality is classified out. These features include such events as the positioning of sun, moon or stars, the pattern of human activities, the position/direction of shade, the behaviour of natural species, and, on the coast, the position of the tide.^{5c}

Morning is the time of hunting, and of people going out from home, with some degree of expectation and excitement. Afternoon in contrast to this can be a time of apprehension and of concern for the well being of other members of the group, and there may develop a continual flow of questions concerning the well-being of those not yet home. e.g. "Have they got into trouble?" "Has he been bitten by a snake?" "Is she lost?" "Have they got a big turtle that has slowed them down?"

The segments of daylight hours which are of significance to the Yolŋu are illustrated in Figure 6.1, drawn to show an approximation of the view to the south along the beach at Galiwin'ku. The succession of positions of the sun overhead is represented as seen by a small group of people sitting in a "shade" on the beach, by the curve of circles from left to right. The corresponding Western hour of the day is shown as the sun's approximate position each hour. Terms

^{5c} Geertz (1966:42) suggests that noting such events is one of the "ways in which men are made aware, or rather make themselves aware, of the *passage* of time" (emphasis mine).

<i>djadaw'yunaray</i>	half light before sunrise.
<i>goŋ-djalkthunminyaray</i>	sunrise (lit. the sun throwing its hands out).
<i>godarr'-munhawumirri</i>	early morning to about 8 a.m. (lit. morning having the quality of night about it).
<i>godarr'</i>	morning, from sunrise to approximately 10 a.m.
<i>godarr' galki dāmbuy waluy</i>	approximately 10 a.m. to 11 a.m. (lit. morning close to the the sun striking the top of the head).
<i>walu garrwaryu</i>	the sun is up.
<i>läyyu-waluy</i>	= approximately 10 a.m. to 11 a.m. (lit. the sun shining on the side of the head.
<i>liyay-waluy</i>	= approximately 11 a.m. to 1 p.m. (lit. the sun striking the top of the head).
<i>läy-bilyunaray</i>	= approximately 1 p.m. to 2 p.m. (lit. sun turning to strike the side of the head again).
<i>milmitjpa</i>	= approximately 3 p.m. to sunset, the later half of the afternoon.
<i>walu-gärrinyaray</i>	= sunset. (lit. the sun going in).

Table 6.1. Terms used to identify sections of the day.

located below the level of the horizon represent the classifications of the night. In the figure they are placed in a position approximately analogous to where I imagine the sun's position to be at night. Each of the Yolŋu terms identifies not so much the demarcation of points along a continuum, but the classification of static slabs of the day when a particular set of qualities is observed. They can be translated or described as in Table 6.1.

In the same way that one series of events can be identified as occurring during daylight, so a different series of events as shown in the figure can be

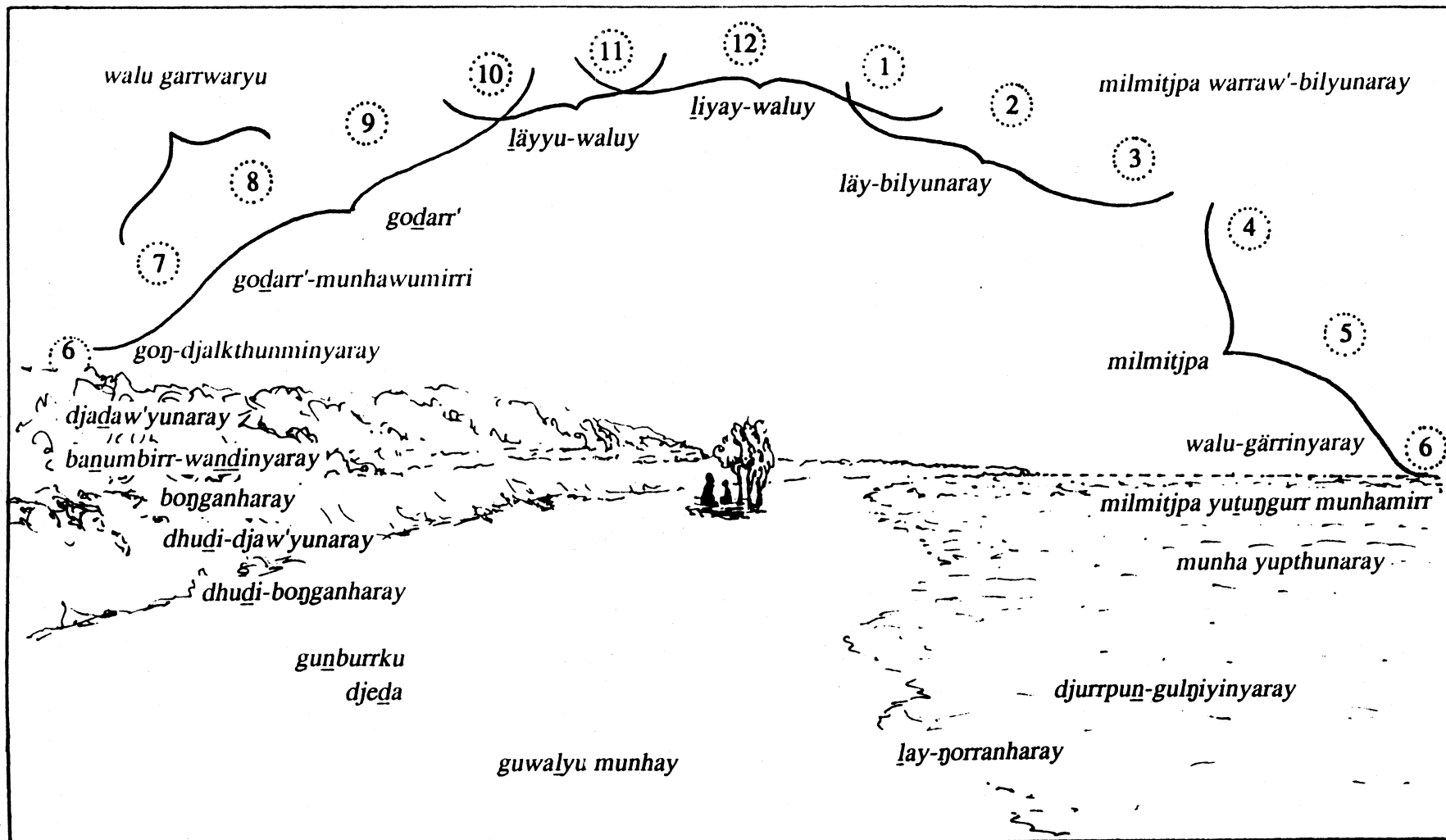

Figure 6.1. Pattern of sequential temporal locations relating to day and night

identified as occurring during the time of darkness. The classificatory terms frequently used to identify these events are as in Table 6.2.

Temporal Spaces of Darkness	Definitions
<i>milmitjpa yuṯuṅgurr munhamirr</i>	twilight.
<i>munha yupthunaray</i>	the beginning of night. (lit. at night fall).
<i>djurrpun-gulŋiyinyaray</i>	approximately 7 p.m. to 9 p.m. (lit. the evening star goes in).
<i>läy-ŋorranharay</i>	time for sleeping. (lit. side of head lay down).
<i>guwalyu munhay</i>	approximately 1 a.m. to 3 a.m. (lit. the waist or middle of the night). The first of the morning stars coming up.
<i>djeda</i>	approximately 2 a.m. to 4 a.m. The quiet time of the night when everything is asleep
<i>gunburrku</i>	approximately 4 a.m. to 5 a.m. when the night becomes cold.
<i>dhudi-bonganharay</i>	early morning before the main morning star rises.
<i>dhudi-djaw'yunaray</i>	second morning star rising.
<i>bonganharay</i>	the third or main morning star is rising.
<i>banumbirr-wandinyaray</i>	dawn as the morning star fades. (lit. the morning star runs away).
<i>walu-dhudi-nhirpanminyaray</i>	the sun - bottom - puts down

Table 6.2. Terms used to identify temporal spaces of the night.

While everyone knows that the time events occur sequentially, the process of classification focuses not on the position in a continuum but on the qualitative event itself, and the classification can be seen to be the identification of one event in a known series of events, with any event being marked and identified by the expression of a known set of qualities. Sunrise and sunset can then be seen

in context not as time points but as acts in a regularly rehearsed drama. In the context of this regular drama any additional classifications are simply alternative ways of identifying other qualitatively distinguished slabs of duration.⁶

In Figure 6.1, it is clear that the day is divided into a series of classifications that represent qualitatively different sections of the day. The majority of these cannot be considered to be marking off points of time, as they unequivocally cover what in Western thought amount to periods of some duration, though the variations in length are quite considerable and the periods of time covered by each overlaps with the ones on either side of it. Several of the terms could be interpreted as either time events or as points in time, but on the basis that most represent classifications of qualitative states which replace each other in sequence, it is my argument that the whole set need to be considered as forming a continuous sequence of transformations from one state to the next. Although some of those states are of a short enough duration to be considered as marking points in time this is no more than co-incidence.

The Repeating Pattern of Seasons.

In the Western calendar there is an arbitrarily labelled set of months, each with a set of days numbered from the first to the last. These months are then arbitrarily imposed onto the four seasons each of which is declared to have particular qualities and each of which is then expected to begin on the first day of a particular month⁷. None of this has any relevance to the Yolŋu who observe the successive states of the climate around them, identify particular states with other

⁶ One example of the way in which a new element can be included without distortion of the overall drama came from a story told by one older man of an experience he had. This had, so he said, coincided with the crying of the rooster. I checked to see whether he was referring to the crying of the jungle fowl (sometimes given the same name), but not so, he had chosen a time event based on the introduced bird so that he could locate his experience in relation to a time event with which he felt I would be familiar.

⁷ I have assumed that in the earlier stages of our Western calendar's development, the two cycles were independent of each other and that the seasons were identified by associated changes in the climate.

concurrent natural features and thus establish a set of categories that are related to the climate and always know which season they are in. One group of informants described seven such "seasons" in Arnhem Land, their version of these being as shown in Table 6.3.

An alternative version given to me by Galpagalpa 1, included *mayaltha* as the first section of *midawarr* and in its place substituted a different category *bärramirriy*, which he termed as being a period of strong west winds and continuous rains that make the country boggy (see Table 6.4). Lowe (n.d.) lists *bärramirri* as a season before the wet season and lists *mayaltha* as a separate season approximately in the same sequential order as I have it listed. When these different observations are compared, it can be seen that the list supplied by Galpagalpa, contains the whole of the group's list in the same sequence, except that his list adds *Bärramirriy*, the time of the strong west wind, after the wet season while Lowe lists it as being before the wet season, and his list incorporates *mayaltha* within *midawarr*. The winds described as blowing during particular seasons are in general terms the same in both lists, although Galpagalpa's list appears to be both more comprehensive and more precise. The only significant differences between the two lists in this regard being in the descriptions of the winds that blow through *Gunmul*. So it would appear that while there are minor variations between informants in the use of categories and sub-categories, the major details vary little.

Significantly each of the eight terms that I have listed were described with the same characteristics by all informants with again the only real differences being in the description of *Gunmul*. As to how many seasons there are in the Yolŋu calendar, there appear to be no absolute answers.⁸

⁸ Davis (1989) has listed 6 seasons as if these are agreed to by all Yolŋu.

Season.	Description of Characteristics
<i>gunmul</i>	which is characterised by "the big Rains". Winds at first are from the west, then as the season progresses, they gradually turn to the south and southeast.
<i>mayaltha</i>	is alternatively called <i>marrayalngi</i> (lit. leaf soft) and <i>mayayalngi</i> . There are new soft leaves on root foods, trees and grass. There is also a great scarcity of vegetable foods.
<i>midawarr</i>	has skies filled with beautiful clouds. The winds are mild, predominantly from the east and north though sometimes there are days without wind at all. The last scraps of rain come with the northeast and east winds (<i>midawarr</i>).
<i>dharratharra</i>	has cold weather with south-easterly wind and very occasionally rain. Root foods are still available but leaves have shrivelled.
<i>rarrandharr</i>	is identified by hot earth when the feet feel as if they are burning. There is now little or no water in the bush away from the permanent waterholes. There are some light breezes from the east but predominantly from the north, northwest or west. Vegetable foods are now available from the billabongs but are mostly finished in the bush. Native bees' hives are now productive.
<i>wulmamirr</i>	(lit. thunder having), is hot and very humid. Early morning breezes are from the south though through the day there may be light breezes from the north, northwest or west. From the islands off the north coast, big clouds are seen standing in the south, lightning is seen flashing in them. There may be electrical storms.
<i>dhuludur</i>	sees the first rain falls followed by a brief dry period. There may be winds from the south. The first fruit forms and ripens as soon as the rain falls. The grass shoots green again.

Table 6.3. One version of the sequence of season terms in Arnhem Land.

It seems to be common for an English speaker to see the calendar year as having a beginning and an end, to list off the months commencing from January, and the seasons starting with Spring. In contrast to this when Yolŋu list off the seasons it appears normal to commence from the season currently being experienced and then to continue to the end of the cycle. The sequence of the seasons together with the approximate relation between these classifications, and the Western calendar are shown in Figure 6.2.

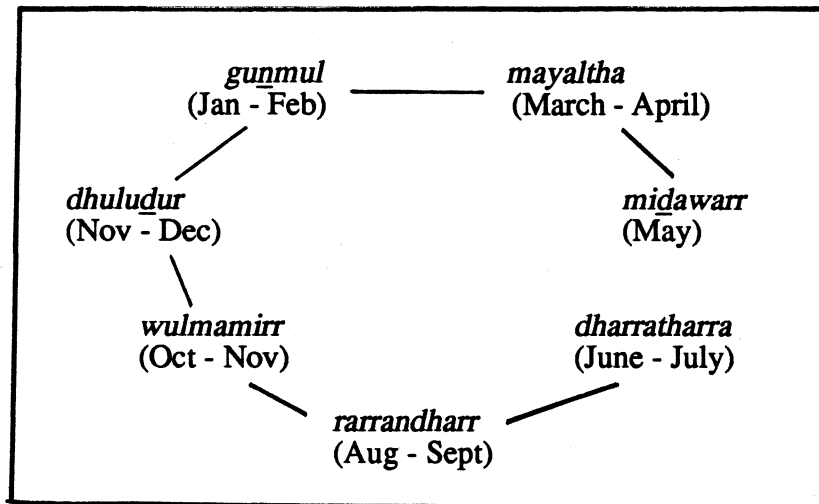

Figure 6.2. Relation between Yolŋu and Western calendar terms.

In addition to identifying the climatic features as the basic characteristics of each season the Yolŋu frequently refer to the relationships between the season and the cyclical patterns of the growth of the different natural species. That is, they comment on what they see as natural signs in the environment which give an indication of what various natural species can be expected to be doing concurrently. For example, when the *gadayka* (stringy bark trees) are in flower is the time when *mattjurr* (the flying fox) can be expected to be available in abundance for hunting; similarly, when you see that the *dhanggi* and *balgurr* trees are in flower you can expect to see *ganguri* (a yam) putting out new leaves, but one can also expect to be able to find young *maranydjalk* (sting rays and sharks) close to the shore, and that they will be very sweet (rich in fat) at that time. It is the concurrence of such events which forms the set of qualities by which a season is marked.

Some of these relationships were listed off for me by Galpagalpa as mentioned earlier in association with the different sections of each season. In doing this he associated together the section of the season, the particular wind that could be expected at that time, the growth patterns to be noticed in the plants and the

particular attributes of the land, and sea creatures and birds that were relevant to that particular classification of the year. This set of observations and expectations is listed in tabulated form in Table 6.4.

Other Repeating Patterns of Temporal Locations

In addition to the two above sets of terms there are a number of classifications used to identify other events which overlap with those of the twenty-four hour and seasonal patterns. These refer to lunar stages, the movements of tides, or of stars and stellar constellations.

Associated with the Moon.

The movements of the moon and its waxing and waning are recognised as belonging to a different sequence of events from either the day or the seasons, and at least some of the senior generation are aware of relationships between moon and tides. I was told by one man that when the new moon was in "that" position in the sky (about three quarters of the way from east to west) at dawn, then it was the time of the neap tides, and someone else indicated that when the full moon is large and close to the tree tops, the tide will be coming in. The position of the moon in the night sky may be used as a basis for indicating a particular temporal location by such terms as the following,

<i>ŋalindi-walmanharay</i>	= moonrise. (lit. moon comes out).
<i>ŋalindi-gärrinyaray</i>	= moon setting (lit. moon going in).
<i>ŋalindi-djalkiri-bandanydhinyaray</i>	= moon overhead (lit. moon feet become dry).

There are separate names for the moon in its different phases. The new moon is called *likan* or *nongurr* (which are both terms for "elbow") or it may simply be called *yuta* (new) with the connotation of young. *Birku* is the full moon

Season	Wind	Plants	Other Features
Midawarr	<i>makarr lungurra</i> (north wind) (<i>midawarr nyumukuniny</i>) <i>midawarr dumurrupu</i> (northeast wind) <i>makarr midawarr</i> (northeast wind)	<i>marra yalngi/mayaltha</i> (leaves soft) <i>ŋatha daw'yunaray</i> (plant food broken) <i>ŋatha galadar'yunaray</i> (yam leaves changed colour) <i>ŋatha daw'yunaray</i> (plant food broken) <i>ganguri</i> and <i>djitama</i> ready to dig.	People feel good think about fishing or turtle hunting Pelican and pied goose eggs ready to gather Djulpan in sky Ground hard for digging
Dharratharra	<i>dharratharra / wädut</i> (cold strong wind from the east) <i>ritji / mondulmirriy / biyamar</i> (wind from the east that builds up big waves) <i>madirri / munungarri</i> (wind from southeast that breaks trees)	<i>murruga</i> and <i>bananak</i> in flower <i>genydja</i> in flower <i>genydja</i> in fruit	pelicans and terns nesting on the beaches
Rarrandharr nyumukuniny Rarrandharr yindi Makarr rarrandharr (Luku-nhärhanmirri)	<i>Nälamaya</i> (a north-west wind) blows right throughout the season	scattered <i>gadayka</i> flowers Vegetable foods in billabongs becoming available. <i>gadayka</i> fully in flower <i>dhanggi</i> and <i>balgurr</i> flowers trees and <i>ganguri</i> put out new leaves	<i>guku</i> (honey) and <i>mattjurr</i> (flying fox) young <i>maranydjalk djukurmirri</i> (stingrays have fat) Water dried right out.
Wolmamirriy	<i>Lungurra</i> (big wind from the north).	<i>minyawuru</i> and <i>balkpalk</i> seed pods opening	Tides go far out big clouds standing over the mainland. Thunder
Dhuludur	<i>Djalathap</i> (south wind). <i>Rekay</i> (Wind from SE by S) <i>Rarrangal</i> (Wind from SE by W)	Flowers on <i>walan</i> . Grass shoots green again. <i>Balarrwalarr</i> flowers open Fruit ripen on <i>munydjutj</i> , <i>dangapa</i> , <i>wundan</i> and mango.	First rains fall then a gap after them. <i>Gartjambal</i> and <i>Wurpan</i> . (Kangaroo and Emu)
Gunmul	<i>Djalathap</i> (south wind) <i>Lungurra</i> (North wind) <i>Nälamaya / Lirra-ŋän'ka</i> (Northwest wind)	<i>warraga</i> in all stages of ripening <i>duyŋa</i> eaten	big clouds without thunder then rain more young <i>maranydjalk</i>
Bärramirriy	<i>Bärra/wuŋ'kurmirriy</i> (Strong west wind).	Flowers on <i>gumbu</i> , <i>dilminyin</i> , <i>biyawilitj</i> , <i>yalman</i> Then fruit. <i>Boluku</i> of cycad	

Table 6.4. Relationships between seasons and cycles of nature.

moon. One explains how it returns to the east during the day by transforming into a parrot fish when it goes down in the west. It then swims back ready for the next night. The other myth explains not only the origin of the moon, but also of its repeated pattern of waxing and waning

Nalindi (moon) was, at the beginning, an Aboriginal man who sat making a woven fish trap while his sons went hunting for food. On their return they ate the results of their hunting in front of him but gave him nothing. This made *Nalindi* extremely angry. He tricked the boys into climbing inside the fish trap, ostensibly to test it for him. When they were inside, he tied it shut, beat them to death and threw the trap with the bodies inside, into the water hole. His wives, on returning from hunting inquired of the boy's whereabouts and were told by *Nalindi* that he knew nothing about them. Eventually the wives discovered the bodies, and waited for the right opportunity for revenge. When *Nalindi* was asleep in their hut they built a large fire and burned him to death. As he was dying he rose up into the sky, becoming the moon as he did so and calling out that they would die, but he would keep coming back.

It is in the terms of this latter myth that when the last phase of the moon, called *werr*, is described, it is spoken of in terms of "getting sick and thin" or "he is close to dying".

The Tides and Tidal Currents.

I was not able to investigate the perceived relationships between the moon and the tides, but the ebb and flow of the tides and sea currents is well known and the patterns of tidal flows along the Arnhem Land Coastline are used both for travelling by canoe and as analogues of the relationships between different groups whose land is linked by their flow. No-one would think of making a canoe journey in a direction that was opposite the direction of the tidal flow, but would wait until the currents turned in the direction that they wanted to go.⁹ Some of the major currents were drawn for me on maps of the coastline (see Map 6.1). Each of

⁹ With the advent of power boats the use of such currents appears to be a practice no longer relevant, though the knowledge of them continues with some at least being enshrined in the song cycles.

these currents was drawn by a person from a Yirritja moiety clan and I did not discover any such currents relating to Dhuwa clans, though this may well have been circumstantial.

The movements of the tides out and in are of great importance to the coastal clans. They affect both the men's hunting of fish and marine creatures and the women's gathering of shellfish. The present pattern of tidal movements is almost always known, and a number of temporal locations relate to the state of the tide. For example,

<i>rapithinyaray</i>	= low tide. (lit. become beach).
<i>ŋurrithirri</i>	= coming in, of tide.
<i>ŋurru-bilyunaray gapuy</i>	= at the turn of the tide, about to come in.
<i>dhapa-gulkthunaray gapuy</i>	= at the turn of the tide, about to recede.

The Stars.

Only a small number of stars or constellations appear to be named, and all of those for which I found names have either ritual or mythological significance. In amongst the terms listed earlier, associated with the classifications of time at night were a set of terms for events relating to the morning star. There being three successive morning stars, their separate risings and their disappearance are used as temporal locations during the pre-dawn morning. One term was also included in the same lists based on the setting of the evening star.

The Milky Way, *baḍurru*, always visible in some part of the night sky, was the source of only one of the terms I collected, *baḍurru-bilyunaray* (lit. the milky way is turning [just passing zenith]) was only relevant at some times of the year, however I was told in English by one person that "we know the time at night by the position of *baḍurru*".

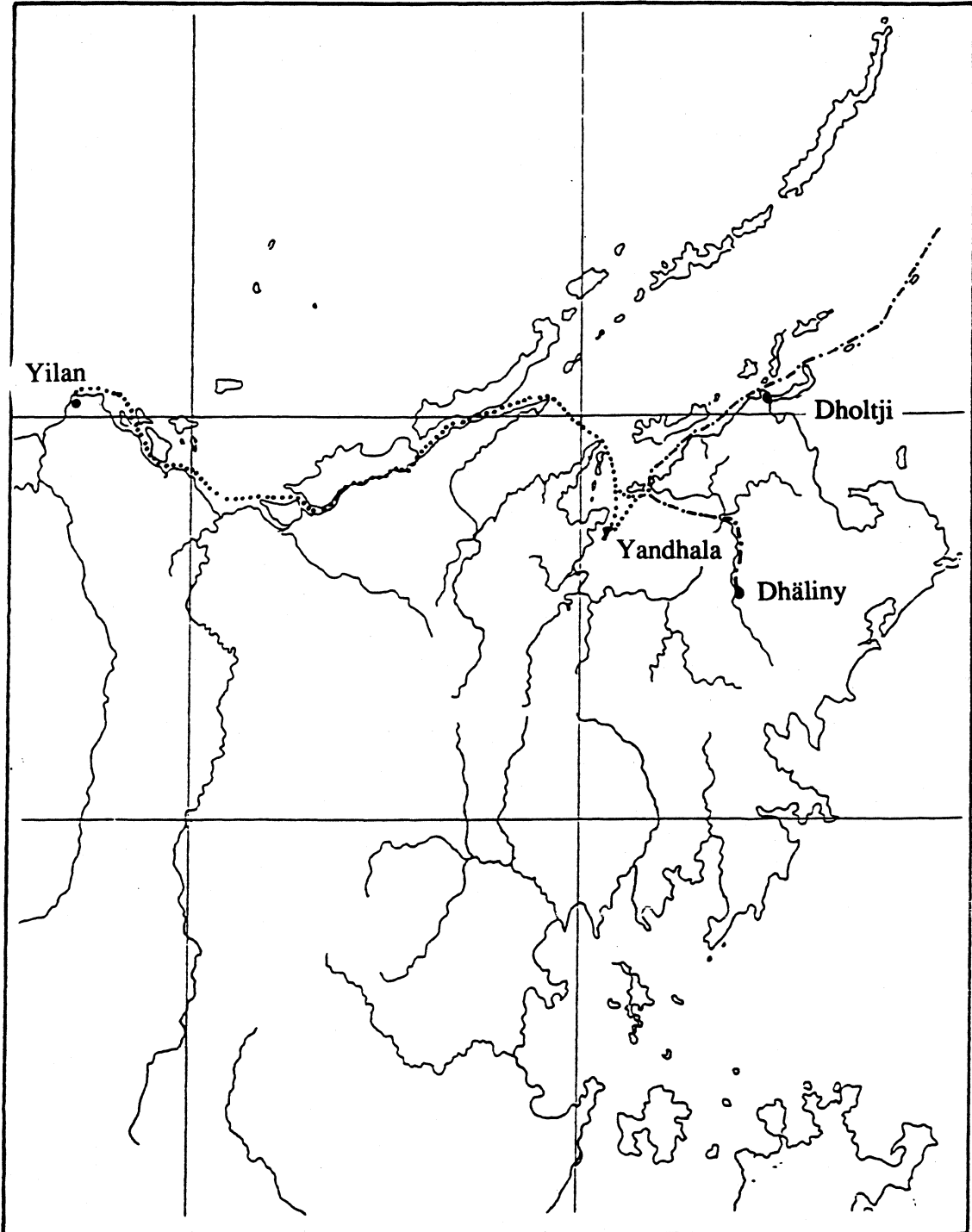

Map 6.1. Some major Arnhem Land marine currents.

..... Gupapuyŋu Current connections.

- . - . - . Wangurri to Warramiri connections.

Indication was given that the Pleiades and Orion's Belt (which together form the constellation *djulpan*) are known to be in the sky at the time when root foods in the bush are becoming available. Similarly *djurrapun* (the Evening Star) was known to indicate that *rākay* (swamp rush corms) were ready and *gurrumattji* (pied goose) could be hunted and their eggs gathered.

Repeating events relating to plants.

In Table 6.4, there were three terms, derived from the development of yam plants, listed as forming successive parts of the season *midawarr*. It was the changes in the plant's appearance, associated with slight changes in the winds which are the indicators of the different categories. The three terms as I was given them and as they are in the table are in the form of temporal classifications and not simply descriptions of plant conditions.

As shown in Table 6.4, it is known which fruits, root foods and flowers are in evidence when, and Table 6.5 (developed from Rudder 1977. 2:2.3.3.) gives an indication of the known availability of root foods in three different ecological zones, showing that most root foods are available for only a limited part of the year. While it would be a simple matter to refer to "wattle time" or "mango time", it appears that the plant growth stages function more as indicators of which season is manifesting and form then part of the qualitative attributes of the different seasons. Nowhere have I yet found classifications of temporal locations based on plant development stages alone apart from the three terms shown in *midawarr* in Table.6.4. although temporal locations are often given for other events on the basis of concurrent plant growth stages.

Incorporations and Changes since Western Contact.

Both the Western time system and Western culture have had an impact on the perceptions of time in Arnhem Land. This can be seen particularly clearly in

Retjapuy (Jungle Plants)	Midawarr	Rarrandharr	Dhuludur	Waltjan	Mayalŋa
<i>dhum'pana</i>	*				
<i>djirambulk</i>		*			
<i>djitama</i>	*	*	*		
<i>djundatjunda</i>	*	*			
<i>galun</i>		*			
<i>ganguri</i>	*	*	*		
<i>ganima</i>	*	*			
<i>luwiya</i>	*	*			
<i>nhumurray</i>		*			

Diltjipuy (Forest Plants)	Midawarr	Rarrandharr	Dhuludur	Waltjan	Mayalŋa
<i>bäwaŋ</i>	*	*	*		
<i>beyuŋu</i>	*	*	*		
<i>butjuwutju</i>	*	*	*		
<i>duyŋa</i>	*	*	*		
<i>dhuwudu</i>	*	*	*		
<i>djalpinyŋu</i>	*	*	*		
<i>galun</i>	*	*	*		
<i>ganima</i>	*	*			
<i>golunŋu</i>	*	*	*		
<i>gupuru</i>	*	*	*		
<i>muliyaŋarr</i>	*	*	*		
<i>mona</i>	*	*	*		
<i>riny'tjaŋu</i>	*	*	*		
<i>walaŋari</i>	*	*	*		
<i>warraga</i>	*	*	*	*	*
<i>yukuwa</i>	*	*	*		
<i>yuluk</i>	*	*	*		

Gulunbuy (Swamp Plants)	Midawarr	Rarrandharr	Dhuludur	Waltjan	Mayalŋa
<i>dharrayini</i>	*	*			
<i>dhatam</i>	*	*			
<i>dhandaw</i>	*	*			
<i>dhirraŋ</i>	*	*			
<i>dirpu</i>	*	*	*		
<i>galun</i>	*	*	*		
<i>garku</i>	*	*			
<i>nyamnyam'</i>		*			
<i>ŋarriyal</i>		*			
<i>räkay</i>		*	*		
<i>wakwak</i>	*				

Table 6.5. Seasonal availability of *Natha* (carbohydrate vegetable foods).

terms of increases in vocabulary, through the adaptation of English words to a Yolŋu phonology, and through the development of new terms to meet changed social conditions. There has also been some change wrought in the meanings of a small amount of the original Yolŋu vocabulary when this is used in a non-Yolŋu context.

One group of introduced words is the set of names of the days of the week, which simply adds another sequence of named temporal locations. The pronunciation of these is severely affected by the fact that there are no fricative sounds in Yolŋu languages. As a result of this, and the use of the Yolŋu practical orthography, the names of the days of the week are then as follows,

<i>Djandi</i>	= Sunday	<i>Mandi</i>	= Monday
<i>Djutjthi</i>	= Tuesday	<i>Winitjthi</i>	= Wednesday
<i>Nambatu Brayti</i>	= Thursday	<i>Brayti</i>	= Friday
<i>Djatati</i>	= Saturday.		

Weeks are now also recognised and alternative weeks are identified according to whether there is an income that week or not. This is related to whether it is the fortnight when government cheques arrive or not or whether it is council pay week or not, and the identification can vary from person to person. One elderly Djapu lady, speaking to family on the telephone beside me, contrasted *djirripimirriy* (pension-having time) with *gawundjilwikthu* (lit. council-week time). That is she was making a contrast between the week when council workers were paid and the alternative week when pensions arrived. Others contrast *biny'tjinmirriy* (lit. pension-having time) or *gunda-gurrupanamirriy weyikthu* (lit. stone/coin-giving-having-time week) with *mayala weyikthu* (lit. empty week time). Ross (pre-1977) notes that at Yirrkala, the word *dumurru'ŋuy* (lit. big-from-time) was being used there for "week", and from this had developed a contrast between *dhiyaŋu dumurru'ŋuy* (this week) and *wiripuŋuy dumurru'ŋuy* (next, or another week).

A small amount of Yolŋu vocabulary has absorbed meanings from the context of their nearest English equivalents. *Walu* (sun) has been adapted more than other words discussed in this chapter. Its meaning has now been extended to include "watch", "clock" and "time" in a Western sense. The question can then be asked "Nhã walu?" (What's the time) with the expectation that the answer will identify the present time in hours and minutes. The question itself seems to have developed out of the Western requirement to know what the time is, as there is no likelihood of any Yolŋu not knowing which section of the twenty-four hour cycle he was in. Any person has only to look around them to know. The question word "Nhãtha?" (When?) is used to inquire about non-present time slots.

The Yolŋu word *ŋalindi* has similarly become extended to include the meaning "month". The question "Nhã ŋalindi" (lit. What moon?) has the expectation of an English answer in the form of the name of one of the months. Until Western contact the Yolŋu did not name the months separately and it appears reasonable to assume that these changes have occurred as a result of white members of the community trying to discover the answers to questions of importance to them, but irrelevant to the Yolŋu in any other context.

One other effect of the result of government (including school and hospital) records has been the development of an awareness of dates of birth, and most adults, even if not sure of their own, know that they have one. With the advent of white families and the birthday parties for their children to which Yolŋu children were invited, there have now also begun to be Yolŋu families celebrating their own children's birthdays with parties. There is also some awareness that age, counted by years, is one way of marking the stages in the passage of human life.

CONCEPTUALISATION OF TEMPORAL SPACE AS REFLECTED IN THE LANGUAGE.

Verbs.

Lowe (N.D.) lists what she describes as seven different tenses of the verb in the Gupapuyŋu language. These are distinguished by the use of one of the

Present continuous tense uses the primary form of the verb.	
<i>Nayi ga bathan.</i>	He/she is cooking (it).
<i>Nayi ga roŋiyirri.</i>	He/she is returning.
Same day past uses the tertiary form,	
<i>Nayi bathara.</i>	He/she cooked (it).
<i>Nayi roŋiyina.</i>	He/she returned.
Yesterday past uses the primary form,	
<i>Nayi bathan barpuru.</i>	He/she cooked (it) yesterday.
<i>Nayi roŋiyirri barpuru.</i>	He/she returned yesterday.
Indefinite/far distant past uses the tertiary form,	
<i>Nayi bathara.</i>	He/she cooked (it).
<i>Nayi roŋiyina.</i>	He/she returned.
Same day future uses the primary form with future particle,	
<i>Nayi dhu bathan.</i>	He/she will cook (it).
<i>Nayi dhu roŋiyirri.</i>	He/she will return.
Tomorrow future uses the secondary form with the future particle and time classification,	
<i>Godarr' nayi dhu bathulu.</i>	Tomorrow he/she will cook(it).
<i>Godarr' nayi dhu roŋiyi.</i>	Tomorrow he/she will return.
Indefinite/far distant future uses the primary form with the future particle,	
<i>Yalalaŋumirriy nayi dhu bathan.</i>	Later on he/she will cook (it).
<i>Yalalaŋumirriy nayi dhu roŋiyirri.</i>	Later on he/she will return.

Table 6.6. Verb tenses in Gupapuyŋu . (After Lowe.(N.D.)).

four different verb forms (her primary, secondary, tertiary and quaternary) and, by the use of the particles *dhu* (with future) and *ga* (with present). She identifies them by the following terms: present tense, same day past and same day future, tomorrow future (which includes any specified future time), yesterday past (which includes any specifically identified past event), and finally far distant past and far distant future. Examples of the uses of these seven tenses are as in Table 6.6.

When these "tenses" are examined more closely it can be shown that her "same day past" and "far distant past" tenses are identical. Similarly the "same day future" and "far distant future" tenses are also the same as each other. The distinctions being made by the use of these forms cannot then be argued to be related solely to the distance in time from the present. What the contrasts do indicate is a distinction being made between precise and non-precise locations of the event (in relation to the repeating temporal locations) and between actual (present and past) and potential (future) actions. The continuative particle is obligatory in the present, and optional at any other time. In Gupapuyŋu usage then, in the description of any actual (past or present) event in a precisely identified location in time, the primary form of the verb is used (with the continuative particle *ga*, if it was an event which involved duration, and the primary form without any particle if there is no duration indicated, i.e. it is "simple past tense"). For an actual event where there is no identification of a precise location, the tertiary form of the verb is used, and for duration of action, the particle *gana* (a derivative of *ga*) is added. With potential (future) actions, the same contrast is apparent between events where time location was specified (tomorrow future) and events where the time classification was not given (same day, and distant future).

My suggestion then is that while there are two contrasts used in the Gupapuyŋu verbs which are related to location in temporal space, neither contrast is concerned with the distance of time from the present. One is a contrast between

precise and imprecise temporal locations, and the other is a contrast between actual (i.e. the event exists in both space and time) and potential (can come into existence, but hasn't yet). This in turn indicates the importance to the Yolŋu two types of contrast.

My analysis of the verb forms is illustrated in Table 6.7. The two levels of the figure are significant, particularly in regard to understanding usage and its perceptual framework. They also give some indication of the low level of importance placed on precision in locating events in time.

Indefinite Past <i>bathara</i> (eventuated)	Definite Present <i>ga bathan</i> (eventing)			Indefinite Future <i>dhu bathan</i> (unevented)
Indefinite Past <i>bathara</i> (eventuated)	Definite Past <i>bathan ± ga</i> (eventuated)	Definite Present <i>bathan + ga</i> (eventing)	Definite Future <i>bathulu ± ga</i> (unevented)	Indefinite Future <i>dhu bathan</i> (unevented)

Table 6.7. Relationships between Verb Forms and Temporal Locations.

The upper level of the figure is concerned with the normal, everyday useage of the language. It shows first a contrast between present, (and hence a definite temporal location), and non-present indefinite location. Secondly there is a contrast shown between events which are future and hence potential, and those which are present or past and hence have become actuated.

The lower level of the figure illustrates what happens when the temporal location of a non-present event has significance. When this happens, a definite temporal location is given and the action, whether actual or potential, is referred to using a different verb form from that used for an indefinite location.

The Demonstratives.

The demonstratives shown in Table 6.8, combine aspects of both temporal and geographic space location, contrasting close proximity with distance, precision with imprecision in location, and present location with non-present

	here, close definite	there, close definite	there, other definite	there, other indefinite
then non-present time	<i>dhiyala</i> (Gup) <i>dhiyal</i> (Djam)	<i>dhiyali</i> (Gup) <i>dhiyali</i> (Djam)	<i>ḡunhala</i> (Gup) <i>ḡunhal</i> (Djam)	<i>ḡunhili</i> (Gup) <i>ḡunhi</i> (Djam)
now, present time	<i>dhuwala</i> (Gup) <i>dhuwal</i> (Djam)	<i>dhuwali</i> (Gup) <i>dhuwal</i> (Djam)	<i>ḡunha</i> (Gup) <i>ḡunha</i> (Djam)	<i>ḡunhi</i> (Gup) <i>ḡunhi</i> (Djam)

Table 6.8. Relationships between Demonstratives and Time Locations.

location. One set of four terms refers to the four spatial locations in present time, and the other set to the same set of spatial location in non-present time. The latter set retain the same form whether the temporal location is precisely determined or not and whether it is actual or potential. I have included in the figure examples from both Djambarrpuyŋu and Gupapuyŋu languages as an indication that these same contrasts are probably consistent across a number of languages among the Yolŋu peoples¹⁰.

The Construction of the Terminology of Temporal Location.

Lowe (N.D. Lesson 81) lists a number of words which she describes as "derived words, adverbs of time", saying that these are developed by the

¹⁰ F.Morphy (1983:57,59 and 101) referring to another Yolŋu language, Djapu, notes this same contrast in form between present and non-present event reference in the demonstratives.

addition of the instrument/action suffix -dhu, -thu, -yu, -y.¹¹ Some of these are described as being constructed from verbs. For example, *bongama* = break (of day), becomes *bonganharay* = at day break, at dawn, by the addition of an action or instrument suffix (-y) to the quaternary form of the verb (*bonganha +ra*). Similarly *gurru-bilyunaraygapuy* (at the turn of the tide about to come in) is derived in literal terms from, nose-turning+(-y) water+(-y). A larger selection of derived terms of both these types is included in Tables 6.1 and 6.2. In this way time expressions can be developed from the nominalised form of the verb with the "instrument/action" suffix added to produce a name for a temporal location.

In the list of terms given earlier, and the accompanying Figures 6.1 and 6.3, there is a combination of what appear to be descriptive terms and terms that have been listed as temporal locations. These are recorded as they were collected during discussions of the cycles of the day and the seasons. As they were spoken out, they were in this mixture of forms. It appears that when the particular period is being discussed it will be given its name or descriptive term, but when this is used as a specific reference to the time location when some other event occurs, the -y suffix is used, to indicate that that is the temporal location.

Temporal Words and the Structure of Descriptive Terms.

There are some temporal locations that are classified by names that are not developed by descriptive means and there are a variety of others that have been developed as qualitative descriptions. Examples of the former are found in Lowe (N.D:Lesson 81) in a list of words which she describes as "pure adverbs of time" as follows,

¹¹ The form of the suffix used is relative to the final sound of the word to which it is attached. If the word ends in a vowel the suffix is "-y".

<i>barpuru</i>	= yesterday
<i>gāthura</i>	= today, just now,
<i>godarr'</i>	= morning, in the morning
<i>gunburrku</i>	= in the middle of the night, late at night,
<i>yalala</i>	= later on,

Her list is not exhaustive, and many other such words have already been listed earlier in this chapter. In the preceding section I showed how a distinction can be made between the form of words used as names for temporal locations, and their form when used with the -dhu, -thu-, -yu, -y, suffix to indicate location of another event in conjunction with them. In other cases, use may be made of some feature of the period during which an action occurs, like the name of the wind which is blowing, such as *bārra*, the west wind. To this is then added the suffix *-mirri* (having or possessing) to produce a qualitative expression so that *bārra* becomes *bārramirri* (having the west wind). With the addition of the additional suffix *-y* this then becomes the name of one of the seasons, *Bārramirriy* (at the period having the west wind) or an event locating term. A number of such terms have already been listed which incorporate the suffix, *-mirri*, and there appears to be no limit for the potential use of this construction. For example, "during the wet season" can be *waltjanmirriy* (at the period rain-having) and "at Christmas" is now *Christmasmirriy* (at the period Christmas-having).

When the name for a temporal location is combined with a demonstrative or developed from a demonstrative by using the -dhu, -thu-, -yu, -y, suffix, such expressions are developed as,

<i>dhiyaŋu bala waluy</i>	= this day / now.
<i>dhiyaŋu waltjandhu</i>	= this year / wet season
<i>wiripuyuy waluy</i>	= another day.

The use of such expressions is discussed in the next section.

DISTANCE IN TEMPORAL SPACE.

Distance in temporal space is indicated not by referring to a measurement of time, but to the location in temporal space of the event under discussion. This as I have shown up to this point is achieved in a number of ways. These included the identification of locations contained in specific classifications, a number of terms that indicate proximity or absence in temporal space, and a contrast was shown in the demonstratives, which lies between present and non-present locations, and finally a contrast was demonstrated in the verbs between precise and non-precise location of events. I move now to the consideration of terminology associated more strictly with distance from the present.

In the preceding section I noted the terms *barpuru* (yesterday), *gāthura* (today), *godarr* (in the morning/tomorrow) and *yalala* (later) without making comment that these are not so much references to location in the relation to repeating temporal events, as to location relative to today. None of them, apart from *gāthura*, is used to refer strictly to an exact location but to a generalisation of within a day (or other category) or two. Other terms referring to position relative to the present are developed by using the demonstratives, "this" and "other" in conjunction with time location terms. For example, *dhiyaŋu bala waluy* (this day / now), *dhiyaŋu waltjandhu* (this year / wet season) and *wiripuŋuy waluy* (another day). These are used at both the level of the day's events and at the level of the seasons to extend the locations beyond the current event.

Two sets of terms are associated with distance from the present, developed from the words *galki* (close) and *barrku* (far) using the modifiers *mārr* (moderately) and *mirithirri* (extremely) and all of the terms used are relative ones. These are used to refer to distance in either geographic or temporal space, forming sets of terms such as, *galki* (close/soon), *mārr galki* (fairly soon/fairly close) and *mirithirr galki* (very close/very soon). The second set, referring to specifically to

events of the near past can be referred to as *barpuru* (yesterday or yesterdayish) *märr barpuru* (moderately yesterday/in the last few days) (Buchanan 1991). Alternatively the events can be treated as either, being in imprecise temporal locations, or else located using one of the words from the sets of repeating terms.

Beyond the distance able to be referred to by these terms an event is located by one of three methods. The first of these uses the terms for imprecise far distance in time, *baman'* (long ago) or *baman'birr'* (extremely long ago). The second method allocates an event as being in relation to one of a series of events of major significance in either historical or religious terms, or a combination of the two. These, not listed in strict sequence, are as follows,

Maŋgatharramirriy	= during the time that the Macassans came on regular visits.
Womirriy	= during World War II
Mitjinmirriy	= during the time when the Arnhem Land towns were missions staffed by missionaries.
Revivalmirriy	= during the initial period of the Arnhem Land Revival, or at one of the subsequent Annual Revival Thanksgiving rallies.

It appears possible to also speak of events as being concurrent with the journeys of the ancestral beings. For example they could be spoken of as concurrent with the time of the Djaŋ'kawu or the Wäwilak, or of Barama and Lany'tjun, and both Morphy (1984:17) and Williams (1986:28) refer to a sort of location in the distant past which was Waŋarr (Creative Ancestor) time which these authors consider as being a sort of creation period into which all these creative beings have been incorporated. I made no record of any reference to such an overall category, but there would be no difficulty in using such a term and no conflict between it and my own observations, as it is with this connotation that I have observed the two terms for imprecise far distance in time being used.

The third method which can be used to locate events at a distance relates an event to the history of individuals. This could be a reference to something that happened during the life of a living person or of a deceased relative. It can simply be a reference to that person's lifetime as a whole, as for example, I was told that the *mälk* (subsection) system was brought to the coastal people by a man's grandfather when the same man brought the Gunapipi ceremony. Alternatively, a reference may be made to an event occurring at or after a significant ceremonial event in a person's lifetime. For example, a man may speak of his seeing certain items first at his circumcision ceremony.¹²

There is in the use of such life stage categories to locate events, the awareness that there is a succession of temporal locations, but it is the location of events in relation to the life stages which appears to be the focus of attention, with the distance from the present a peripheral aspect of the location, and the continuum aspect of time, irrelevant.

When each of the sets of terms and the different approaches to temporal locations are juxtaposed on a graph which represents a continuum, some interesting aspects become apparent. Figure 6.3 gives an indication of the kinds of location that can be relevant in the succession of events in a family's history. In this figure the word *ŋunhi* has been rendered as "when", but could equally be rendered as "where" or as "at that space" (As shown in Table 6.8). This appears to be unlikely for such a sequence of events to be extended more than one generation into the future or more than two into the past, so that the precise location of events in temporal distance is relevant in this context within the period of living memory, but beyond that is irrelevant and hence imprecise. Occasionally an event will be said to have occurred during the lifetime of the founder of a clan, however this is not common, and when it does occur, it belongs to the mythological end of the

¹² Geertz (1966:420) claims that how one views the process of biological aging profoundly affects how one experiences time, suggesting that there is an unbreakable link between the "conception of what it is to be a person and their conception of the structure of history"

continuum rather than being a reference to a precise location. In terms of the future there is at most the possibility of potential location one generation ahead.

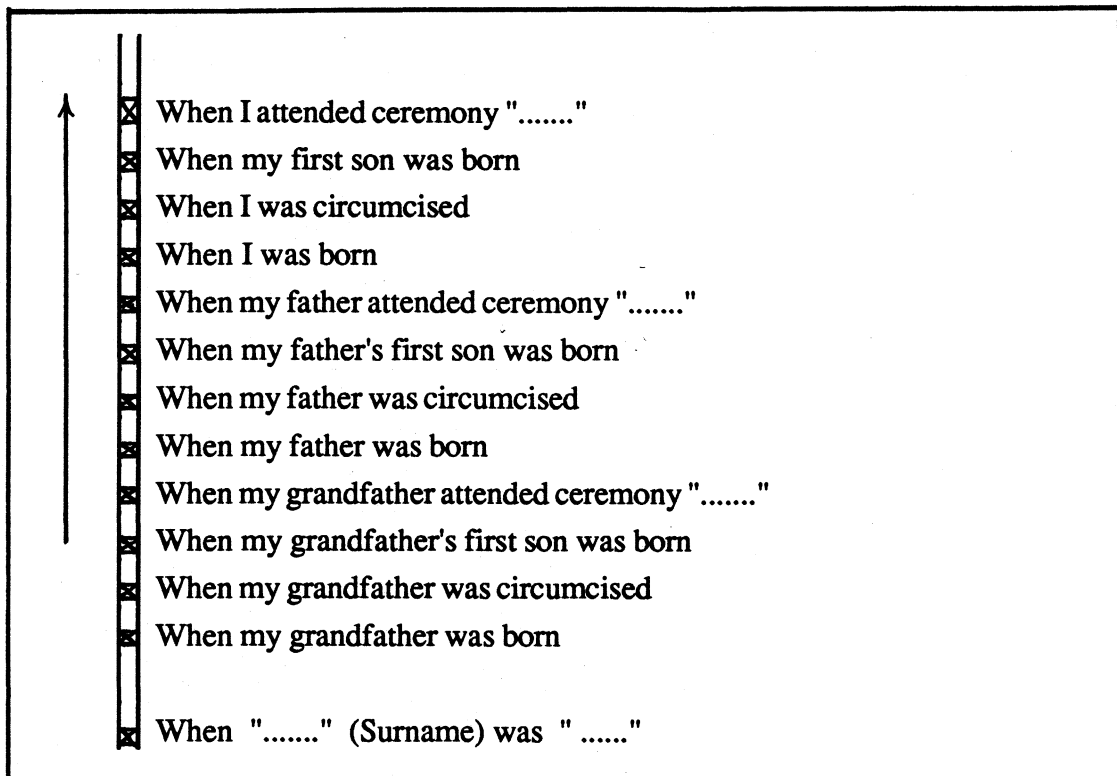

Figure 6.3. Succession of temporal locations based on Family Events.

Figure 6.4 shows that the potential for locating events with precision in terms of seasons is limited to the current year and to the season with the same name in either the previous or the following year. Beyond that there is really only capacity for imprecision in time allocation. If the term *dhungarra* (year) is used, events can still only be allocated to this year or other year and beyond that again events can only be imprecisely located. This same pattern applies to the allocation of events to particular days. As shown in Figure 6.5 even if the terms for yesterday, today and tomorrow were able to be used with precision, accurate location of time on a day's scale is available only within the central three days of the time scale and beyond that events are imprecisely located.

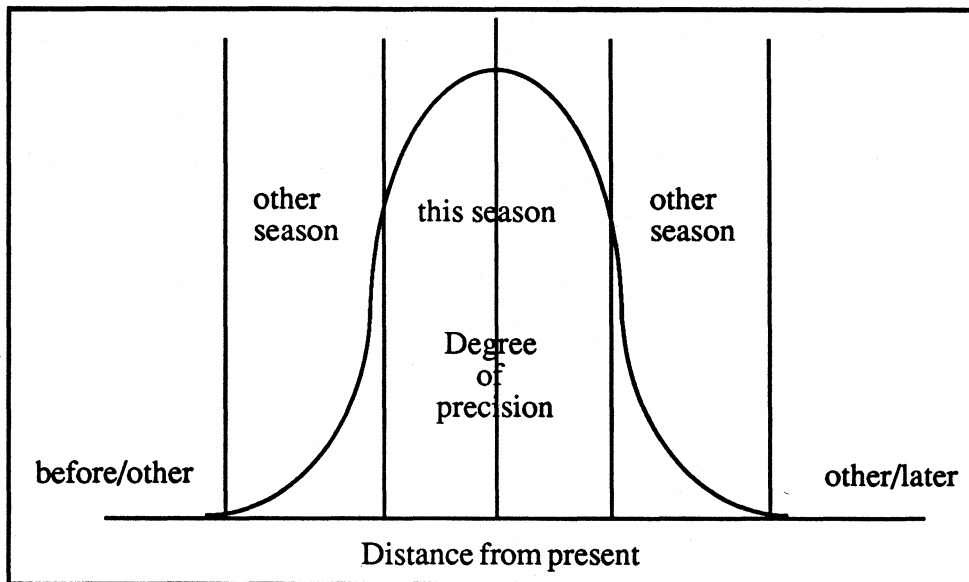

Figure 6.4. Precision of temporal location based on terms for seasons.

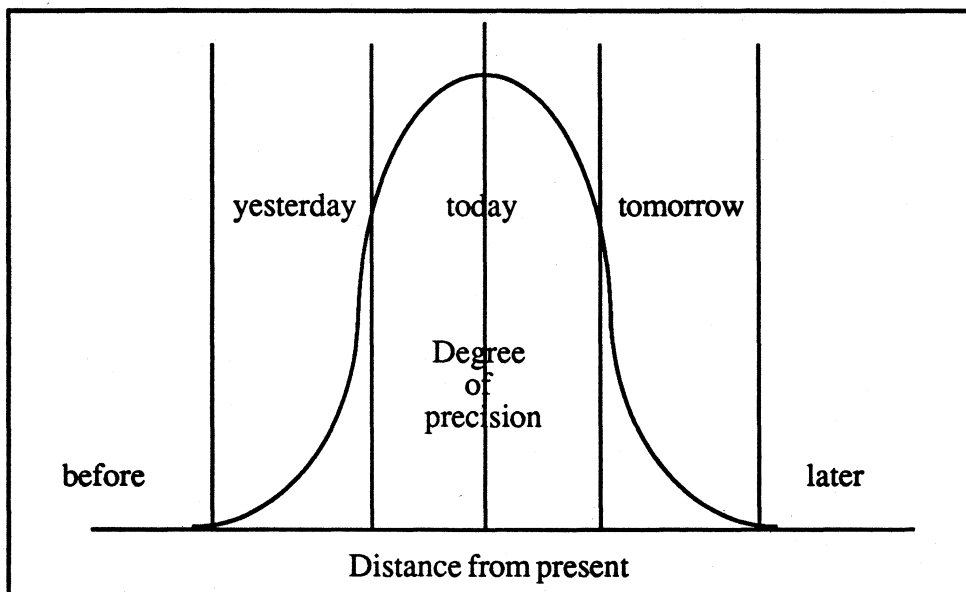

Figure 6.5. Precision of temporal location based on Daily Events.

Whichever of the repeating temporal location systems are used, it appears that there is potential only for the accurate location of events in relation to the current repeating event, or the adjacent ones. Beyond that only imprecise location of events is possible. If the use of the three "number" terms becomes incorporated, the pattern can be extended a little, but in principle remains limited in the same way. That is, events can be located in relation to the present, precisely for a short space on either side of the present, and then beyond that only with imprecision.

One final problem which remains for consideration is that associated with the location of mythological events which, while presented as having occurred in a far distant past, nevertheless have about them a quality that places them also in the "present". These are the events that are often referred to as occurring during "The Dreaming" (e.g. Stanner 1956 and Morphy 1990) or during the "Dreamtime" (e.g. Morphy 1990 and Tonkinson 1974).

When stories of such mythological events are being told by the Yolŋu, the verbs that are used in the narration appear to inevitably be in the "indefinite past" form, although the geographic location is usually very precisely given. This supports a view that it is the reality of the event and its power which is of significance and not the time of its occurrence. If a Yolŋu person is pressed with questions concerning when an event occurred, the answer will usually be given using the terms for imprecise far distance, *baman'* (long ago) or *baman' birr'* (extremely long ago) or occasionally the word *barrku* (far) will be used in the place of *baman'*. In terms of temporal distance this may refer to an event as close as within the present lifespan, but appears to be frequently interpreted by English speakers as being "during the dreamtime".

I have recorded one such a story couched in mythological terms and given an indefinite temporal location, which appeared to describe events that

occurred in 1942. On the assumption that this is a reasonable interpretation of the story that I was told it would support strongly the fact that in the narration of myth and in the location of mythological events, time is irrelevant and that an event's relationship to the "inside" reality is what is significant.

Morphy (1990:314) argues however that there are two distinct categories of myth which he terms myths of creation and myths of inheritance. He sets these in different time frames, arguing that the latter describe events which occurred in an intermediate time frame between the events of creation and those of the present. The myth to which I am referring would, I suspect, be one that he would describe as a myth of inheritance. I have no argument with his classification of two kinds of myth, but suggest that the Yolŋu, in telling them, do not set them in different time frames, as the time frame, while it may be recognised by the Yolŋu is, as I have just suggested, treated by them as being irrelevant.

I have argued also in an earlier chapter that the type of myth described by Morphy as a myth of creation, appears to be concerned with the creation of the sacredness of some element of the landscape, or the creation of sacred objects that are frequently in the form of natural species. It is not the timing of such an event which is important, but its reality, its power and its geographic setting. This second kind of myth is therefore not concerned with the creation of geographic features at all but with the revelation of their sacredness, couched in the terminology of creation. My argument here is that something altogether different from a time setting is involved in both of the kinds of myths classified by Morphy.

As I have shown in earlier chapters, the events described in mythical terms can be considered as "outside" or public stories, each of which has analogically carried meanings that refer to things of an "inside" private, secret, or sacred nature. These narratives then are concerned with events thought of as having to do with the unchanging "inside" reality, its identification, expression or

revelation. Because this is unchanging, time is irrelevant, and could even be argued to be non-existent where these events are concerned. Such an event when it occurs is simply an "outside" manifestation of something beyond time. The Yolŋu philosophy of changelessness is nowhere more active than in such a situation. The description of such an event is then the description of an event of a totally different kind from everyday actions, usually anchored to a particular location but having to do with reality, not time and it is the location of the event geographically and in relation to the "inside" which is significant. Any emphasis of distance then becomes an emphasis on significance, authority and power, not its temporal location. If one can draw a distinction between "eternal" as qualitative and "everlasting" as quantitative evaluations of time, then the Yolŋu have focussed on eternal time as expressing that quality or state of existence which is real but timeless. It is this distinction that Stanner (1972:267-277) has sought to make with his use of the term "the everywhen", and of "the Dreaming" in contrast to "the Dreamtime".

CONCLUSION.

I have sought in this chapter to consider the contrasts between the Yolŋu conceptualisation of and approach to temporal location, and some of the more general aspects of Western perceptions of time. Three different types of location have been identified in the process of discussion; locations related to repeating events, location of events in relationship to the transformations occurring during the lifetime of humans, plants or animals, and finally location of events of mythological significance in relation to the inside of reality.

Repeating events as I have described them are concerned with those events which occur in regularly repeating sequences such as periods of the day, seasons of the year, and movements of the moon, stars and tides. I have shown that the Yolŋu use these to express two separate aspects of time. First to locate an event

in relation to a section of the current sequence, or the sequence on either side of it, or to locate an event imprecisely as "the other" (day, season, tide, etc.). The second aspect of this is that used in this way, the same locating gives an indication of distance from the present. However, as indicated in the discussion of Figures 6.8 and 6.9, both location and distance are only precise in the current sequence, approximate in the sequences either side, and totally imprecise beyond that.

Yolŋu basically classify out the continuum time by establishing the location of an event as occurring in relation to one of the sets of repeating sequential events as described above, or in relation to a particular stage in the life of a known person. The continuum of time is almost totally irrelevant and I have suggested that beyond two generations there is little likelihood of the precise location of any event. All events beyond such precise location are treated as occurring in what I have described as "indefinite time". Within past "indefinite" time I have shown that there have been a number of major epochs established, such as Mangatharramirriy and Womirriy. The sequential relationship between these epochs becomes increasingly blurred the more distant they become from living memory. One result of this is that the more distant any epoch becomes, the more it tends to overlap into the third type of time, that is mythological time.

I have argued that events seen as having mythical or historical significance are not in fact given a temporal classification or a location in distance at all, other than "far distant". These, and events beyond living memory but still retained as part of the Yolŋu corporate experience, go through a change. They become transformed to a qualitative state of unchanging existence that can best be described as eternal, in contrast to everlasting.

Because of the Yolŋu focus on location of events in temporal space as opposed to any consideration of a continuum of time, such events, although they retain some flavour of having occurred in the past, become located in a different

reality. I have argued in earlier chapters that events of this kind are seen by the Yolŋu as part of the unchanging inside of reality. That which has been experienced by them, being thought of as having gone back to what the Yolŋu describe as *djinawa* (inside). Because it is common to refer to this "inside" as inside water, or inside the earth, (where a body is put at death when the person goes inside after death), it is common for such an interpretation to be spoken of as if it was a literal place and each group has its own clan site as the focus of this entry point. For example (Morphy 1990:314) refers to a Yolŋu model of the ancestral beings returning into the ground and of a relationship between humans, "and beings of the ancestral 'past' and of the below-the-ground present".

If my argument is correct, the Yolŋu are not speaking of a physical location at all, but using the physical as an analogue of a spiritual reality, although these are, as mentioned above, given a physical location. This being so, events of a mythological nature, irrespective of their antiquity, almost completely cease to be events in time at all. By becoming part of the inside, they are then part of the unchanging eternal which is past, present and future. Having been expressed once physically gives the event a location in "indefinite" temporal space and precise geographic space, but having become part of the mythological inner reality it is also timeless. It is from this that the ambiguous quality of such events arises and it is this that has resulted in the white Australian's mystical concept of "The Dreamtime".

CHAPTER 7. BANUMBIRR : THE COSMOS PORTRAYED.

INTRODUCTION.

THE NAYMIL FOCUS.

Story of Banumbirr as told by Wadaymu.

A bark painting of Banumbirr, by Wadaymu.

The Story of the Fish, Warrukay. Multiple Meanings.

THE GAPINY GROUP'S PERSPECTIVE.

Banumbirr and Title Claims.

Relations between clans.

Concerning Birth and Death.

OUTWARD CONNECTIONS THROUGH BANUMBIRR.

Gälpu Perspectives.

Djambarrpuyngu ideas of the various types of Banumbirr.

Djapu Connections.

Rirratjingu ideas about Banumbirr.

Clans Linked by Banumbirr.

NARRATIVE VERSIONS.

CONCLUSION.

BANUMBIRR : THE COSMOS PORTRAYED.

INTRODUCTION.

There is as I have shown in the previous chapters a great complexity and diversity in the Yolŋu portrayal of the Cosmos. There are many ceremonial complexes, and an apparent multiplicity of messages being communicated through the various forms used. I have very briefly indicated that there are in any such complex, messages communicated about such primary concerns as the nature of man, the nature of the world, sexuality, life, procreation birth and death. There are also portrayed within any complex, connections between clans and land, relationships between clans, links to other ceremonial complexes, and with all these are discriminations which reinforce the individual identities of clans, and corporately held elements that emphasise group solidarity. I have argued that through all these it is the nature of information held in analogue that enables the release or restriction of the flow of knowledge, and that it is also through the information held in analogue that messages about the nature of the cosmos are communicated. In this chapter and in the Conclusion I examine one such ceremonial complex. That is the one associated with the Morning Star¹. In this examination I will demonstrate some of the ways in which information is carried, connections are made, transformations and analogues function and the Cosmos itself is portrayed.

Banumbirr is the name given to the Morning Star that rises from the east in the last stages of night before dawn. It is also the name given to the whole complex network of myth and ritual, meaning and practice, song-poetry and dance, ideas and relationships linked to it. This extensive complex is "owned" by many of the clans of the Dhuwa moiety and spreads over almost the entire north-eastern section of Arnhem Land.

¹The Morning Star is the planet Venus.

In the Elcho Island region and to the east, the Banumbirr complex has as its focus or core, a small set of facts which appear to be agreed upon by at least some of the groups of the Yolŋu involved. That is to say, that for some of the Yolŋu at Elcho there is a corporately accepted core of facts. As one moves out from this focus (either geographically or intellectually), change can and does occur. Towards the geographic edges of this region, even some of the facts which have functioned as the core at Elcho become hazy and begin to change. As ideas and practices are extended beyond the central core of the complex, the network is extended or moved and manipulated by a wide range of group-specific ideas and practices.

The nearest I could come to determining a set of corporately held basic "facts" that was agreed upon by the Gapiny group of clans is as follows;

- a. Banumbirr is the Morning Star which rises in the eastern sky before dawn,
- b. Banumbirr is a made object largely of feathers and string, and in ritual practice Banumbirr may incorporate or be attached to a wooden pole.
- c. The mokuys at Burralku dance the Banumbirr dance each night before it is released to go on its journey across the sky.
- d. Banumbirr is attached to a string which controls its outward flight and by which it is drawn back to Burralku.
- e. In its journey, Banumbirr stops over the territory of each clan which "owns" it.

These central "facts" identify Banumbirr as Banumbirr, form the focus of its identity for the Gapiny group, and appear to be fundamental facts assumed as known when any reference is made to it. The majority of the different groups of Yolŋu at Galiwin'ku, with whom I had contact, appeared to accept these "facts", irrespective of any additional details that a different group might add to them. These facts thus serve to establish a focus for intergroup agreement and intergroup relationships. Nevertheless there is no single "true" version of the myth, and each performance, whether this be of myth, song, painting, dance or the construction of a

ceremonial object is, at the time of its production, considered to be correct by those responsible for the performance. It also appears inevitable that some other observers will criticise details of the performance, usually out of hearing of the performing group, in ways that demonstrate their own superior knowledge and the performers' ignorance.

Corporately agreed upon separate ownership of Banumbirr by different clans enables each of the owning clans to maintain its relationships with other clans through the complex, while at the same time affirming its own clan variations. The "assumed to be commonly held" core of "facts" functions as a basis to which each separately identified group of people then links their own set of "facts". This pursuit by smaller groups of ideas and practices that are specifically their own, while related to the central "facts", serves to maintain the discrete identity of the smaller groups, and to emphasise that group's particular relationships to other groups and to land and their superior knowledge. This is done in part by emphasising those aspects of Banumbirr that link it to other elements of the group's discrete and separately maintained mythological and ritual elements and hence identity, and by the above-mentioned critical assessment of others.

While the name "Banumbirr" appears to refer to different things in different contexts it is perceived as a single identity with a variety of expressions of that identity. The name then, refers to all expressions simultaneously with only the context discriminating one meaning from another. So, Banumbirr is as mentioned earlier, the name of a number of different things: the Morning Star that indicates that daylight is returning, the myths which purport to explain its origins and nature, songs which tell the same story in Yolŋu poetic form, bark paintings which present these pictorially, ceremonials which dramatise them, and ritual objects which are seen not as representations of, but as a transformation of, the star and as transformations of each other. Each of the linked clans has a slightly different transformation of the various

elements of the complex and each clan claims that their version is the correct one with their particular names for, and transformations of, the items being the focus of their version of the complex.

I present first some of the facts of Banumbirr as they are seen by one man from one clan, Wadaymu, the senior member of the N̄aymil clan at Galiwinku. To this I then add some details supplied by other men from two other closely related clans (Golumala and D̄ätiwuy) which, together with N̄aymil, form what is called Gapiny *mala* (group) a small conglomerate of clans which share a number of ceremonial elements. The name Gapiny for this corporate identity of the three clans appears to be used by most of the men but there is no total agreement as to its validity. One D̄ätiwuy senior clan member was quoted to me as saying that it should only be used to refer to his clan. I use it as it was used by others of the group. Following this discussion of the Gapiny ideas I broaden the examination of the complex to consider links with other clans, relationships between Banumbirr and land ownership, variations in narratives and clan specific transformations together with their significance, and I leave a more comprehensive analysis of the symbolic content to the final chapter of this thesis.

THE N̄AYMIL FOCUS.

The barest outline of the myth, which contains the earlier listed basic facts, describes the manufacture of the Morning Star (as a ceremonial object) by a *mokuy* (dead person or spirit being). Each day before dawn this star is let out from Burralku (its place of manufacture) on a string, and at daylight it is hauled back on the string by a woman who stores it away in her basket where it stays until its next journey. Different aspects of this myth have been made available to me by clan members. These include a recorded narrative and details shared during discussion of bark paintings.

Wadaymu told the Njaimil clan version of Banumbirr for me on tape.²

The story he tells gives some details of the myth but although the narrative is told as the outward journey of the star, the focus is on Banumbirr as a ceremonial object, and concerned with relationships between clans and land. It is a story filled with a profusion of names and alternative names, and the use of the same names for some different locations to the extent that the reader can become quite confused. The paragraphs are numbered only to assist reference to particular aspects of the story³.

Story of Banumbirr as told by Wadaymu.

1. Yes the story is about that place Gundalmirri. At Gundalmirri there was working that spirit being named Goṅ-bilma ["Hand-clapstick" or "Always Singing"]. His other name is Yawulṅura, and the woman's [or his wife's] name is Mälumbu. He was working at that place Gundalmirri making Banumbirr. He was singing, and that singing for Banumbirr spoiled his wife's sleep and she (Mälumbu), was crying because of Banumbirr. Her sleep was spoiled and she was crying for Banumbirr, for its making⁴.

2. All right. Again he cried out sounds while holding it and dancing and shaking his arms. Dhanbul did [Djapu name for that Spirit being]. He made Banumbirr powerful, put everything on the bone/core [string, feathers and paint]. When they were all there on it, he played the didgeridoo. He played at the place named Gundalmirriṅur. [He played the tune] Banumbirr⁵.

3. All right. After that it went quickly and crossed the water there at Gundalmirri and then it stopped at Burralku. From Burralku it looked and saw the place named Mayayikurr and Mayayilka. [That is Bingurpingurr Island].

4. All right. After that it came down, and was travelling through / across the water, and came out here at Wäkurra Island [A Njaimil place]. At Wäkurra it went up above and saw that place called Mayayikurr, [a Djambarrpuyṅu place] and from there it went through the water and came out at Burralku which is close to the islands Njurryurtjurrwuyṅuy and Mayayikurrwuyṅuy near Matamata. There he came out at Mayayikurr and they heard the spirit being's clapsticks, from that spirit being, from Djambarrpuyṅu and Waltjanguṅ Wulwulwuṅ [from the Bottom Djapu clan]. There that spirit being was dancing north wind for the Djambarrpuyṅu people, and there he went up and they saw him go past. He went past and then stopped and danced the feathered string "Mawuka" [which is a yam] and [that other jungle yam called] "Baladay". There they were dancing at Mayayikurr. He, that Njaimil clan Banumbirr went

² He recorded the story in front of his family, but as he said, told it in Djambarrpuyṅu (not his own language) so that it would be easier for me to understand.

³ The full vernacular text is found in Appendix F.

⁴ There were very definite sexual overtones in these last two sentences and at one stage Wadaymu began to giggle about the subtlety of his choice of ambiguous words.

⁵ "dancing" and "playing" are euphemisms for "copulating".

past towards Wākurra. It went down and went under the water and crossed over the water and came out here at Burralku, here at this Burralku on Galiwin'ku, here at the point called Djarraya number two. It came out here. From there he looked to here. "This is my place, Ruypu, [also called] Milwinditja and Gawuypu." He went up at Djoniwuy, that's what he said that spirit being named Banumbirr

5. At that place he sank down through and went under and came out here at Djoni (at Galiwin'ku). At the hill at Djoni he went up then saw that place the small island, come up (above the horizon) and then he looked and saw N̄ngalala, Marrwawurrpa (a Djinaṅ place) that's the specific place name Marrwawurrpa. He saw Luṅurr there. Then he looked and saw that place Gurripa, [a Gamalanga place] all of them those islands, that place Gurripa, Waladaṅun, [Gamalanga country names] That's what he saw, there.

6. All right, from here at Gawuypu, Ruypu, [Galiwin'ku site names]. He stopped here. At Ruypu he coloured the bones/core/earth with ratjpa [haematite iron oxide pigment], Milwinditj Gawuypu [Galiwin'ku alternative names]. Then he thus [spoke] "Yes you and I here will stay, Gunuwaṅa [Murrūnūn clan name] and Bulukmana, Dar'miny, Guwarr'miny, [N̄aymil clan names] Gondarra [Golumala clan surname], is separate, but those two only are first, Bulukmana, and this place Gunuwaṅa. First they two, they two are leaders for here, Gunuwaṅa [Murrūnūn clan] and Bulukmana" [Dhudi-N̄aymil clan]. There he coloured this place with ratjpa [haematite iron oxide pigment] Gawuypu, Ruypu, Milwinditj, Dhaltha, Gundalmirri, Djirritjirri, Djomaṅa. [Likān terms for Nongurr (Gondarra and N̄aymil)]. There from Gundalmirri [close to Gurrumurru] and here at Gundalmirri [at Elcho].

7. All right. From here [Galiwin'ku] he looked at that Murrunga place. He passed through the water, crossing the water called Mirikindi, Maṅaymaṅay, Dhawunuwunu [names for water]. He swam to that place there at Murrunga. He was at Wāladanur (place near Milingimbi) and then from Wāladanur to Murrunga. There he went up. He looked towards Luṅurr, that's the name for the big area at N̄ngalala, Luṅurr is that big place truly. It's truly Luṅurr but Marrwurrpa is the big area there at Marrnhala [close to Rramingining]. That place is Gawuypu [iron oxide like at Galiwin'ku] there. All right.

8. From here [Galiwin'ku] his arms, went in different directions Gawuypuy, Marrnhalay and he went up and one arm went to Luṅurrwuy. His arm from right side went in a different direction. It named the place Marrwurrpa, [belonging to Burarra -marawurrpa people] also named Gunini, Benydjura, Marrawalwa. This is the story concerning Banumbirr. It concerns Banumbirr. That's Banumbirr's story.

9. All right, but it was just the N̄aymil Banumbirr that went. And he stopped there at Gunini, Benydjura, Marrawalpa, Marrawala there. There he stopped N̄aymil and Murrūnūn, N̄aymil and Murrūnūn. That's Murrūnūn Mālarra, and Murrūnūn Gunbirri. This Banumbirnydja stopped Murrūnūn Mālarra, and Murrūnūn Gunbirri, N̄aymil, and from that N̄aymil [place]. And that [one] he Gulmannha stopped, Gunini, Benydjura, Marrwurrpa. There is a pandanus tree standing there. It's the pandanus image (of Banumbirr) there [at Marrwurrpa]. That's the whole of his [details] completed.

In Wadaymu's story it is explicitly stated that this is a made object, Banumbirr being made by Yawuljura at the Naymil clan homeland centre. After construction, or by means of the process of construction, which appears to be the inference here, Banumbirr is made powerful. This seems to indicate an imbuing with a personality, and a life of its own, and by the time the story has reached the end of Paragraph 4, Banumbirr is spoken of as being a *Wajarr* (spirit being). After construction the "made" representation is described as having a wooden core, [a pole] with arms of tasselled strings, and then throughout the rest of the narrative can be interpreted as a spiritual entity which by its journey and actions is establishing relationships between clans. In Paragraph 8 there is indication with the separate travel of the two arms, that there are two sets of sites and clans linked to Elcho Naymil by separate movements of Banumbirr. It is not until the beginning of Paragraph 9 that we discover that this is a Naymil Banumbirr and by implication from that, it is not the only Banumbirr that exists, and it is this that partly explains the separate linkages of clans mentioned in Paragraph 8. They are linked by the separate transferences of separately constructed objects.

On its journey this particular Banumbirr, made at the Naymil place called Gundalmirri is described as linking together the sites and clans that are identified in the story. Apart from the great number of place names used in the story, there are repetitions of some sections. Paragraph 4 is a repetition and extension of Paragraph 3 where the site Wäkurra had been omitted, and the first part of Paragraph 5 repeats the last part of Paragraph 4. All told there are thirty-one place names used and some of these are repeated. In discussion with Wadaymu later, it became apparent that numbers of the names used were alternative names for single sites, and that some were for separate small places within a general area. The question can be asked as to why there are so many names for these places, but the answer appears to be found by recognising that their use is an example that knowledge is property. In the use of all

these names the speaker is giving evidence that not only does he know the story, he knows and has authority to use the other names, a majority of which appear to be ceremonial names. The story then becomes not just a recorded narrative, but a tape recorded document carrying evidence of rights in the land and Wadaymu is using the making of the tape to make an assertion concerning his own authority in relation to the local Banumbirr site.⁶

When the multiplicity of names is reduced by identifying the actual locations, there appear to be seven places where Banumbirr is said to have stopped. These are, as they were described by one group of men;

Gundalmirri, which is a Naymil and Dätiwuy area .

Mayayikurr, named as a Djambarrpuyngu place.

Wäkurra, a Naymil place.

Djoni, a common name for a site on Elcho Is, said to belong to Murrunjun, Naymil and Golumala Clans.

Murrunga Island, which is a Murrunjun clan site.

Lunurr, belonging to Gamalanga people.

Marrwawurra, named as belonging to both Djinañ and Burarra people.

Thus with the movement of Banumbirr these sites (See Map 7.1.) are said to be linked together in a relationship based on the shared experience of having the ceremonial object visit them and with this the simultaneous experience with the spirit being of the same name. This then becomes re-inforcement for ownership interests in those sites by the clans related to the sites.

It should be noted that in Wadaymu's narrative and the separate discussions I had with him about the bark paintings which now follow, the word

⁶ By association with that, there is then implied authority over the iron ore deposit on which the town of Galiwin'ku is built, and following the logical progression from this there are then implied rights to an authoritative voice in the management of the town.

mokuy (spirit being/deceased person) is used consistently to describe the one who made Banumbirr. There is however a problem in translating this which I was not able to totally solve in the time available with him. That is, that it is not possible anywhere to say that this is definitely used to refer to a spirit being and not to an ancestral member of the clan who, having died, is therefore a deceased human. The two interpretations of *mokuy* are equally true. It is only Banumbirr which is explicitly termed *wajarr* (spirit being).

A bark painting of Banumbirr, by Wadaymu.

Every painting of Banumbirr by any artist serves to illustrate a particular emphasis or aspect of the Banumbirr complex. This first painting by Wadaymu (See Plate 7.1) together with the different interpretations he gives, again demonstrates clearly the ways in which meanings can be layered one on top of the other without them being revealed to the uninitiated. The layering of meanings in such paintings helps to introduce us to the analogous layering of meanings in the whole complex, but also helps to reinforce the validity of the paintings themselves as a vehicle of meaning and as an integral part of the complex.⁷

The painting is in the collection made by Groger-Wurm (1973:112 and Plate 163)⁸. Discussion with Wadaymu of a photograph of it and later of an enlarged drawing of it, led to the revelation of several layers of meanings in his painting. There was no conflict with the information he had told Groger-Wurm in 1973, sixteen years earlier, but over a series of conversations he shared more of the analogously layered meanings.

⁷ Again, in the interpretations of the pictorial representations of the Morning Star complex, the clan has its own particular focus associated with the relevance of certain aspects of the complex to Njaimil identity and to the importance of their part in the complex as a whole.

⁸ This painting was one of a collection of paintings which I, as art/craft supervisor at Yirrkala in 1967, sold to Wurm for the National collection. The photograph used in discussion was one that I had taken at that time. The photo in the plate is by courtesy of Margie West of the N.T. Museum, where the painting is a part of their collection.

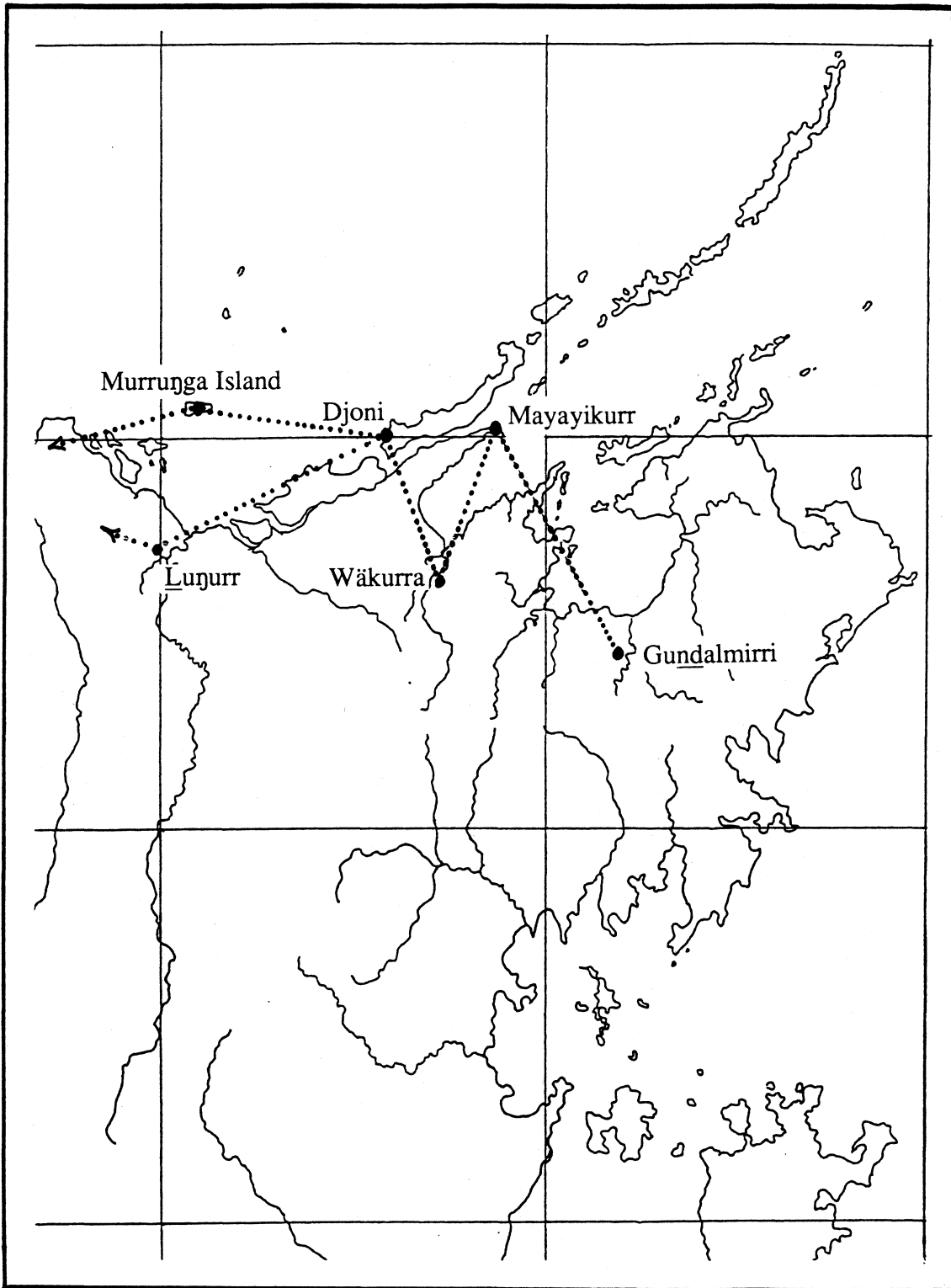

Map 7.1. N̄aymil version of the journey of Banumbirr.

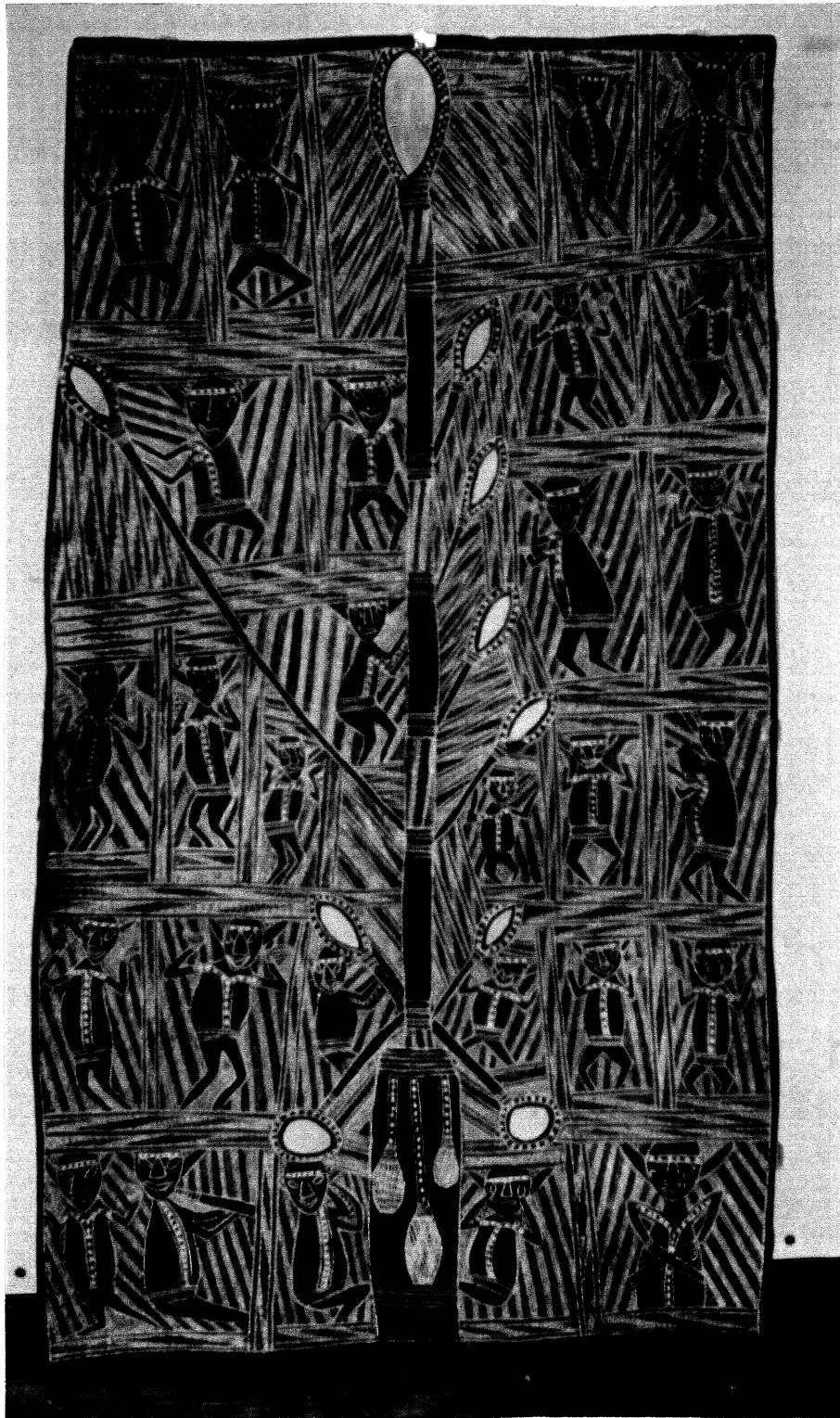

Plate 7.1. Wadaymu's painting of Banumbirr.
(Art Gallery of the Northern Territory).

Groger-Wurm recorded this picture as an illustration of the Njaimil Morning Star at Gundalmiri [Gundalmirri] with the star (Figure 7.1, No 1) represented as being on the end of a pole. Wadaymu told her that the pole of the star is decorated with alternate sections of painted areas (Nos 2 and 3), feathered down, and human hair string binding. There are two women shown, Malumbu [Mälumbu] (at 17) and Jambujambu (at 19). The "dillybag" in which the Morning Star is kept is shown at the bottom of the picture (No 16) . In the picture there are, superimposed on the dillybag, three pendants (Nos 13, 14 and 15) attached to the base of the pole. These were described as yams, the food of the mokuy. Dots on the strings were said to be the feather down entwined in it.

In my own first discussion with Wadaymu, what he told me demonstrated that the version of the story he had recorded earlier had identified the visual elements of the picture in terms of their more openly obvious meanings. The painting was ostensibly a representation of the Morning Star dancing pole. In the diagram the numbered elements of the pole, 2 and 3 are painted sections of the wooden pole separated by banded sections which represent sections of string and feathers. Elements numbered 4 to 15, represent strings attached to the pole, each of which is tipped with a tassel of feathers. Panel No 17 is of the woman, Mälumbu, wife (?) of Goṅ-bilma, crying. He made no comment to me about the second female figure⁹. Panel No 18 represents Goṅ-bilma, the name used for the mokuy that made the pole, in his role of continuously singing and playing the clapsticks. The dancing figures in the other panels are all mokuy and of these the four across the top of the painting (Nos 20 to 24) are the leaders for the ceremonial. There was then no significant difference between this set of details and the ones he had described to Groger-Wurm.

⁹ In this investigation I tried to be open to what he thought of as significant to tell me and so did not ask for details that were not forthcoming.

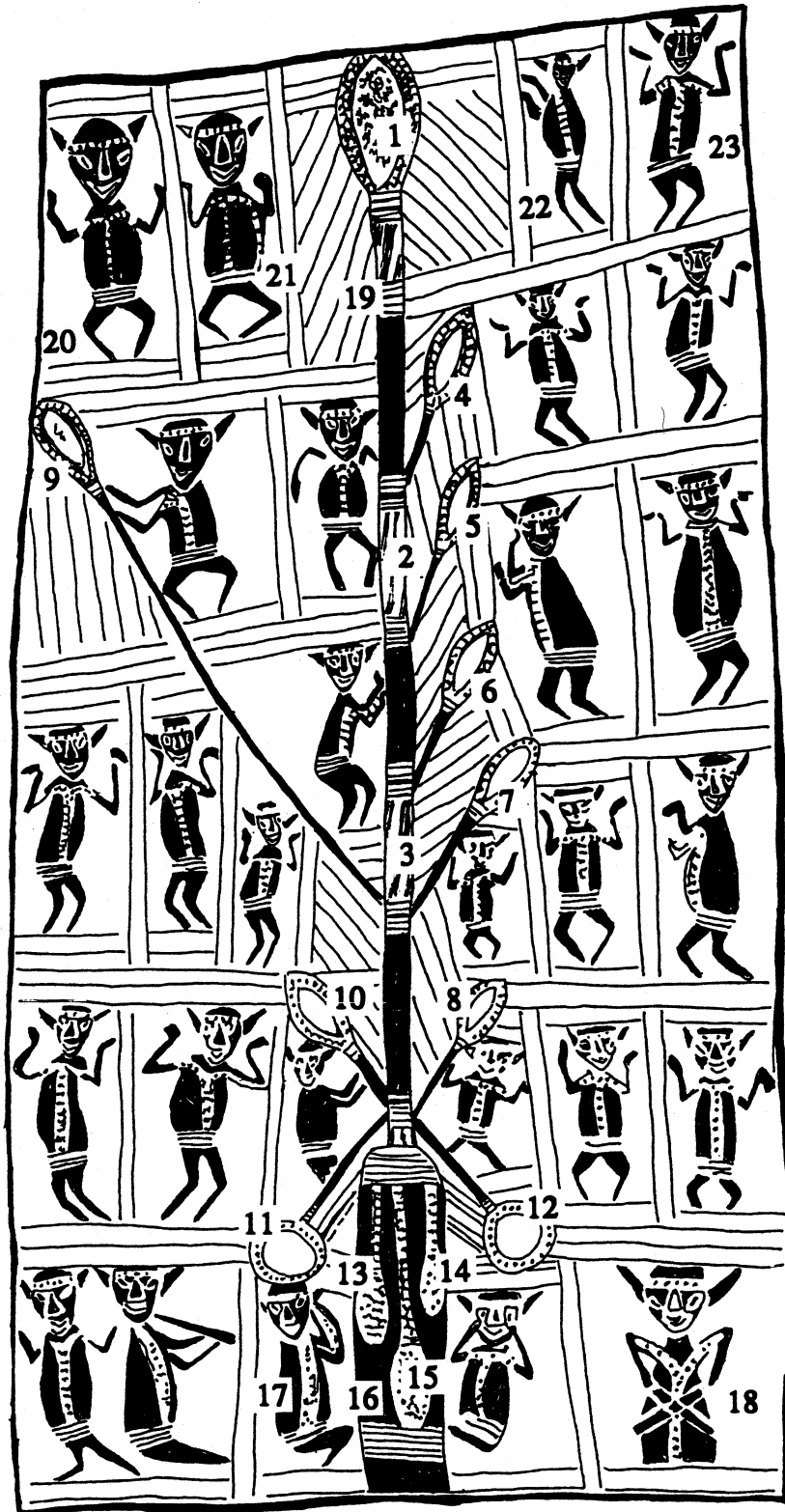

Figure 7.1. Details in Wadaymu's painting of Banumbirr.

In addition to the above meanings for the visual elements, various elements of the Morning Star pole also represent particular sites that are linked through the travels of Banumbirr. Those sites represented by the pole and feathered tassels in this painting were identified during a later discussion with Wadaymu as follows:

- | | | |
|-------------------|-------------------------|-----------------------|
| No 1. Marrawurpa. | No 2. Murrunga. | No 3. Galiwinku. |
| No.4. Djomaņa. | No 5. Gawurruņa. | No 6. Yalatawuy. |
| No 7. Dhamurruņa. | No 8. Birrkpirrkpuy | No 9. Njanggalala. |
| No 10. Gurukpuy. | No 11. Djirritjirriwuy. | No 12. Malkurruņa. |
| No 13. Njathuņa. | No 14. Lombaņa. | No 15. Gudumurrkuwuy. |
- No 16. The larger base of the pole, within which are drawn the sites numbered 13 - 15, represents the larger site called Gundalmirri.

When the place names listed by Wadaymu were checked with two other men they identified these names as follows;

Djomaņa, Gawurruņa, Yalatawuy, and Dhumurruņa are all Naymil places at Rorru, a homeland centre being established jointly by Dätiwuy and Naymil clans. Lombaņa, Gudumurrkuwuy, Njathuņuwuy, Djirritjirriwuy and Guruwukpuy are also Naymil places at Rorru.

Birrkpirrkpuy is the name of two places, a Gunbirri Murrungun site at Dalmana Island which is part of Galiwin'ku and also a Naymil site at Rorru. *Birrkpirrk* is the name of a bird which announces the new arrivals at Burralku.¹⁰

Marrawurpa is a Liya-gawumirr place close to Gärriyak.¹¹

Malkurruņa was not known.

Murrunga Island is a Murrungun Mälarra site close to Milingimbi.

This means that the list of names given by Wadaymu for the sites were not an exhaustive list of the different territories linked to Banumbirr, but focussed mostly on Naymil sites and added one or two others that were linked reasonably closely.

A third complete set of meanings made available on a different occasion focusses on the pole with its attached tassels as being a representation of the yam

¹⁰ (also Groger-Wurm p110). When the suffix *-puy* (pertaining to, concerning, associated with) is added to the bird's name it forms a name for the location which then means "Associated with Birrkpirrk".

¹¹ Wadaymu in discussing the narrative version of the myth identified this as a place belonging to the Burarra people and it can easily be the name of two distinct places.

plant, *duyga* (*Ipeomea graminea*). The central pole is the main stem of the plant. The feathered tassels No 4 to No 12 are flowering branches of the vine, the three pendants Nos 13, 14 and 15, are its roots, the yams, which are growing down into the earth (represented here by the "basket").

There are then at a minimum, three completely different sets of meanings available from this painting, each being contained in a different set of visual analogical references.¹² One other transformation which Wadaymu had described to me earlier, and which is of major significance to the Njaimil and some of the other clans. That is the transformation to Warrukay (the barracouta).

The Story of the Fish, Warrukay. Multiple Meanings.

When I first began to manage the art/craft business at Yirrkala in 1967 it was the practice to write up the story of each bark and to glue it on the back of the painting as this increased sales. One of the painters from the Njaimil Clan brought in a small painting of the fish Warrukay. The story I was told to accompany the picture was something like this.

This is the fish Warrukay. It is the Barracouta. This fish swims from the salt water to the fresh water and back again. The lines of spots are the bubbles that come to the surface as it swims and cleans its teeth.

Some twelve months later Wadaymu brought in a second painting of the same fish. Having learned that many of the paintings that looked like representations of natural species were pictures of ritual objects I asked him, "When you make this what does it look like?" His reply then was in terms of the use of Warrukay as a ritual object.

We make it out of a hollow tree like that, (indicating a pole about 20 feet high), and we carve those two long points with the teeth. They are the jaws of the fish. It is a wooden *ranga* (sacred object). We dance with it before we stand

¹² These however are only the meanings explained during brief discussions with Wadaymu and do not in any way exhaust the potential of the painting, nor do they give more than a hint of the broad spectrum of transformations of Banumbirr.

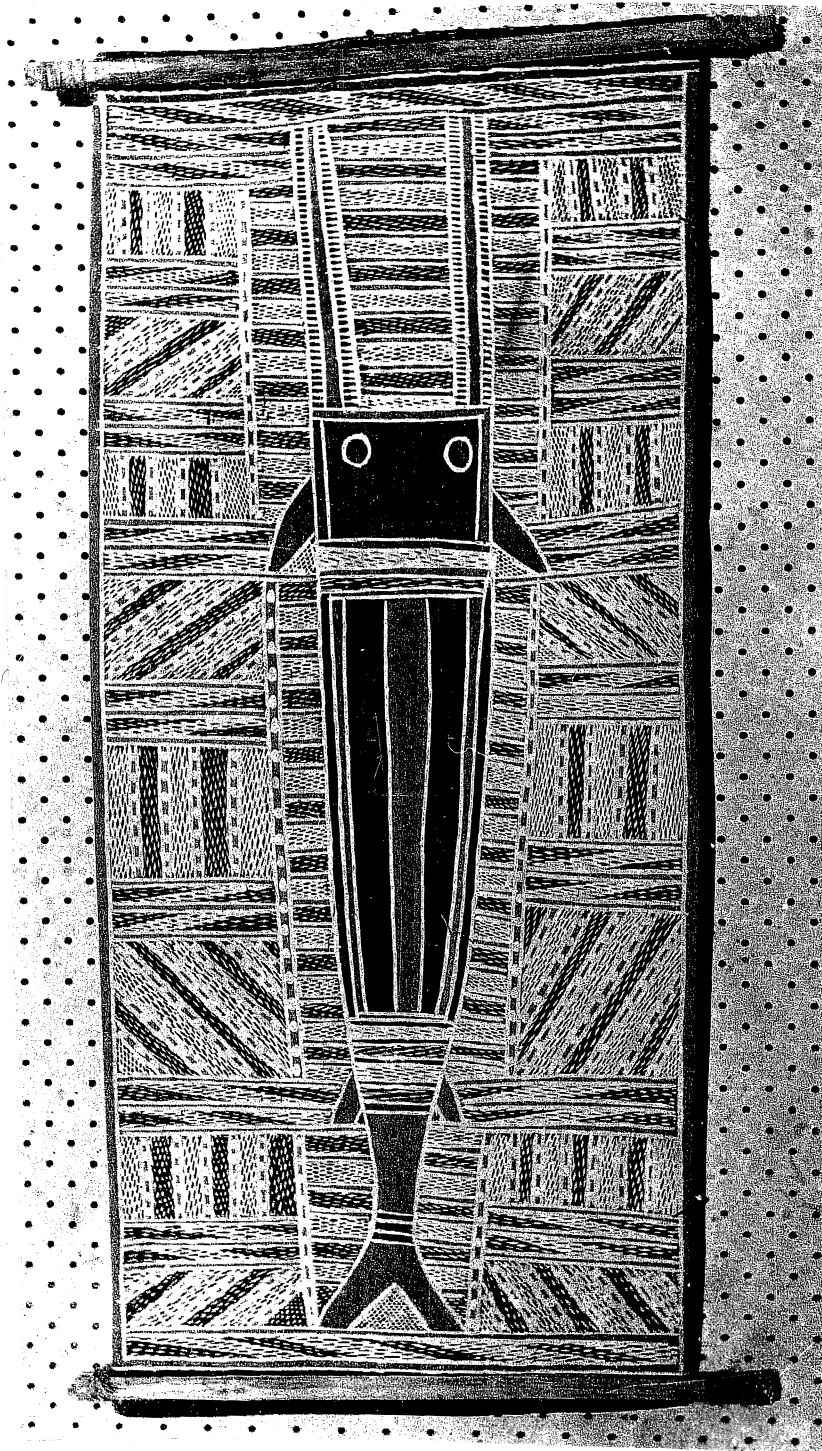

Plate 7.2. Wadaymu's painting of Warrukay.

it up and we dance it from the salt water people to the fresh water people and back again, and we put the painted bones of the dead person into the hollow after they have been carried round for two years in a small container.

These two stories are quite different yet there are analogous relations between parts of them. What was, in the first version, fish swimming, is fish sculpture being danced in the second. Movement from salt water to fresh water in the first, is movement between salt water and fresh water people. That is those who have their sacred country on the sea coast, and those who have their sacred country further inland in fresh water

Years later, in discussing a photograph of a similar painting of his with Wadajmu (Plate 7.2.) he shared the following details, using an alternative name Murukula for the figure in the painting. This time his focus was on the symbolic interpretations of features of the painting rather than on the actions of the fish or its use in ceremony. In this version I discovered for the first time that the barracouta was a transformation of the Morning Star. The fish's body is a transformation of the pole of the star as described in the first narrative and illustrated in the painting collected by Groger-Wurm.

Murukula¹³, the ancestral being of the Njaimil, he brought *ratjpa* (haematite red ochre) to Elcho and Dalmana from Gundalmirri and then he changed and became Murrūnūn. That red painted part on the head is that place Gundalmirri. The long yellow stripe along the body is *gupumbu* (the backbone), the black stripes are the skin, and the red and yellow lines across the body at the arms (fins) are where we join on the Banumbirr (Morning Star) string, three strings on each side, and the long spotted lines on both sides are the morning star string.

These three interpretations of the Warrukay pictures form yet another perfect example of the ways in which information concerning any similar sectional network within the Yolŋu Cosmos can be restricted or expanded according to contextual requirements. Whether the first man told me the simplified story because I was just beginning to learn from the men about their stories or whether he was not

¹³One of the important names for the barracouta with particular reference to the barracouta object.

senior enough to relate the more important version is an unanswerable question. There could be a number of reasons. The point is that there are potentially many versions. One at least of these is elementary and gives no clue as to the depths of meaning that really exist, and no indication of the amount of symbolism that is included for those who can interpret. The second describes the practical use very briefly, and the third introduces symbolism. In addition to the above I was, at a different time, told by another Njaimil man that Warrukay was left at the Gundalmirri site by the Djaŋ'kawu, and that in paintings it is shown hiding under the water weed called *darra*. In Plate 7.2 this is represented by the diagonal (yellow) lines of the background pattern.

To this point I have introduced the Morning Star as seen by one clan, and mostly as through the eyes of one man. There have been shown three different transformations of the star; its ceremonial form, the yam, and the barracouta. Each transformation is both a discrete identity in its own right, and simultaneously each is an expression of the single focus of identity which in this case is named Banumbirr. In the sections which follow I will first discuss extensions to this complex as they relate to other clans of the Gapiny group and then examine some of the ways the complex extends to the edges of Yolŋu territory and beyond.

THE GAPINY GROUP'S PERSPECTIVE.

The Gapiny group is composed of three clans; Dätiwuy, Golumala and Njaimil, who are established as a group on the basis of shared, though different rights in sites and sacred objects which focus on Banumbirr in different ways. The three clans have gained very different degrees of power and prestige in the Galiwin'ku community and this appears to have been related to choices that were made in the past by the senior men. Of the three clans, Dätiwuy, led by Muwarra, have continued to be a very traditionally oriented group, with the men spending most of their time living on their homeland centre at Rorru, although Muwarra has married daughters living at both Yirrkala and Galiwin'ku. The Njaimil at Galiwin'ku, Wadaymu's family,

normally joined in any major Christian events, but at the same time Wadaymu acted as one of the ritual leaders in most traditional ceremonies in the town¹⁴. The Golumala clan, are mostly the descendents of Wili Walalipa¹⁵, one of the two leaders who came from Milingimbi with Harold Shepherdson with the express purpose of founding the then, new mission, which is now Galiwin'ku township. Wili, like Muwarra and Wadaymu was a ritual leader, but unlike them he ensured that his children got the best Western education they could. His sons have maintained their ritual status and involvement, although perhaps not with their father's seniority. In contrast they have taken a leading role in the Christian church and in the community. One of Wili's sons is an ordained minister in the Uniting Church, was the minister who led the church at Galiwin'ku during the Revival, and has subsequently been both Moderator of the Northern Synod of the Uniting Church, and Chairman of the Aboriginal and Islander Congress of the U.C.A. and is now a member of the central committee of the World Council of Churches. One of Wili's other sons is a preacher and elder in the local parish and one of the grandsons has begun training for ordination. One daughter is an elder in the church and simultaneously the Principal at Shepherdson College, the school at Galiwin'ku.

As a public indication of the Golumala clan's commitment to Christ there was in the church building a painting of the cross of Christ with a barracouta on either side of the cross (See Plate 7.3). The notes I made of the comments made by one Golumala man concerning it read as follows,

That painting in the church with the two warrukay and gapu. Two *guya* (fish) represent *yätjkuru yolŋu*. (lit. bad people =two thieves on each side of the cross). Use them because they are our totem. White colour on side represent white *gapu* (waves) (*Dhuwa gapu*) Red rocks in corners represent the red *gunda* (rock) here. The round ones in hole where *warrukay* (barracouta) live and swim through. Might be just rock or animal or story now (without meaning). Who know.

¹⁴ Wadaymu and his wife and two eldest children moved to Maningrida in the middle of my 1989 field work before we could carry the above discussions any further and I had no later contact with him.

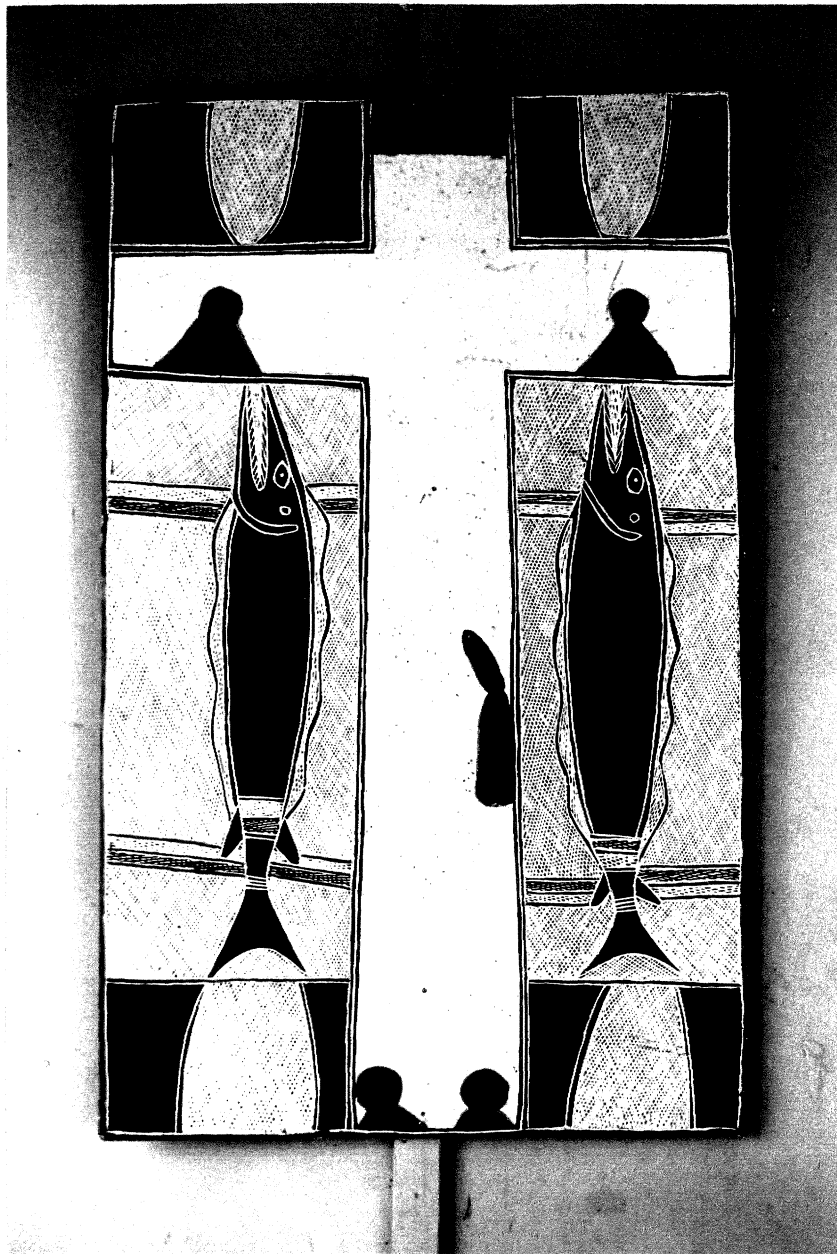

Plate 7.3. Cross of Christ with thieves represented by Warrukay.

When we giving something to the church why sacrifice and giving totems to church instead of changing heart and being living sacrifice. Yesterday's story,

[Daṇataṇa preached on the previous day] it's the person that has to change, not the things we make with our hands. He's talking about the person. That's thinking story but deeper meaning is more to deal.

On a different occasion he referred to the nature of his clan as barracouta, emphasising the negative aspects of the fish and hence the clan members, as it was prior to their meeting with Jesus. They were "just like those criminals". The second paragraph above was made to emphasise an interpretation which referred to the painting as representing giving not just the totem (Warrukay) but themselves (as Warrukay) to God and that without the latter, the giving of the totem was of no value.

Thus in the Gapiny conglomerate, while all have maintained their focus on traditional religious practices and lifestyle to some extent, between them these three clans have taken as wide a spread of approaches to change as could be expected to be found anywhere in North East Arnhem Land. One clan is very strongly traditional in their religion and life style, living mostly at their homeland centre, one is strongly oriented to things Christian and Western¹⁶ and one is ambivalent, attempting to follow both directions simultaneously and gain advantages from both. The relationships between the three clans and between them and others were described for me in various ways using Banumbirr transforms as analogues of the relationships and it is these on which I now focus. Some of these were discussed in Chapter 4 where I quoted Daṇataṇa's use of the yam as a model of relationships and of the growth of the clan.

Over a period of time all three of the Gapiny clans have attempted in different ways to establish their rights in the Galiwin'ku town area on the basis of the Morning Star complex and its various elements.

¹⁶ Of the three, I had very little contact with the Dāṭiwuy clan, largely because they spent most their time at their homeland during my time at Elcho.

Banumbirr and Title Claims.

When the second hospital was built at Galiwin'ku, the original building became the craft room. At the time when I first took over the management of the men's craft I noticed that there was an old weathered carving of a fish (later identified as a barracouta) nailed over the door. At that time I mistakenly assumed it was advertising the building as a craft centre. Years later (1981) when I first saw the present (third) hospital, I noticed there was a painting of the same fish nailed over the main entrance. (See Plates 7.4 and 7.5). In 1989, that painting was gone. I mentioned this to one of the Golumala men, who was at the time running a fishing business. He explained that it was a barracouta that his father had painted, and that after his father died, he brought it home and nailed it up in the fish room. It was to him like having something of his father's identity there.

He allowed me to photograph the painting in its new location and explained something that I had not paid attention to before. While the centre of the painting is a naturalistic representation of the fish, along the edges of the painting were two long thin transformations of the fish that represented the Barracouta as the pole of the Morning Star. Along the sides of these were sections marked off with painted stripes representing sections of the poles decorated with feathers and string, and between these striped sections were painted the bones of the fish. These bones were called *muyugu* (also the name of a renowned poisonous plant) and signified one side of the clan's personality, its extremely poisonous (dangerous/ferocious) nature when involved in warfare.¹⁷

Concerning these uses of first the sculpture and then of the painting on the hospitals, one of the other brothers observed that this was an explicit statement being made by the Golumala clan of the significance of Warrukay in the area and of their

¹⁷ See later quote concerning birth and death.



Plate 7.4. Painting of Warrukay nailed over the hospital entrance.

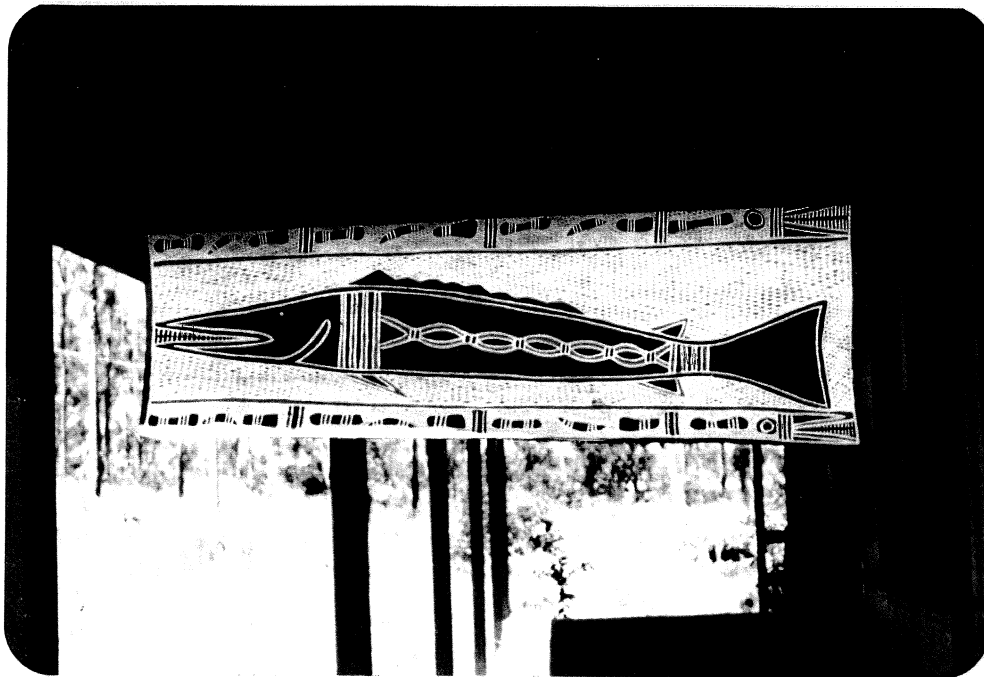

Plate 7.5. Warrukay painting showing Banumbirr poles along the sides.

identification with and authority over the activities being undertaken in the hospitals. In the newest hospital this is emphasised by the fact that the hospital is built on an actual Warrukay site.

As described earlier in Chapter 5 (B4) one man told me how Wili Walalipa had been sent with Harold Shepherdson to set up the mission at Elcho. He had been sent by an old Gunbirrtji man on behalf of the Gunbirri¹⁸ and Mälarra clans to care for their *madayin* (sacred elements) at Elcho. This was based on the shared ownership of Warrukay.

A different man told me of how Wili had arrived on the Island with Harold Shepherdson, anchoring the boat on the Eastern coast, and of how they had walked across the island and then down the western coast until they had reached Dhudupu (First Creek), where they had met two old Gunbirrtji women and had made the arrangements with them there about establishing the mission. When I was with this man at Dhudupu he asked me if I knew about Warrukay there. When I invited him to tell me, he told me of Warrukay's (Wili's) arrival at Elcho as if it was a story of the arrival of a fish.

Warrukay (barracouta) came from a long way away, Gurka / Nada'yun [Wili's Homeland Centre]. *Warrukay* came up the creek. See how it's wide up there in the creek and out there, but narrow at the mouth. At first it wasn't narrow. It (*warrukay*) went in, but when he was coming back it cut him off and he's up there now. That's the special place. They got rights if there's any meeting or any arguing or anything. My two *märi* (Mother's mothers [from Gunbirrtji clan]) and Wili feeling each other through that. Never mind that Bäpa Sheppie brought the good news. Never mind but that old story was there.

Q. So the authority for Wili to come here was through Warrukay from Gunbirrtji?

A. *Bilin*. (You've got it). He was *djäkamirr* (one who cares for) and *Wadaymu djäkamirr* and even Garrawurra *djäkamirr*. They've got *Gunbur* (rights to the sacred terms).

Whether the sandbar across the mouth of the creek was relatively recent or not I didn't discover, however it was an analogical description of Wili's arrival and

¹⁸ Gunbirri and Gunbirrtji appear to be different names for the same clan and used interchangeably.

permanent settlement at Galiwin'ku. The "myth", apparently only one generation old, speaks of Wili (as fish) coming from his homeland centre (which is a Warrukay site), seen as his real place of origin, although he actually grew up on Milingimbi, and as a man came from there. The comment on "feeling each other" refers to the discussion based on mutual rights in Warrukay shared by the two clans and the feeling out of Wili's credentials. Also implied in the story is the idea that Wili as Barracouta, brought with him his version of the sacred object and that it, together with the spirit being it represents, is now established permanently at Elcho, thus giving Golumala unchallengeable rights there. The reference to "that old story was there" poses some difficulty. It may refer to the creek already being a Warrukay site, in which case the story as it was told to me has the possibility of being an adaptation of an older myth. Nevertheless, as it was told to me the reference to Wili was explicit and that is the point I wish to emphasise here.

On one occasion Danjataṅa used the Warrukay transformation and the relation between two different adjacent sites in the Galiwin'ku township to talk about the generation of his own clan at Elcho.

Gondarra dance barracouta, representing the Morning Star *ṅaraka*. (core)
The burial place for my father (Wili Walalipa) is Nalkanbuy, which is the place where the fish lays her eggs. Gukuda reef is where the fish lives. The current tank site had a sacred tree with the nest for Damala, which watched the fish as it comes in to lay eggs (*Djekurr*) at the burial place.

There are two sites involved, each representing a different Dhuwa clan, Nalkanbuy, the present hospital site, where the barracouta is said to have laid its eggs, and next to it, Damala Yalu (the Sea Eagle's Nest)¹⁹ where the town's high level water tanks are now built. Interpreted, this then says that the Golumala fish (which in this context refers to Danjataṅa's father)²⁰ came ashore and laid eggs (established his own family line). The eagle (other Dhuwa clan) watched this and approved.

¹⁹ Damala, the White-breasted Sea Eagle is listed by Clunies Ross (1988.37) as Damalkurra, and as one of the Morning Star spirit beings.

²⁰ Danjataṅa's father and several related kin are buried in a family graveyard now established on the site (see Chapter 5 for further discussion also plate 5.5 and Map 5.7).

This apparently simple story of the eagle at its nest watching the fish coming to its own adjacent nest²¹ is one example of a Yolŋu way of referring to the establishment or maintenance of a relationship between clans. It brings us to another aspect of Gapiny group perspectives of the Banumbirr complex; that of the relationships between clans that are either established through it or affirmed through it.

Relations between clans.

Djiniyini Gondarra asserted that Golumala had a central role to play in linking other clans because they are connected to the *naraka* (the central wooden core) of the Morning Star and other clans are the *wana* (lit. arms = tasseled strings) of the Morning Star. He said that,

There are several different strings which run out. They represent different clan groups, Djapu, Murrunun, Naymil, Djambarrpuyŋu Dhamarranydji and Djambarrpuyŋu Guyula and many others. Golumala and Naymil represent the *naraka* (bone/core).

We are called Gondarra Yarrayarmirri because we identify with the *raki* and *naraka* (the strings wrapped around the core) of the Morning Star. The surname Gondarra comes from that *naraka* (core), and tells story about Warrukay. There are the names for that *naraka*, Guyulun, Marawirru, Djunmildjunmil, Gupumbu, Gondarra, Guyuwu. It has those names because it represents fish. That (identification with the strings of the core) gives us a central role in linking the other clans together, as they all connect to the central strings (and so without us the connection would not be there for them). I don't worship it, but respect it because I gain something from it. Others respect it also.

On a separate occasion he said,

There are three names for the *naraka* (the wooden core or stem) of Banumbirr. Gondarra, Guyuwu, and Yarrayarmirri. These three are used for *gunbur* (evocations in the form of sacred names)²², so that we *gunbur'yun* (call out evocations) like this, "Gunbur Gondarra, GunburGuyuwu, Gunbur Yarrayarmirri. For Golumala, the *naraka* (core) comes from Gundalmirri which is close to Buckingham Bay. In the dreamtime at the start of its journey it also took special stone (*ratjpa*). Muthamirri Gunuwaŋa were the original people here, and then Guyuwu Gondarra, Yanmaŋa Dar'miny, and Naymil Yalwutjŋu. Milinditj is another name for *ratjpa* (haematite ore). It also has two other names that you can't publish that are used for *gunbur*'.

²¹ "Nest" has also analogical references to grave, sacred site and homeland centre and see also Morphy (1984) who describes a funeral as a journey to the crocodile's nest.

²² Both moieties practice this calling out of sacred names for a variety of ritual purposes. Dhuwa clans precede each evocation with the word *gunbur*' Yirritja clans use the word *dalkarra*.

Here the centrality of the strings on the core of the Banumbirr pole (as also described earlier by Wadaymu in relation to his painting) are used as an argument that runs as follows.

The strings, with feathered tassels attached, which represent the other clans involved, are attached to the strings that bind the core of the pole, which represents the Gapiny group. [Though in this case, primarily Golumala and secondarily Naymil]. The core strings support the other strings and form the foundation for them all, therefore it is the clans represented by the strings on the central core which have the most significant role in establishing relations between the other clans.

Djiniyini on an earlier occasion had suggested to me that this same position on the core was one of the reasons why Golumala clan had such an important role to play in the Christian church, because they played a central role in the relationships between the clans. As well as carrying messages about Gapiny group relationships, the complex carries cosmological analogues of the Yolju understandings about birth and death.

Concerning Birth and Death.

Inside the mouth of the Barracouta is what was described to me several times as "a basket" (*bathi* or *batji* according to dialect) that was very important. Three separate statements were made to me by different members of the clan.

There are three names for the *bathi* where all the little fish go in. They are Dhawuthawu, Gayirrama and Yalakanydja. In the centre of the picture is a single large painting of the actual fish, *warrukay*. Along the two sides of the painting are two long thin *warrukay* representing the Banumbirr with feathers.²³ *Muyugu*, the bones of the fish are painted scattered along these. When the large *warrukay* is used for burying *yolju naraka* (people's bones) it is called Larrayaya by Malarra and Marawirru by Golumala and Naymil.

The *bathi* inside *warrukay*, what do you call it? Guts? sorts good food from bad and vomits out the bad. That *bathi* is called *dhawuthawu*.

There are two different sorts of *nanmarra* (conical mat). The names Murrugu and Dhawuthawu come from the Warrukay gill covers. Call it *batji* (basket) not *nanmarra* (conical mat). The barracouta has small strings on the outside of its gills that hang from its throat. There is a *bathi* (basket) in its throat. Real ownership is Golumala Gondarra and Yalwutjiyu Naymil.

²³ This was in reference to the painting from the hospital (Plate 7.4).

This basket appears to be able to be perceived in different ways. One as the guts or belly of the fish or the hollow space inside it and one as the removed head of the fish which with its gill covers is slightly basket shaped. It appears though that in general it is thought of as the hollow area inside the fish. An interesting juxtaposition in the third statement links together the conical mat (*ḡanmarra*) and the ceremonial basket in much the same way as they are linked in the Djaḡkawu story.

The large Barracouta described earlier by Wadajmu in his bark painting, is used as a coffin. Another man explicitly linked this use as coffin with the idea of it being also a canoe (or boat) and a basket, when we were discussing different names for coffins.

Larratjitja is the boat name for Rewa [a leading Gunbirrtji man]. It is *maḡayin* (sacred object) of Gunbirrtji and is both Larratjitja and Warrukay.

The outside term is *warrukay* for all Dhuwa, for three tribes, instead of saying "coffin". You can say "bathi" for everyone. Like, "Bathi (coffin) is coming tomorrow", or whenever. But the special name Larratjitja is for any Gunbirrtji person's coffin.

The coffin is a picture (image/representation/transformation) of the Yirralka (homeland centre).

Naku (canoe) is a term used for all coffins, but *marthayay* (boat) is for Yirritja only."

In this set of comments we find Warrukay linked to the place where the little fish swim in, (a euphemism for spirit children entering the mother's womb) to a basket (with similar meanings) and to the canoe (which is simultaneously a basket) which transports the deceased to their homeland, while also being a transformation of that homeland. Each of these is then, according to context able to function as an analogue of the other with the implication that the little fish can also refer to the deceased returning to their homeland.

The choices made by each of the three leaders of the three Gapiny clans are reflected in the kinds of power held by their children within the Galiwin'ku community. Nevertheless the choices made by them and their children, and the advantages gained are all supported on the basis of mythology. The Morning Star

complex is used by all of them in a wide variety of ways to justify such things as personal or clan status, power and relationships of all kinds including dominance or interdependence. It is also used to verify identity. In such uses of the complex there is also opportunity for expressing indirectly or directly a range of attitudes from antagonism to disdain.

Each of the clans gains some advantages from the corporate nature of the group, particularly from the increase in support that this brings when in confrontation with outsiders. However each is also in competition with the other for shared assets, and each therefore very carefully emphasises its own priorities and its own significance, using the Banumbirr complex to its advantage in this, not only within the group but also in relationship to other clans to which they are connected.

OUTWARD CONNECTIONS THROUGH BANUMBIRR.

To this point of the discussion, the connections made between clans through Banumbirr and its transformations, have been considered from the perspectives of various individuals from the Gapiny group of clans. I now examine some of the outward connections which facilitate relationships with others of the Yolŋu clans and beyond these to peoples outside the Yolŋu cultural and linguistic block. I examine first some comments made by people from the Gälpu and Djambarrpuyŋu clans at Elcho, and by members of the Djapu and Rirratjiŋu clans at Yirrkala. Following this I give indications of ways of tracing the complex outward. The section then finishes with some evidence of the further spread of the complex both within and beyond the Yolŋu block.

Gälpu Perspectives.

There are two groups known as Gälpu, who are distinguished from each other on the basis that one group has its sacred objects linked to the sea or saltwater and beaches, while the other group links its sacred items to the freshwater and inland

locations. According to a Gälpu *Monukpuy* (saltwater side) version of the story Banumbirr was first made by Wuluwuma at Nandjijura. A Gälpu *Raypinybuy* (freshwater side) man said however that,

Banumbirr starts at Burralku and comes from there to Buku-dal (a Gälpu and Djapu site). From Buku-dal it travels in two directions.

It travels south to Garrawanbuy Island (Dhudi Djapu) and then to Windapi (Murrugun) where there is a pandanus tree where he landed. From there it travels further south towards Numbulwara.

It travels northwest to Gundalmirr (Naymil), then west to Wakurra (Liya-dhalinymirr Djambarrpuyru) which is between Lake Evella and the barge landing. From there it continues to Dhudupu on Elcho and from there it continues west.

This version from the second Gälpu group overlaps in its details with some of the locations given in Wadaymu's story, but claims that the start for Banumbirr's journey is from a site held jointly by both Djapu and Gälpu clans (See Map 7.2). All the Gälpu paintings of the story that I have seen have been done by a *monukpuy* (saltwater clan) artist and have focussed on the yam transform of Banumbirr and on the story of Wuluwuma the *mokuy* (dead one/spirit being) belonging to Gälpu. This being is portrayed as constantly hunting for yams and is said to have dug out male yams first and then female ones.²⁴

Three paintings by Mandjuwi were available to me for discussion with Gälpu men. One of them (Plate 7.6) a half-finished one at the time of photographing, has been included because of the way in which it portrays Banumbirr as yam and some of the spirit beings dancing around it in the transformation as butterflies. It is also simultaneously a painting of the spirit beings dancing around the Morning Star and even though not finished the basket in which the Morning Star is kept can be seen in the lowest fork of the "strings".

The second painting (Plate 7.7) shows, at the bottom of the picture, two transformations of the spirit being who made Banumbirr. Wuluwuma is shown on the left and Yajurruyarr on the right. Above them two *gukuk* [doves] are directing them

²⁴ In Gälpu ritual these are constructed differently, the male one with three strings and the female with one.

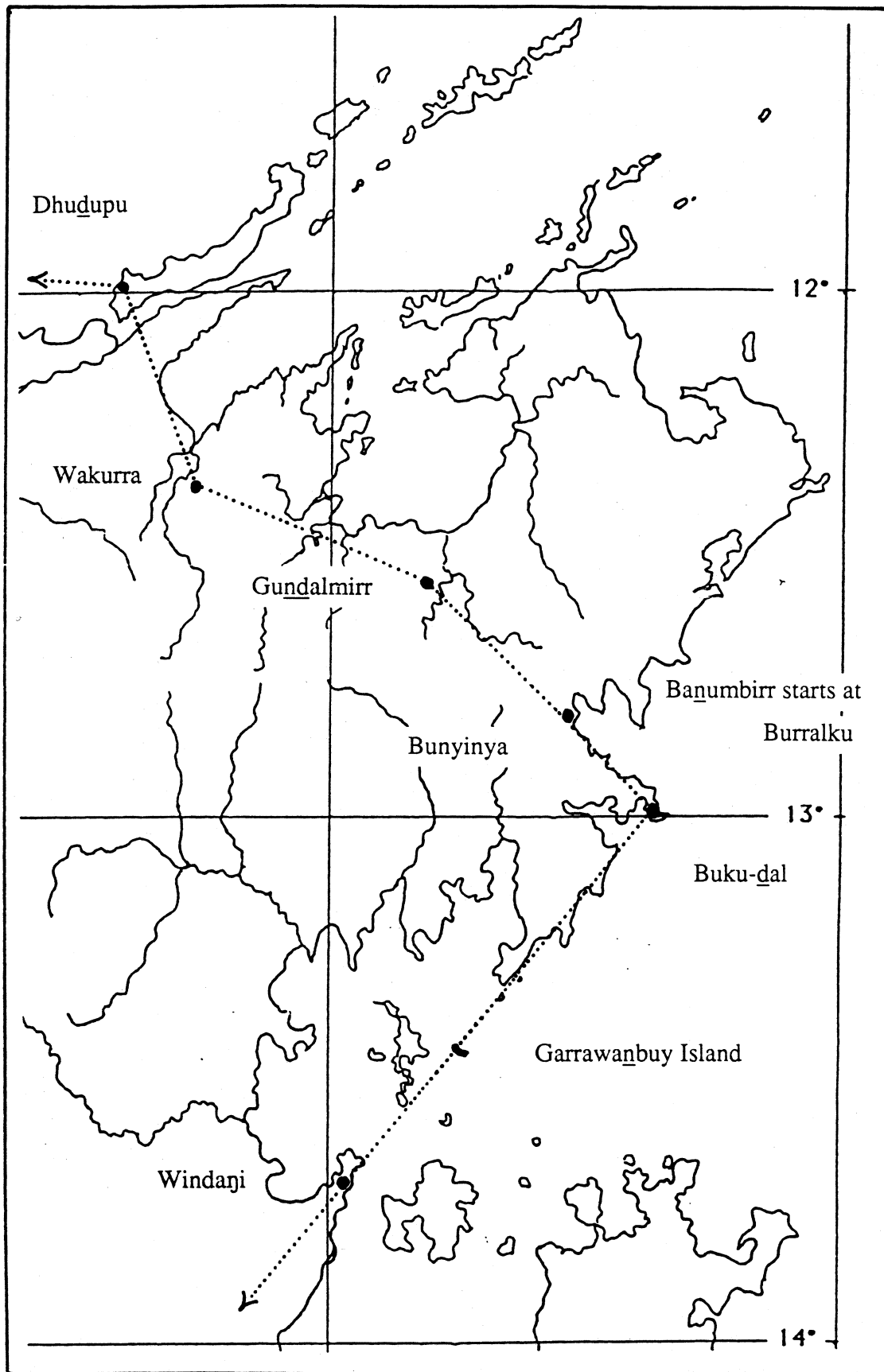

Map 7.2. Gälpu Version of the journeys of Banumbirr.



Plate 7.6. Mandjuwi's painting of Banumbirr as yam.

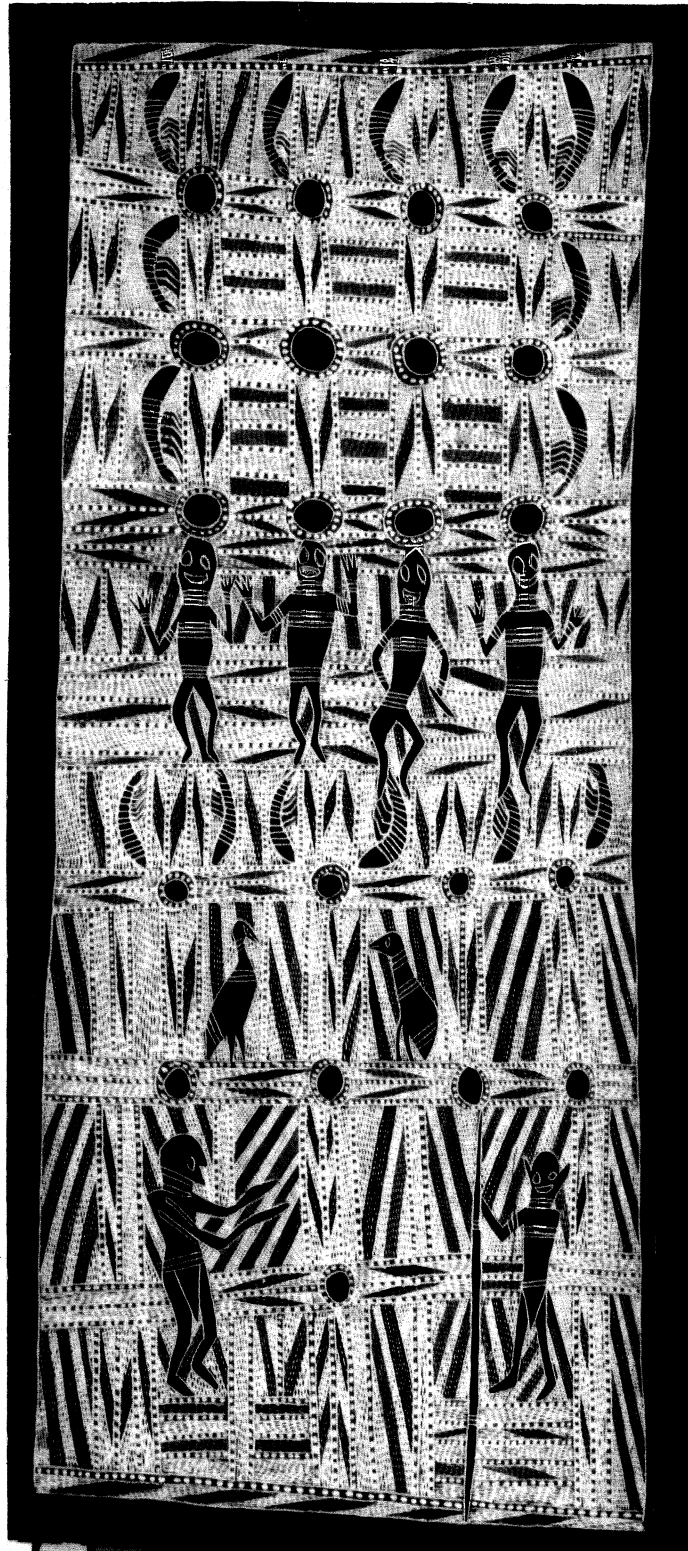
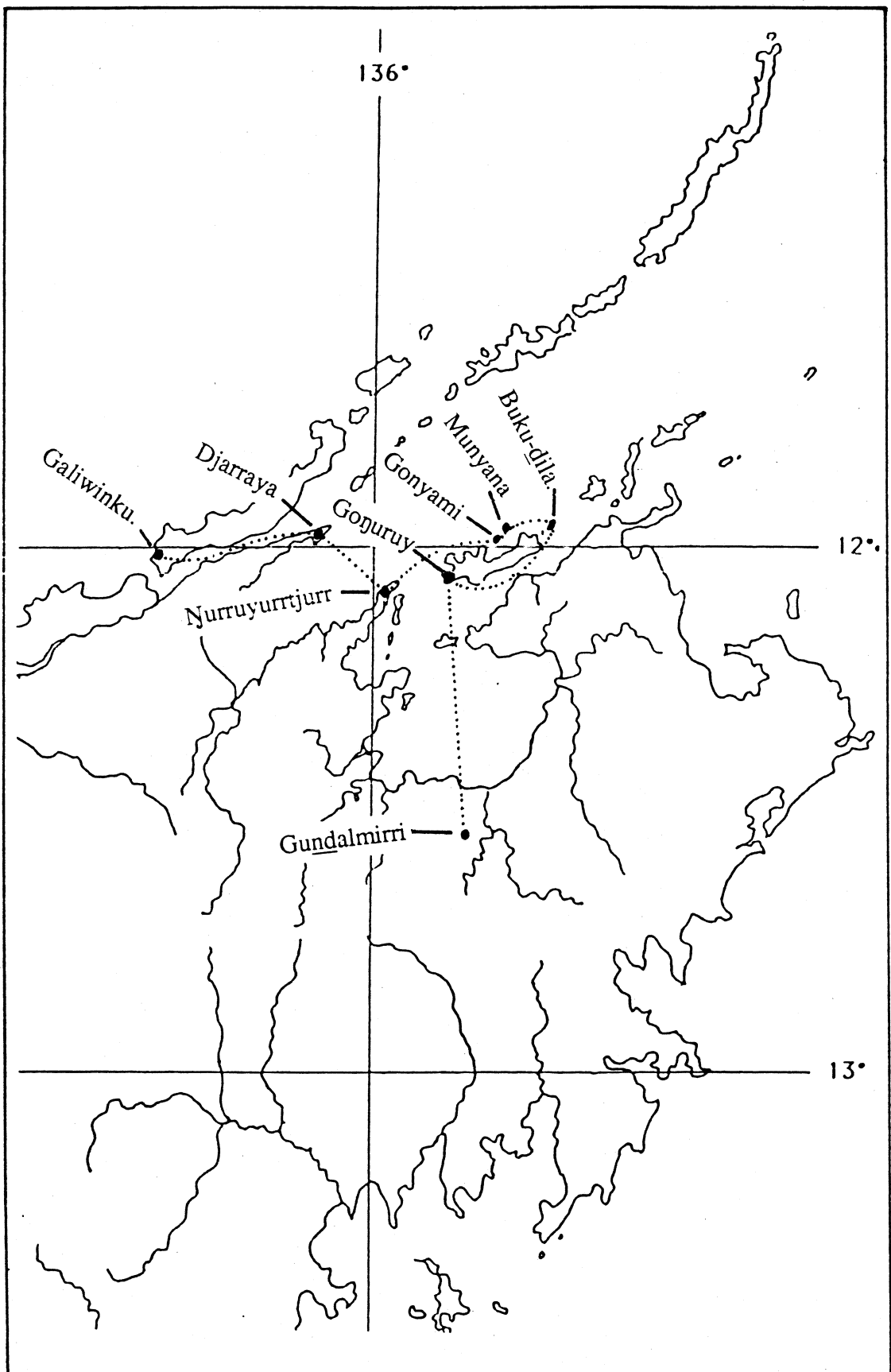

Plate 7.7. Gälpu spirit beings who made Banumbirr. Painting by Mandjuwi.

(Australian National Gallery, Canberra).



Plate 7.8. Gälpu spirit beings gathering the yam *gulaka/ganguri*..
Painting by Mandjuwi. (Australian National Gallery, Canberra).



Map 7.3. Djambarrpuyngu version of the journey of Banumbirr.

where to find yams and above these are four of what were described as "old people". *Wurrkadi* [an unidentified grub or perhaps maggot] lives in the ground and eats and spoils *ganguri* (yam). In the painting adjacent to *wurrkadi* are the "holes" where *wurrkadi* goes in. The holes are also the place where items used in cleaning wounds are put. *Gululultja / wurrkadi* comes to them.

The third of Mandjuwi's paintings (Plate 7.8)²⁵ shows two transformations of the spirit being, Wuluwuma on the right and Yajurryanjurr on the left. In this the focus is entirely on the gathering of the yam *gulaka / ganguri*. The *mokuys* (dead ones/spirit beings) are assisted by the doves and watched by butterflies. They carry the long digging sticks which are perceived to be transformations of both the yam and the Banumbirr pole.

Another Gälpu man told me of a Morning Star pole that he had in his home which was very precious to him for reasons he himself explained,

I am Gälpu. and we have Morning Star. It comes from Burralku, what we think is the place where all our dead dance there. Our Birrimbirr goes there when we are dead. When a man dies we cut off his beard and send to other group like Golumala, and they make Banumbirr and give to me or my sister and start crying cause that's my father. I can send it back to them to renew it. If I pass away they keep that and show the kids and so on. I think Burralku is something like heaven, but here on earth, an unseen place. Sometimes we call it an island. The bible talks about at the final judgement. Burralku, that's the place for waiting.

In these comments he displays attempts to bring together the Christian and Yolpu concepts of Heaven and Burralku respectively, and in his final sentence arrives at what appears to be a completely new interpretation. It is interesting to see where the focus of his discussion lies in his comments on family and his beliefs in an afterlife. Any perceptions of *mokuys* (spirit beings) or of the travels of the Morning Star are irrelevant. This was not so for the other Gälpu speakers nor for the things that the two senior Djambarrpuyngu men had to say. For them, names, actions, and relationships were the centres of interest.

²⁵ Also in Caruana (1989:109).



Figure 7.2. Sketch of
Djambarrpuyṇu Banumbirr

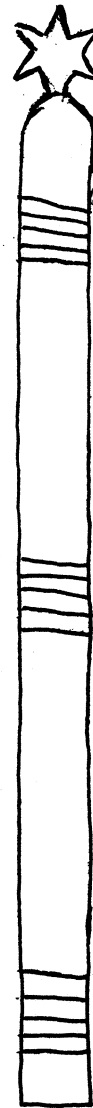

Figure 7.3. Sketch of
Rirratjṇu Banumbirr

Djambarrpuyṇu ideas of the various types of Banumbirr.

Bäni Gulipawuy explained, as he drew Figure 7.2, that there is a wide variety in form of the Banumbirr constructed by different clans. He said that the Djambarrpuyṇu Banumbirr starts on the salt side where the *mokuy* (spirit being/dead one) named Bukudila or Yarrwani sings it at Goṇuruy, although it earlier came from Gundalmirri and Manarrmanda to Goṇuruy. From there it travels

to the north of Goṇuruy. At Munyana it goes high. At Gonyami is high, then show at Nurruyurtjurr. Then it is pointing to Djarraya and then pointing to Galiwinku. [See Map 7.3] Then it becomes daylight and goes back to its same place at Buku-dila.

Dhapdhaṅ is the name for Djambarrpuyṇu Wutjara Banumbirr. It is a single star and also a string.

Guyula / Liya-dhalinymirr Djambarrpuyṇu is different. It has three stars. Gälpu, Djapu, and Umbakumba and Rose River have long string and three stars. also a long pole. Murrūṇun is like that but separate.

Buyu-djarrak is different again.

Our one is *märr dhumbul*, (a bit short) has *starmagutji* (lit. eye) at the top and the pole has rings of feathers around it. [See Figure 7.2] That light calls out the country as it goes along. We sing the salt way.

Dirramu ṇayi (male he) Banumbirr. Mawuka is flower and yam *duyṇa*. Can link star to *djarrak* (terns) too.

From Galiwin'ku, Banumbirr is Murrūṇun and goes further West. They have *raki*, (string) not *dharpa* (pole) from here, Murrūṇun, to Gunini, and Marrawurra and Binydjuwa (country names)

Murrūṇun close to Rramingining different, start again. Their's is very long.

One on \$10 note is Gälpu (short one). I can't use him, pick up their one. Got own. When him finish (some unspecified person), can make Banumbirr. *Näthil* (Before) put him in cemetery. Saw that when I was a little boy at Milingimbi before the war.

Naymil, Djapu and Gälpu sing Gundalmirri. From Gundalmirri brings up daylight *bondi* (quickly).

Another senior Djambarrpuyṇu man²⁶ also insisted that Banumbirr was "outsidepuy". That is it belonged in the open camp, not in the restricted men's ceremonial area, but outside, because it was not *madayin* (secret ceremonial) and the women and children watch it.

²⁶ Quoted in Chapter 1 in relation to Change and Transformation.

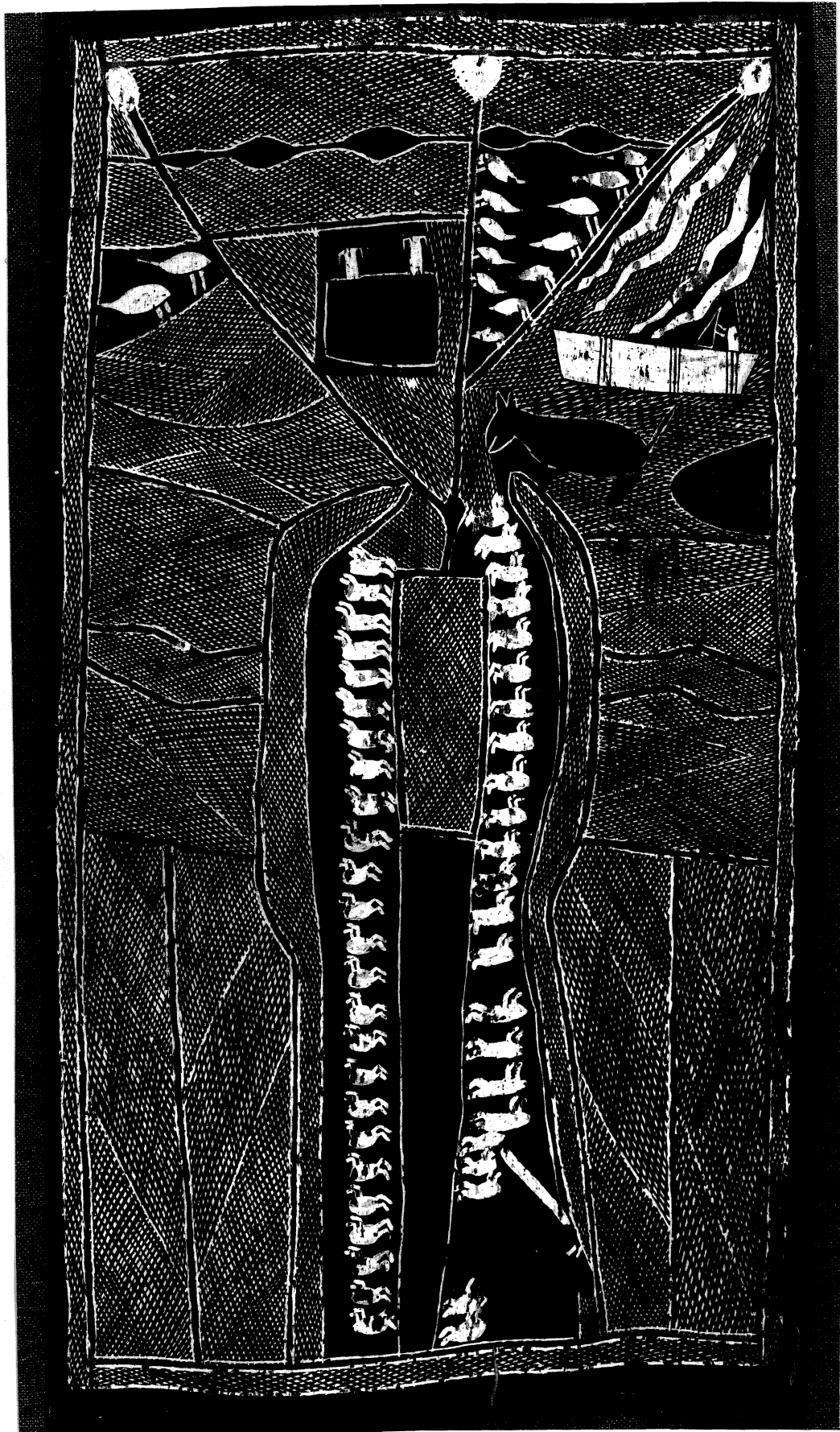

Plate 7.9. Djapu painting of Banumbirr by Maw'. (Art Gallery of NSW).

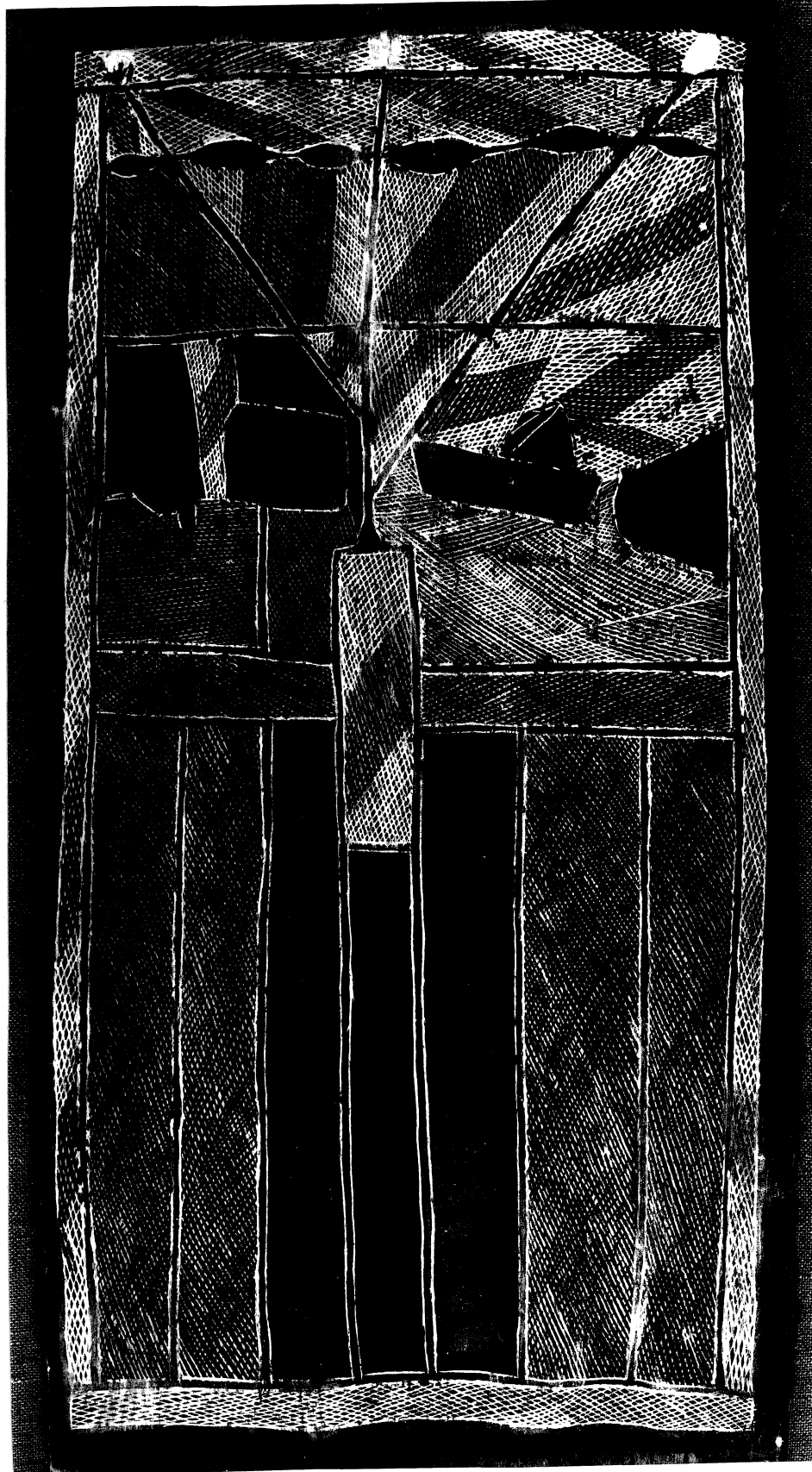

Plate 7.10. More abstract Djapu painting of Banumbirr by Maw'. (Art Gallery of NSW).

Djapu Connections.

The Art Gallery of New South Wales allowed me to use photographs of two paintings made by Mäw' in 1960 (See plates 7.9 and 7.10). I was able to discuss these with Daymbalipu, who is senior son of the artist's oldest brother. The original story supplied with the painting is as follows.

The Morning Star Ceremony is associated with the dua moiety spirit island of the dead at Buralgo where two spirit women let out the Morning Star on strings.

The dancers of the ceremony are shown in two lines on each side of the ceremonial ground, at the top of which is a representation of a high post to which three strings are attached, the dancers holding the free end. (At the end of the dance the strings are committed back into the sky to three positions commonly occupied by the Morning Star. The consent of two spirits depicted on their island above the dancers, is always necessary for the strings to reach the Morning Star). A yam, the food of the spirits, is shown horizontally at the top. On the right are two men on an island and Jawalngura in a canoe. Also shown are brolgas, water snakes and a dingo. The cross hatching represents dust from the dancing."

The paintings, identical except in their degree of abstractness, are masterpieces of the encoded message in the same way as was able to be shown with Wadaymu's painting which was discussed earlier. Apart from the bracketed second and third sentences of the second paragraph above, the story (not discussed) was confirmed by Daymbalipu. These two sentences remain a mystery to me as they are not supported by anything I have encountered concerning the Morning Star.

As described by Daymbalipu, the painting depicts Djapu truth at a number of levels. First there is the story of Yawulngura's journey to Burralku represented by him in the canoe, by the two women (Gurmyinngu and Yambuyambu) he left behind on Gayawukawurru Island and by the dancing of the Morning Star that he discovered at Burralku, where they dance very hard day and night. At a second level of meaning, the dancers are the Dhänbul people and the pole is called Dhämbul²⁷. The Dhänbul people were the original inhabitants of the Yirrkala area and the painting is a depiction of them dancing the ceremony both as real life people in the past and as dead people at

²⁷ Note the slight change between the two names.

Burralku. Their leader was Manyguluma, Garratjuna, and Goṅ-bilma. At a different level, the dancing shown represents the Djapu people dancing the ceremony. The edges of the dancing ground that enclose the dancers have meaning as that which encloses, so that when seen as the transform of the yam, *yukuwa*, growing in the earth of the homeland centre the edges of the ground represent the homeland centre itself. *Yukuwa*²⁸ is human food and ceremonial object. In contrast to this the yam painted across the upper section of the painting is *buwaka* or *yukuḍa*, and is food for the *mokuy* (dead ones/ spirit beings).

Rirratjiṅu ideas about Banumbirr.

The Rirratjiṅu clan based at Yirrkala had a number of different things to say about Banumbirr.

"We," said Witiyana's father, as he drew a picture of his clan's Morning Star, "make the ṅaraka (core) the same as Njaimil [clan]. In painting it is the same, but the feathers are different."

We use a wooden star instead of feathers. The patterns of four painted stripes around the pole are Rirratjiṅu. The ordinary name for the pole is Guyulun, and Dhurupu is our special name. The star, the *yoṯu*, (child) is named Milwurruru, Djämbut, Banumbirr. (See Figure 7.3).

He also made the following connections between Morning Star, Djaṅ'kawu, and a bible story,

"In Rirratjiṅu, Banumbirr more deeper is Djaṅ'kawu. When on sea paddling, looking for land, saw the morning star rising up on sea and it break up the night - after that saw sunrise.

Those wise men in the bible have same story - saw star guiding.

Star tells about new creation before the daylight in both stories.

Only the picture the same.

The Djaṅ'kawu are under Christ because didn't make anything bad."

In this passage there is another example of the constant struggle the Yolṅu have as they seek continuously to find the relationships between any one thing and everything else, and to see where the new can be related to the known. Here we see

²⁸ *yukuwa* is *Vigna lanceolata*.

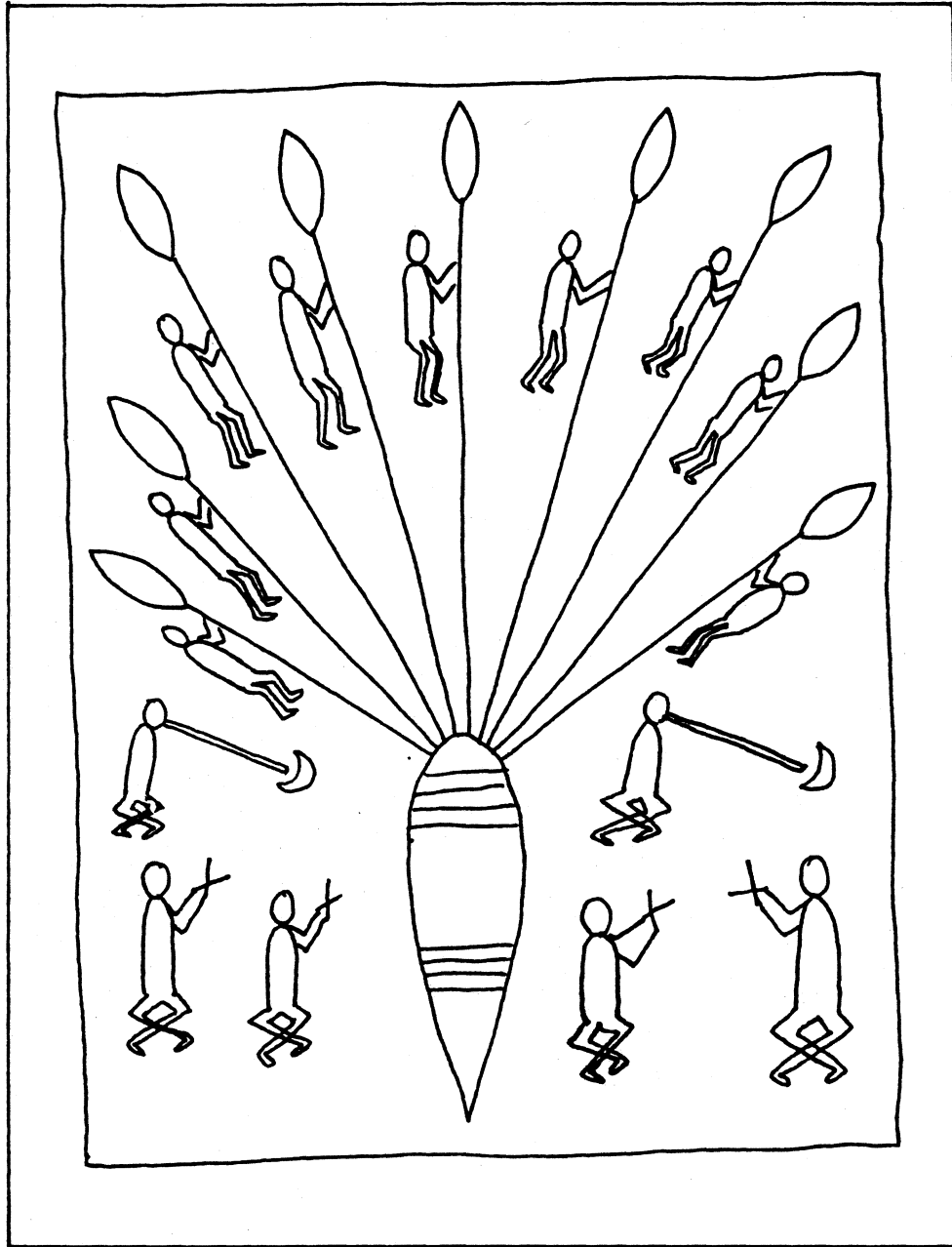

Figure 7.4. Sketch of Mawuka painting by Banygul.

yet another attempt to pull together Christian teaching and aspects of Yolŋu religion. If Christ is Lord and all he does is good, then the Djaŋ'kawu who brought good relationships and ceremonial must be related to him. (That is, they can't be evil).

The Rirratjiŋu use the yam called *Mawuka* (*Ipomea graminea*) as a transformation of Banumbirr. There was a painting of this yam in the craft room while I was at Yirrkala and I made a brief sketch of it (See Figure 7.4.) which I was later able to discuss with the artist's sisters, Balŋayŋu and Mämburra (Banduk). Balŋayŋu said that,

The strings on the *Mawuka* (wild potato) belong to each clan. Some clan may have long string some may have the short string. ("Maybe Rirratjiŋu, Djapu and Marrakulu have long and I think the others have shorter strings"). Some may have the short string off the Banumbirr. *Mawuka* is for painting- not make it. It represents Banumbirr. The yam is only found on Bremer Is and a little jungle area at Yipilana. Rirratjiŋu and the Djambarrpuyŋu from Bremer Is sing the songs of *Mawuka*.

These people as you see in the painting are making a potato. The other man is singing and the other man is playing a didgeridoo. They are making the potato with feathers and strings while other people are dancing. The food is mostly found at Dhambaliya (Bremer Is) which is not far from Yirrkala. The branches represent the homeland centres which are Dhuwa country only. "The clans are Rirratjiŋu, Marrakulu, Djapu, Djambarrpuyŋu, Dhudi Djapu, Liya-gawumirr, Marraju Dätiwuy, Ŋaymil. Nine altogether.

Here *Mawuka* is spoken of as synonymous in meaning to Banumbirr.²⁹ Balŋayŋu listed the names of nine different clans linked by the Morning Star as yams. These however are not the only clans involved and from a variety of sources, it is possible to trace Banumbirr to other Yolŋu clans and beyond that to other peoples who have relationships with the Yolŋu and I examine this wider distribution further.

Clans Linked by Banumbirr.

During my enquiry I have had Yolŋu supply me with ten different lists of the clans who have Banumbirr, though on no occasion did I attempt to encourage

²⁹ There is an apparent conflict between the two paragraphs as in the first she says it is not a made object, just a painting, and in the second the painting is described as being of the yam being made. This can be resolved if the English word "made" is a translation of the Yolŋu word "*buma*" which can mean both "make" and "collect or gather". (It is apparently not collected as food). Another equally possible explanation is that she was referring to the Rirratjiŋu women's rights. That is, they are allowed to paint the picture but not to make the object.

Chapter 7. Banumbirr : The Cosmos Portrayed.

them to list all the clans that were involved, but simply relied on the collection of spontaneously listed clans. The longest of the lists included eleven clans and the shortest, five, but when the lists are collated there are altogether twenty-three clan groups named. Keen (1978:222) lists eight clans with the Morning Star and one of these is not included in any of my own lists.

Warner (1937/58.39-51) who made his observations between 1926 and 1929 recorded a list of twenty-two Dhuwa clans, of which fifteen are said to have "Banumbirr" as a "garma totem". Later (p401) he speaks of one other not included in his lists of clans making sixteen altogether. Of his sixteen, eight are not in my list, which proves nothing more than that they were not included in any of the lists I collected. Collation of the three sets of lists produces a total of thirty-two altogether that are said to have Banumbirr. An additional aspect of particular interest is that one of the most consistently named clans in my lists (seven out of ten) is not listed by Warner as having Banumbirr. This is my Murrugun (his Marungun) from south-west Elcho Island. If this is a mistake of omission on his part, that is one thing, but if his list was correct at the time, it means that at some time during the last sixty years they have acquired it. This remains as a possibility, particularly when it is noted that in several stories of the travels of Banumbirr towards the west, it is Murrugun country that is the last area visited by the star. Firstly Murrugun on Elcho, and then Murrugun further west. This would accord with William's (1986:38) comments concerning the way in which extensions to the mythological paths are made.

While considering Warner's list it is also worth noting that at the time he made his notes he listed Gapiny (his Kapin) as a single group speaking Naymil (his Mukkanaimulmi) or Gälpu, which are both dhanu languages the same as Golumala. It is possible that here is a hint that the three currently separate clans that are part of Gapiny may have only a short time (the same sixty years) during which they have laid claim to separate identities.

My suggestion is that there is a good possibility even if the data is tenuous, that at least some sections of the Banumbirr complex could be quite recent in development in comparison to the normally perceived antiquity of Yolŋu mythology. This idea is supported by the description quoted earlier, associated with the Warrukay transform of the Morning Star, that implied that it was a myth which was only as old as the mission (founded in 1942). In practice it is not the antiquity of any aspect of the Banumbirr complex that is relevant to the Yolŋu, but its usefulness in terms of communicating awareness of the inner reality and its effectiveness as a political tool.

In Wadaymu's story and other narratives, the Morning Star was listed as travelling west as far as the Murrupun. Further to the west, and beyond the fringe of the Yolŋu linguistic group, Clunies Ross recorded the Morning Star amongst the Anbarra who speak the "Gijingarli" dialects of the Burarra language, who live near the mouth of the Blyth River. By the time the complex has been communicated this far west "Guyulun" has become the common name and Banumbirr (their Bornumbirr) is an alternative name, and in this western area, the star is described as being definitely female. The sugar glider is still associated with the star, though now named "barranyji"³⁰. The transformation of Warrukay is as mentioned earlier, now called Larreja by the Burarra. It still maintains the same physical appearance in both paintings and sculpted forms but is glossed in Wild (1986 Guyulun Bark No 1) as sawfish and in Clunies Ross (1988.19) as "a large fish wanjarr from the open sea".

In the same area the Rembarrja artists, represented in the Australian Museum in a collection from Maningrida, make both bark paintings and Morning Star poles, though in this collection the poles are named Mularra.

In Wadaymu's story it was also listed as travelling west as far as the Murrupun. Other evidence of an extension of the complex towards the south of Yolŋu country is only sketchy but nevertheless indicative of a spread to Numbulwar (Rose

³⁰ barranydji in the north east was described to me as a long whiskered possum, different from the sugar glider.

River) and to Groote. An earlier quote from a Djambarrpuyŋu man listed the star as travelling as far as Umbakumba (on Groote Eylandt) and Rose River to the south. Waddy (1988:156) describes a link between Bickerton Is and Groote through *dambul* (a Yirrkala name for the Morning Star pole) which was described to her as "a stick or piece of wood to which feathered strings were attached" and likens it to the Maradjiri pole described by Boorsboom (1978:167). Waddy (1989:102) also lists the name for Venus (the Morning Star) as "Barnimbirra". Turner 1974 describes Dambul as a hollow log coffin decorated with parrot feathers and string and made by the spirits of the dead which was brought to Groote via Bickerton Island from Murujun country on the mainland south of Blue Mud Bay. It would appear from just these brief references that the Banumbirr complex has been used to establish relationships not only within Yolŋu territory, but beyond it at least to the south-east, south and west.

So it can be said that the Morning Star Complex has been used as a tool to establish and maintain relationships throughout the whole Yolŋu block and beyond that to non-Yolŋu neighbours in at least three directions. This is completely in keeping with the Yolŋu attitude towards boundaries of any kind. That is they are found by them to be an anathema. If these peoples outside the Yolŋu block speak different languages and live in somewhat different ways, then it is important to find a way through these obstructions. The Morning Star is just one way of achieving this.

To this point, I have examined the Njaimil and Gapiny perspectives and considered some of the connections to other clans, while simultaneously describing some of the ways in which the complex is used and revealing some of the basic analogical references contained in the complex and its transforms. The analysis of this material will be considered in more depth in the final chapter. Some of the questions which have not been examined are concerned with the mythological basis of the complex. Is there one myth or are there many? If there is variation, of what kind is it and what causes the variation. Some parts of these questions have been answered in

general terms but I now consider them in relation to a number of versions of the myth that are available and some of which have already been published.

NARRATIVE VERSIONS.

Considered in summary, the complex as I have shown in the earlier part of this chapter describes the star being made by a *mokuy* (spirit being). This star is sent out each day before dawn and at daylight is hauled back on its string by a woman who stores it away in her basket where it stays until its next journey. To this outline a wide range of elements can be linked by the narrative, and as I have shown, any of these can form the focus for a further set of linked ideas. In this way the outline of the complex can be expanded by a wide variety of supplementary details according to the contextual needs of the situation. For example, the star in its journey can be explained as stopping at, or visiting certain sites that are linked to named Dhuwa moiety clans. This then is given as the explanation as to why these clans nowadays make the ceremonial object, and are related together through it.

The earliest published version of the story comes from Warner (1937 / 58 : 524 - 528) who gives a comprehensive version of the Banumbirr (Morning Star) myth which I have summarised in Appendix G.

Warner gives no indication as to whether this narrative came from a single speaker, though it appears to be a compilation from various speakers. On the basis of the wide variety of stories that I have heard, overheard and recorded over a long period of time, it appears to me that the normal approach to story telling is to take a potential core for a story and arrange around it any of a wide range of details. If one listens to a story about a single subject from two different narrators, each can tell the story in such a way that any or sometimes even most of the details that appeared to be the core when it was told by one, are omitted by the other. Warner's story appears too comprehensive and to have too many foci to have come from a single speaker on a single occasion, and he gives a hint of this in the first paragraph of the story where he

notes a difference in details supplied by different narrators.³¹ His version forms a useful baseline for comparison with subsequent versions that have been recorded by myself and others. I have divided it, for the sake of comparison with other versions, into six episodes.

The first part of Warner's story which recounts the journey to and from Burralku corresponds to a story told to me (mostly in English) by Mathaman Marika at Yirrkala in 1967, and jotted down as he told it with only two brief references to Banumbirr. I include the complete story in Appendix B for comparison with the above.

As can be seen from a comparison of his story with the one recorded by Warner, there is little mention of the Morning Star in Mathaman's version. He focuses his story on the journey of Yawuljura to Burralku and back, with its verification of the existence of the place of the dead. So the Morning Star itself, focus of other versions, is almost irrelevant here except for the one brief mention. The details of sections 3 and 4 of Warner's narrative which deal with the star's guardian and the star's journey are completely omitted.

Thornell (1986.62-64) tells a version he recorded, apparently also at Yirrkala between 1938 and 1944, which is very similar to the one told by Mathaman. It too omits sections 3 and 4 of Warner's account. In Thornell's version it is a branch of a tree that brings the message to Yawuljura [his Yaulngoro]. As in Mathaman's version,

he leaves his wives at Djurrwanbuy Island [his Jirwanboi], travels for days following the rising of the Morning Star, knowing that this will lead him to Burralku [his Baralgor], comes to an island where he digs for turtle eggs, is surprised by an evil spirit, and leaves hurriedly to continue his journey to Burralku.

³¹ One other aspect of Yolju story telling is that from version to version details may change without there being what can be considered as *the* correct version. The *correct* version is always the one being narrated at the time of narration. Whether Warner's version is a compilation or not, the details he recorded would have been *correct* when they were told.

Some of the details of the actions at Burralku differ. In Thornell's account (as in Warner's) Yawuljura is given a positive welcome by the people there, met by "the great Bapa" (*bäpa* = father) who tells him he was sent for "so that you might return and tell your people of this place" and then returns home.

In Mathaman's story there are details of the things he sees and the dances he performs, but he is met by Mälumbu and Yambuyambu and definitely not welcomed. Only in Mathaman's version are there specific details of food taken for the return journey. In both Mathaman's and Thornell's he reaches the island and collects his wives, in both he tells his story and in both he dies shortly after. In Thornell's story there is the extra detail that one of his wives has given birth on his return. Thornell records that his death is due to illness, Mathaman that it is from sickness due to over-eating turtle eggs.

When these two versions are compared with the corresponding sections of Warner's record there appears to be disagreement about the clan to which Yawuljura is said to belong, Warner says he is Gälpu while Mathaman says he is Naymil. These are closely allied clans, and as both speak the dhañumirri language it is possible that in some circumstances both could be referred to as Gälpu. Warner mentions the outer island, but no leaving of wives there on the way, while the other two narratives record the same name for the island and leaving of the wives. Warner notes that there is variation between informants concerning the length of the journey and this is exemplified in the three narratives, with each placing different emphases in different places.

It becomes obvious that there is a dearth of any sexual comment in the two journey narratives, while these are explicit in Warner.³² Warner also records that Yawuljura brought with him from Burralku a Banumbirr "emblem which was made

³² I would suggest that the probable reason for the difference here lies in the fact that at the time of recording both Thornell and I were missionaries and prior to the seventies sexual aspects of life were considered as not normally appropriate to discuss with mission staff, but suitable for discussion with non-missionaries.

of seagull feathers and the yam" (both of which were apparently separate made objects, though the record does not specify this) and there is no mention of anything like these in the other two narratives.

The section of Warner's story, which concerns the Morning Star's journey, is related to the story told on tape by Wadaymu of the Njaimil clan and recorded at the beginning of this chapter. He was one of the men referred to by Mathaman as belonging to the same clan as Yawuljura. The story he tells gives some details of the myth and although the narrative is told as the outward journey of the star, the focus is on Banumbirr as a ceremonial object, and with relationships between clans and land.

When Wadaymu's story is compared with Warner's version there is agreement between the two in that in both Banumbirr is a made object which travels from East to West, visiting the territories of certain clans. Beyond this however the comparison fails. There is a major difference in focus in the two. In Warner's version the actions of the figure Yawuljura are the centre of interest. In Wadaymu's story there is an explicitly stated focus on the Njaimil clan homeland centre where we have Banumbirr being made by Yawuljura. This is then used as a base for the activities of Banumbirr as a Wajarr (spirit being). It is described as having a wooden *jaraka* (core) with arms of tasselled strings. After being made powerful Banumbirr has a life of its own, and throughout the narrative can be interpreted as a spiritual entity which by its journey and actions is establishing relationships between clans.

This notion of the place of Banumbirr in the relations between clans is the focus of a further recorded discussion which I had with Galpagalpa of the Djambarrpuyju clan. He, like Wadaymu, described Banumbirr as being made at Gundalmirri, but he gives the being a different name, saying both, that this being made it at Gundalmirri, and that Yawuljura made it at Burralku. This can be interpreted in two ways; that Gundalmirri and Burralku are two names for the same place, or that the one spirit changes its name according to location. Like Wadaymu's story, the contents

of this discussion refers to the origins, ownership and journey of Banumbirr. It also reflects the political aspirations and relationships of the narrator.³³

In Galpagalpa's version of the story (Appendix H), he focused it to emphasise the Golumala clan's claim for significance. He states that Wili, the then senior member of that clan is boss for Banumbirr. On this basis of Golumala rights he is then able to claim rights himself through his mother's mother's brother. The last paragraph, a sort of addendum to the story, emphasises first the relationship between the ceremonial complex and the star in the sky, then goes on to question the reality of Burralku.³⁴

There were other men from different clans whose comments on their clan's versions of the Morning Star myth produced some details which matched well with details of the above narratives and some that were quite different. One of these, a Gälpu version, is included. I have recorded it as a variant narrative although it was really a discussion of some of the details of Gälpu paintings of the story (See Plates 7.7 and 7.8.). It is included to give an indication of the range of variations. The problem raised by the ambiguity in Galpagalpa's comments is partly answered here by some of the statements made about Banumbirr by Yalkarriwuy. Though I recorded no further full versions of the myth, the importance of the other variations needs to be carefully considered. Yalkarriwuy said that Banumbirr was made first by Wuluwuma and that the whole object also is *ganguri* (a yam) and its *gurrkurr* (strings /sinews) were the yam creeper.

In his Gälpu version, the Banumbirr is reported as being originally made by a Gälpu clan *mokuy* (spirit being/dead person) at a Gälpu site. However there are two subdivisions of the clan relating to separate geographic territories and with the

³³ The full vernacular text with translation is to be found in the appendix. I have extracted from it as much as is needed for a coherent set of information for discussion

³⁴ This same type of suggestion about the veracity of Burralku has been made to me by a number of senior men over the years. There appears to always be a degree of scepticism about the facts proposed by others, so whether their questioning is a result of their commitment to Christ, or whether the existence of Burralku has always been questioned, can only be guessed at. There is no way now of ever knowing, as all but one of these old men have now died.

best recording that I could do I was not able to consistently distinguish whether he was speaking of one *mokuy* or two. It appears as if he explicitly states that these are two names for one being, the separate names being names given by the two Gälpu groups, with the names being related to the *mokuy* at their own site. In the painting however, they are represented as separate individuals, drawn differently and recognised as discrete. On a different occasion the same informant said that Banumbirr was made at Burralku alias Dhunumbiyala by a *mokuy* for whom he gave five names, none of which matched either of the above, but some of which matched names given by other Yolŋu. (See Table 8.4).

Yalkarriwuy's comments show a completely different emphasis from all the previous narratives, because his focus appeared to be on the spirit being and on Banumbirr's association with a particular yam. In this he commented on the nature of the being, its actions and behaviour patterns, and various aspects which form the particularly Gälpu section of the complex. Each of the species names are also names of dances and songs which are danced and sung by Gälpu clan members at times of ceremony, such as funeral wakes.³⁵ In his description some effort has been made to communicate sets of alternative names for different elements of the story. Again, names are demonstrated as having importance in terms of their ownership and in terms of their capacity to focus the associated network in the interests of the clans owning the particular sets of names.

In the variations found between the six versions discussed here, there is clear evidence of the ways in which stories in general differ in their narration according to context, and of the purpose of such variations. There is quite obviously no such thing as one correct version. Each clan, and in fact each individual, has a separate agenda which is among other things, always related to rights and their maintenance. Each of the narratives discussed, apart from Warner's version, places

³⁵ At such times they dance the various actions of their spirit being, such as digging yams and slapping mosquitoes.

particular emphasis on the speaker's own interests. Where other groups are mentioned, the priorities of one's own group in relation to the others appear to be inevitably attended to as part of the focus of the narration. As far as the Banumbirr complex is concerned, the narration of the story is manipulated on every opportunity to the speaker's own advantage, while giving the impression that the focus of attention is on the star.

CONCLUSION.

In this chapter I have now established some of the basic details of the Morning Star Complex. There are three stars in the sky, each of which is named Banumbirr. I was not able to identify the first two of these although the third one, variously referred to as the real or main Banumbirr is the planet Venus. It is this that comes up from the inside in the east, and it appears to be true to say that this forms the basis upon which the whole complex has been developed through a process of analogical transformation. The five basic facts which were outlined in the introduction as forming the core of the complex can now be seen to be used differently by different clans. The location in which the original Morning Star is claimed to have been made has been shown to be clan specific, and relative to whichever clan a particular Banumbirr belongs. The generalised site, Burralku (which appears to refer to spiritual rather than physical origin) may be named as the place of origin, or the Morning Star may be spoken of as beginning at the specific clan's homeland centre.³⁶

On the basis of these variations and other supportive data, it is possible to deduce that there is not simply one Morning Star being spoken of, but a number. Each of these refers to a constructed ritual object which appears to have been used as a tool for the establishment of relationships between clans. It is possible to explain the outworkings of the long "journeys" described as being made by the star with two variations of a single theme.

³⁶ This latter was shown to be the case for Gälpu and Djapu, Njaimil (with Dätiwuy and Golumala) and Djambarrpuynu clans, each of which was able to claim their own site as the source for the construction of Banumbirr.

When a ceremonial gift is given it is a part of a whole ritual, including songs and dances, and accompanied by the whole. The ceremony is received by those who are to receive the object. Sometimes such a given object is wrapped and stored as a whole item. This is apparently quite common treatment nowadays with the establishment of permanent dwellings where they can be stored. (Inside and out of the reach of small children). Alternatively, as the identity of such an object is "in" the strings with which it is decorated; these may be unwound off the core, the core buried or otherwise disposed of and the strings stored. As shown in Chapter 3 there is an analogue in this of the disposal of the dead. This is between the persons *ṅaraka* (bones) and the object's *ṅaraka* (core) and between the ongoing existence of the identity of both. When required again for ceremonial, such stored strings used to construct an object, would in fact construct one with the same identity.

My best understanding of the journey then is the giving of an object (original or reconstructed) in a chain of successive ceremonies from one group (and hence one site) to the next. A *ṅaymil Banumbirr* or a *Djapu* or *Gälpu* or any other named *Banumbirr* would then be identified with the group by which it was originally constructed and given. The fact that there are a wide variety of differently constructed *Banumbirr* would support this.

Linked to *Banumbirr* I have shown also some of the transformations of it which are either used as support for, or alternative statements about the established relations by different clans in different ways. I have also argued that the ownership of these various elements and transformations within the complex are manipulated in a variety of ways. These include using them as tools to think with, instruments to teach with, and as support for argument in the struggle for political advantage over other groups.

In the final chapter of the thesis which now follows, I complete as far as possible the analysis of the complex. I attempt to analyse in more depth some of the

Chapter 7. Banumbirr : The Cosmos Portrayed.

analogical references and transformations associated with the complex as they can be established from the material available.

CHAPTER 8: CONCLUSION.

TIMELESSNESS AND CHANGELESSNESS.

MODELS OF THE COSMOS.

Banumbirr as cosmos model

Elements of the Complex

Clan Perspectives on Banumbirr.

**Banumbirr as a complex of Entities relating to the Inside
of Reality.**

Messages of the Complex - Analogues of the Cosmos.

Entry into the inside.

The Afterlife.

The Passage Through Life

The Place and Nature of Man.

The Place and Nature of Woman.

The Nature of Existence / Identity.

The Banumbirr Complex as a Model of the Cosmos.

Human Relations as Cosmos Model.

Relations with Land as Cosmos Model.

CONCLUSION. THE MODELLED COSMOS.

CONCLUSION.

In pursuing the analysis of Yolŋu cosmology I have shown, in line with the general definition discussed in Chapter 1 of this thesis, that the Yolŋu cosmos is an ordered whole with its own unique framework of concepts and relations, a framework which brings descriptive order to the whole and to man's place in it. The analysis has been applied to a series of major conceptual areas, the structure of each of which has been shown to be related to presuppositions made by the Yolŋu particularly in relation to change.

It remains now to draw together these separate analyses to demonstrate how each separately forms a model of the overall cosmos and how each separate model forms a part of the whole. In the sections which follow I first examine how the presupposition of changelessness has influenced the notions of time and identity, and in conclusion discuss the models of the cosmos which are carried by the Banumbirr Complex and by Yolŋu relationships with both man and with space before drawing together the composite model which they present.

TIMELESSNESS AND CHANGELESSNESS.

I have shown that the continuum of time and the measurement of time while of great importance in Western thought are largely irrelevant to the Yolŋu, and that this very irrelevancy is of major significance in understanding Yolŋu cosmology. Absolute time in Newtonian terms is apparently not considered, each event being located according to its co-occurrence with or its relationship to known events of three kinds. These are, the recurring events of the earth itself, the physically and socially marked events of the passage through the human life and those events which can be described as revelations of the "inside" reality. The recurring events of the earth include the fixed events of sun, moon, stars, winds, rains, heat, cold and plant and animal growth patterns.

Some of these were shown to be named in series. For example sections of the day or seasons of the year, each of which is a qualitatively identified event or time location to which any other significant event can be related. The human events were shown to include both those of the normal physiological stages and also those that are sociologically constructed and celebrated in ritual of one kind or another. However it has also been shown that while noteworthy events can be located in relation to human life stages or in relation to earth events, it is more important to locate them in relation to geographic space.

There is a problem, for the analysis of the Yolŋu approach to time, which is generated by the juxtaposition of the presupposition of changelessness with the facility to locate events in relation to the human life stages or the recurring events of the earth. This problem arises largely from the fact that the relation of events in terms of human life stages and earth events appears to be structured in fundamentally the same way as the Western approach to time measurement and therefore such location of events is seen by the Western observer in terms of time.

In contrast to this, such location of events by the Yolŋu is, while a location of them in relation to reality, a location of them in relation to a largely atemporal cosmos. In doing this, the location of events in terms of geographic space is what is important, and this can be in relation to either or both the inside or outside aspects of the cosmos. Because reality is considered by the Yolŋu in terms of location in space, it is the geographic space aspect and not the time aspect which is the focus of attention, the location of events associated with both the inside and the outside of reality being related to this.

As I have demonstrated in Chapter 6 the continuum of time is of no relevance beyond the present cyclical or human event and one adjacent category of event, and this is the limit of precision possible. It is in this level of the location of events that they are usually seen in relationship with the outside aspect of reality. What is significant here is the relationship between the events and not the time but the space of occurrence. Beyond

the relationship between the events and not the time but the space of occurrence. Beyond this limited range in distance, a shift occurs and any events of importance are seen in relation to space and their significance is seen in terms of the inner reality. In this way all events of significance are transformed by their nature into an atemporal state.

Such events as are recorded, recognised or celebrated then become a record of human relationships and usually human relationships at the level of the "inside" reality though the outside aspects are not discounted. Such relationship events as are remembered and passed on, then become a record of relations with the inside aspect of reality, losing any temporal and eventually even sequential reference more and more as they become distant from the present.

In this way, historical events such as the visits of the Indonesian trepang fishermen from Makassar, or even the more recent movement of the Golumala clan to Galiwin'ku township become associated with events described as being *baman'* (at the beginning, far distant) and eventually become incorporated with what white people have called "The Dreamtime", the "inside" reality, losing all temporal reference except far distance and gaining present location in the inside reality. The presupposition of changelessness is then not in conflict with time conceptualisation.

I have shown that a relationship exists between cosmological existential presuppositions and perceptions of (or interpretations of) the cosmos in which it appears that the presuppositions determine the perceptions of the cosmos and the subsequent conceptualisation of it. As a result of this it appears that there is strong support for an argument that suggests that the various social, religious and cosmological structures used by the Yolŋu are presuppositionally determined. This would then support Mary Douglas' claim, quoted earlier that each cosmology or world view is a theory which "has its hidden implications" (1973:173). This being so it should be possible now to give some indications of the effect of presupposition on the perception of the cosmos and of the perception of identity within that cosmos.

In Chapter 1, I cited a statement made by Rrurrambu in response to my enquiry as to the most valuable thing to Yolŋu people. He said that this was knowing his identity, where he fitted and who and what he was. I argued there that for Yolŋu people identity was defined in terms of relationships and that this included relationships between families and clans but also kinship relationships with places, natural species, some other things and sacred items of a wide range. Not only are human identities defined in this way, but also the identities of all the things to which humans are related.

Yolŋu identity as I have shown is defined in terms of the individual's perceived relationships to other people (including groups), to place, to the *madayin* (sacred emblems of all kinds) and to the other living elements of cosmos although the particular use of any of these four categories is relative to the context in which a definition is being made and any of them may be the most significant (at a particular time) depending on context.

Humans appear to have identities at a number of different levels. Each person has a discrete identity as a human individual while some aspects of that identity are concerned with the identity of the clan of which that person is a part. The whole clan has a single identity so all parts of the clan share that same identity though the most senior men (and occasionally women) represent the most complete manifestation of the clan's identity. One consequence of this is that when there is conflict between clans it does not matter which member of the clan is retaliated against as each is equally a manifestation of the clan. Similarly each lineage has a corporate identity of which each individual is, potentially at least, equally a part. Again, the children of one woman, who have the same father, share a common identity which is a composite of aspects inherited through both the matriline and the patriline.

If as Jordan (1974:275) says the identity of an individual can be defined as the "location of the self in a particular world of meaning, both by self and others...a product of interactions between individuals and social structures and individuals and

others", and if identity is a social construct (eg Berger & Luckmann 1966:194) and "individuals construct their identity by locating themselves within a particular model" (world of meaning) (Jordan 1988:109), then security of identity is dependent on the security of the model or models of the cosmos maintained by the group and the individual. According to Christie (1988:3) it is of prime importance for Yolŋu people to be involved corporately in "discovering together and living out their Aboriginal identity". There is then a constant corporate and individual interaction between a group's cosmology, their identity as a group and their identity as individuals within the group.

In the case of the Yolŋu with their presupposition of changelessness this interaction is able to be interpreted as an ongoing process of discovery and revelation of the identity which is. Thus hypothetically this means that all relations including power relations are eternally fixed and those who hold power do so by right of a sort of eternal decree that says, "This is the way it is". In practice however this is not the only approach that arises out of the notion of changelessness¹ and it can equally be asserted that if an individual or group is able to gain an advantage over another, (by fair means or foul), that that gaining of advantage must have been part of the eternal reality of changeless identity or it could not have happened. Thus the presupposition of changelessness is able to be used to justify and explain both the control of power relations and their reversal; the position of disadvantage and the gaining of advantage. If taken to their logical extension this includes the continuous political manoeuvring for the gaining of control over sacred items, land, and the reproductive potential of women and hence the increase in power of various groups over others and all able to be justified in that it is the working out of an eternally established state of changelessness. It is as Bos has suggested that that which is now must always have been true otherwise what is now could not have come to be as it is.

¹ Stanner (1963:168) makes an almost identical observation concerning the Murinbata.

Throughout the preceding chapters one Yolŋu presupposition has been emphasised more than all others; that is that there is no change. This is spoken out by Yolŋu in many different forms and presented in many ways. I have repeatedly had older men say that the *rom* (law, lore, way, system, ultimate truth) does not change like white man's laws but always stays the same. Then in the extended conversation with Rurrambu he emphasised, using the metamorphosis of the butterfly as an example, that no matter what outward shape he may have appeared in to his father, he had not changed but simply gone through a transformation. This presupposition was shown to apply particularly to the notion of human identity as being unchanging.

Particular results can be seen in the perceptions of the passage through life. If the identity is without change then what is always was and always will be. In human terms, if then a person always was and always will be, that person has to have existed somewhere before conception and has to exist somewhere after death. Therefore, presuppositions of a location for humans who are non-visible are a predictable consequence. These in the Yolŋu case have led to a further basic presupposition of the cosmos as having two aspects; a visible, tangible existence which is outside, where all observable phenomena are experienced, and an inside, invisible, intangible existence which is normally not able to be experienced, but which under special or abnormal circumstances may be experienced or which may be experienced by special or not ordinary individuals (for example *marrŋitjimirri* [those with familiar spirits]). I have shown how these concepts of "outside" and "inside" existences or sides of reality are quite broad concepts which are interpreted in a variety of ways with their meanings to a large degree dependent on their context or the way in which they are focused.

When Yolŋu observe the changes which happen to an individual through a lifetime, the presupposition of changelessness causes these to be interpreted not as changes, but as developmental transformations which reveal further aspects of the already fixed and unchanging identity. The implications of this are that all living things including

humans are seen to go through a series of transformations, each of which is a more developed expression of the identity than the previous one. Consequently when this is combined with observations of the passage through life, the inevitable conclusions drawn are that this is a one way passage with normal human life as the particular event during which the full expression of identity becomes manifest just prior to or at death. Death then becomes an entry into the fulfillment of an eternal identity. There appears to be no room here for the development of notions of re-incarnation.

Another consequence for cosmological understandings based on the changelessness of identity is associated with the place of an individual human in relation to all other humans. A child is born into a fixed place in the network of relationships which is established by the kinship network. As a result the individual's relationship to the entire cosmos is fixed at birth. There is then absolute security for all conforming members of society in knowing who they are. The gradual revelation of the full extent of that identity is made clear to each individual in an ongoing ritual context, and for the men, in periodic contact with the "inside" aspects of that identity in the men's "inside" ceremonial ground with its ongoing revelation of further degrees of "insideness".

A combination of the presupposition of changelessness with the notion of transformation leads to the idea that one identity can have more than one manifestation; potentially an unlimited variety of manifestations. As each manifestation is (not has) the same identity as every other manifestation, an identity can potentially be expressed in a number of different forms simultaneously. Similarly with the presupposition that parts of an object have the same identity as the object, whether that object be a stone, plant, animal, human or implement, any part has the same identity as any other part. This then is at least a partial answer to the problem of "participation" which bothered Lévy-Bruhl for the entire course of his writing.

What I have described as analogues throughout the thesis can from this perspective be understood to be separate transformations of single identities and it

appears possible to say this even when speaking of a ceremonial complex as an analogue of the cosmos, or a ritual object as an analogue of a man. It is for this reason that I have not described them as symbols, for the notion of symbol implies one entity represented by another. As transformations one of the other this understanding is a natural outworking of the presupposition of changelessness.

It is then in the understandings of the nature of identity that this presupposition appears to have its greatest affect. By asserting the transformation of unchanging identities of all kinds in contrast to a perception of identities in change and then working this through in the various models of the cosmos that are used, change and time are able to be made irrelevant. The results of this in terms of models of the cosmos remains now as the final investigation of this thesis.

MODELS OF THE COSMOS.

Banumbirr as cosmos model

The documentation that has been presented, in the previous chapter demonstrates that Banumbirr is not a single precisely defined identity, but rather a complex system of interrelated ideas and practices identified with, and having the name of, the Morning Star. The complex includes myths of origins, song poems and ritual forms and objects each of which can be seen both as a representation of, and as a transformation of, the star. In all of these there are implied cosmological presuppositions, and like all Yolŋu activities, each presentation in any of the varied forms has political implications.

There are conflicting views concerning the sacredness or insiderness of different aspects of the complex that appear to be relevant to different contexts. However the sacred aspect according to the prevailing climate of my investigation was obvious only in regard to the actual ceremonial objects, and to certain names that are owned and restricted in their use. As far as meanings were concerned, there appeared to be no clear discrimination made between inside and outside meanings and there appears to be no clear

boundary between inside and outside. Thus it is possible to say that there are aspects that are clearly "outside" and others that are clearly "inside" and an area between the two which at all time remains open to interpretation.²

In contrast to these views was the attitude of the young Gälpu clansman who spoke of his having a Bañumbirr in his possession which had been made using his own deceased father's hair. This was too important for public display and there was the same reticence towards its being photographed as there is shown towards photographing some of the very sacred objects from the secret ceremonies. Keen (in a personal communication) notes a very similar attitude applied to a similar pole made at Milingimbi and incorporating the hair of a deceased clansman. This particular attribute of sacredness may well be linked to the Bañumbirr's association with the particular deceased clansmen, as the corpse of a deceased person is considered to be a sacred object. By incorporating some part of the deceased in the construction of the object, this sacredness would automatically be incorporated in the object as well.

My intention in examining the Bañumbirr complex has been to examine enough of it to give some idea of its complexity, and to probe as deeply as possible the meanings and understandings of the cosmos that are incorporated in it. I expand the analysis here, of the material presented in the previous chapter, to demonstrate the ways in which this complex functions as a map of the cosmos. I show how it presents a series of facets of the Yolŋu understanding of the Cosmos, and in doing so, functions as an analogue of the Cosmos. I have at no stage attempted to cover all the aspects of the Bañumbirr complex. Any list of the associated song subjects would make it obvious that I have covered neither songs nor their subjects and I have no intention of pursuing them here. There is a great deal of potential for research in any of these complexes and it was beyond the limits of my own work to attempt to be more comprehensive.

² For example, two of the senior Djambarrpuyŋu men, Bāni Gulipawuy and Bapawun quoted in earlier chapters explicitly stated that Bañumbirr was "outsidepuy" (belonging to the outside) and so not sacred.

Elements of the Complex

Analysis of the data presented to this point reveals that there are a number of recurring elements across the different versions of the complex, and that some of these recurrences present a different name for the same functioning element. In addition it is overtly stated that certain elements of the complex are considered to be the same as, or in an analogical relationship to, certain other elements.

The following elements appear to be basic to the complex; a. the tasselled pole, b. the basket, c. a male spirit figure frequently named Yawuljura, d. a female spirit figure generally named Mälumbu, e. Burralku as a location which is both source and destination of the star, f. the journey of the star, g. the star and h. the attached string. Supplementary to these are elements which function as transformations of the tasselled pole. These are, i. the yam plant, and j. the barracoota. Each element has its separate interpretations or sets of interpretations and meanings. The interpretations and significance of these analogical relationships will be examined in more detail as the analysis proceeds.

Each of the elements of the complex is seen as having potentially at least the interpretations shown in Tables 8.1, 8.2, and 8.3. While the listed elements appear to be basic to the complex in North East Arnhem Land, particularly as displayed in association with myth and painting, and these are the ones for which I was given interpretations, they are not all the elements involved. In addition to them a number of others have been referred to in passing. These include; *ratjpa* (haematite ore), *gudurrku* (brolga), *bonba* (butterfly), *birrkpirrk* (masked plover), *gukuk* (bar-shouldered dove), *milk milk* (mosquito), *wurrkadi* (an unidentified grub or maggot), *wäraŋ* (sugar glider), *damala* (eagle), *djinydjapana* (dolphin), *gunga* (pandanus tree), *banumal/ganinyidi/dhurrtjithurrtji* (a digging stick), *djarrak* (black-capped tern), *gadayka* (stringybark tree).

Element	Interpretation
The tasselled pole	as ceremonial transformation of the star in the sky as yam plant as barracoota as male reproductive organs as particular ancestor as clan line as pattern of relations between clans
The basket	as both source and destination of star's journey as storage place for the star as place where clan transforms from inner to outer reality as female reproductive organs / womb as that on which the clan continually depends as the earth in which the pole is planted as the earth in which the yam grows as the place (in <i>warrukay</i>) where little fish go inside as the place (in <i>warrukay</i>) where good and bad are sorted.
Yawulḡura	as one name for an individual or spirit being named separately by each clan or group of clans as creator of the pole as founder of the clan
Mälumbu	as guardian of the star and basket as bearer of the clan as clan's nest / womb.
Burralku	as the place of origin as destination of spirit of the deceased as each clan's special site
The Journey out and back	the movement of the star the movement of a human spirit out from and back to its ceremonial site the reciprocity between groups in the giving of women, and ritual objects the reciprocity between groups in the exchange of human hair and ceremonial items.
The Feathered Tassel	represents the star on its string represents a human spirit and its relationship to a site. represents a yam flower represents a manifestation of a clan member represents a clan site in the clan's territories represents a whole clan
The String.	that which connects the star to its source that which connects the set of sites that which connects the clans sharing Banumbirr that which enables a reciprocal return to be drawn back "relationship" itself.

Table 8.1. Interpretations of the elements of the Banumbirr complex.

Element	Interpretation
whole plant	as Banumbirr as the family line as the whole clan growing and branching.
roots (<i>luku</i>)	as plant growing into the soil as foundation (<i>luku</i>) of the clan as original ancestor as ancestor's genitals
flowers	as feathered tassels as stars as manifestations of clan members as clan sites in territories as whole clans
stems	as strings on the morning star as the identity of the clan running through generations.

Table 8.2. Interpretations of the elements of the yam transformation of the Banumbirr complex.

Element	Interpretation
Whole fish	as pole to the morning star as both male and female as burial pole
Basket inside	where little fish swim in where good and bad are sorted.
Backbone	as poison as ferocious nature of the clan

Table 8.3. Interpretations of the elements of the barracouta transformation of the Banumbirr complex.

Each of these elements appears to have its own significance, although not all are relevant to all the clans that have Banumbirr. Each nevertheless functions as a subsidiary link between the clans which share it as a common elements, and it appears that, depending on the context, each is potentially a focus for the establishment of, or maintenance of relationships.

Clan Perspectives on Banumbirr.

Each piece of separate data from a clan or individual is a statement from that clan's or speaker's perspective, and each statement about Banumbirr reflects something of

the individual's use of Banumbirr as a political tool. A Naymil speaker uses it to emphasise through the story's narration, the veracity of his claims to ownership rights in the parts of Galiwinku where there are haematite deposits. So he uses the Banumbirr story to focus a complex network of related details on his own and his clan's identity as custodians, users, and rights bearers in the sites he names. As he is currently the most senior member of the clan, and hence the most complete expression of its identity, the entire cosmos is centred on the importance of his identity of a single individual. He brings about this focussing by pulling the strands of the network in such a way that the ones that support his statements are emphasised, and the ones that support other clan's claims are de-emphasised and made to appear less supported than his own.

Golumala clan members and a Djambarrpuyju descendent from a Golumala woman placed high emphasis on the fact that their clan is represented by the strings in the central position that are wound around the core of the Banumbirr pole. Based on this they present the separate attachment of strings representing other clans to the central strings on the core as an analogue of their position in the organisation of relations between clans. In this way they attempt to focus an almost identical set of facts in their own direction, thus emphasising the importance of their own position as a clan. They also link the central position of the strings on the pole as representing their clan, with the notion of the pole as being a transformation of Warrukay (barracouta). To this they also link the existence, in the Haematite section of the Galiwin'ku town area, of an important Warrukay (barracouta) site as evidence of their affiliation rights in the site. They have emphasised this relationship between their clan and this site by establishing a small burial ground on the site in which deceased members of their clan, and some from politically important supportive clans have been buried. Naymil clan (mentioned above) who also "have" strings on the pole itself, and also "have" Warrukay (barracouta) both as a transformation of the pole and as a large hollow log coffin made similar claims by naming their clan as having that central position on the core and adding Golumala claims in a de-emphasised way. In this way each clan attempts to draw the focus of agreement and the centrality of

position to their own clan's case, while implying but carefully not ever stating that the other clan's claim was of less veracity than their own.

There is a further way in which prestige and priority appear to be developed through the Banumbirr complex, and this appears to be related to position in the sequence of the movement across Arnhem Land. Wadaymu's claim for the Naymil Banumbirr as starting at the Naymil site at Gundalmirri is used by him as part of his claim for the significance of his group. That is, it is as if he was saying, "This was a Naymil mokuy that made the star and sent it on its travels. See how important we are that this important Wajarr can have started with us. We have power here. We are people of power." He is in this, working hard to establish the importance of his clan in relation to others, using its origin in his country as a basis for his propositions.

Gälpu and Djapu men raised the same argument as a basis for their own importance, but laid claims for the original construction of Banumbirr to have been at a site jointly owned by these two clans. While there was agreement between the two in terms of the place of origin, each of these clans has their own names for the mokuy making the original Banumbirr and when they talk about it they do so using their own names for different aspects of the complex. In this way they are emphasising their own rights and their own significance as a clan.

It is of interest that members of one of the largest groups, the Djambarrpuyŋu, saw little need to emphasise their own importance in this complex and in fact, while telling the story of a Banumbirr made by a Djambarrpuyŋu *mokuy* (dead one/spirit being) in their own country at Goŋuruy one of the senior men remarked that it had really come there from the Naymil site at Gundalmirri. In some ways, this de-emphasising of Banumbirr's significance is a deprecation of the claims of clans whose claims for importance are based on its use.

Banumbirr as a complex of Entities relating to the Inside of Reality.

Within the Banumbirr complex there are different kinds of inter-related spiritual entities which are not always clearly distinguished from one another. The more I attempted to analyse the information given to me about these different kinds of entities, the more complicated the situation appeared to become to the point where it became (outside of context) almost impossible to determine absolute categories of anything. It is possible to arrive at some general definitions but never to be certain that the parameters of such a definition include all that could or should be included and exclude all that should be excluded.

It is possible to speak of *mokuy* (dead ones/spirit beings) and *wajarr* (spirit beings) and *djamarrkuli'* (lit. children/ or a sort of nebulous, partly defined kind of spirit) and I have attempted to give some outline of these concepts in Chapter 2. However when any precision of boundary is attempted for these definitions, they will not work, so that all descriptions of such entities revolve back to being clear only in context, and not always then.

A lot is said about the *mokuy(s)* (dead ones/spirit beings) associated with the Morning Star, and the term *mokuy* itself has been shown to be both singular and plural simultaneously. When a *mokuy* is being referred to it can be difficult to discern whether what is being referred to is a single entity with multiple names, or one of a series of named entities. For example, in Galpagalpa's narrative he refers to two different names for the *mokuy* who makes the Morning Star, Yawulḡura and Guluthumbirr, but distinguishes them as different by saying that Yawulḡura makes it at Burralku and Guluthumbirr who makes it at Gundalmirri. It is not clear however whether these are two names for one *mokuy* with one name specific to each location, or whether there are two discrete individuals involved. To complicate this further is the difficulty of knowing whether Burralku is an analogue which refers to each homeland centre or not. Galpagalpa gives

some indication that Burralku is not thought of as a real place which could mean in terms of outside reality.

Sometimes, what appear to be personal names for discrete beings are treated as general classificatory terms. For example, Goṅ-bilma (lit. hand clapstick = Always Singing) appears to be a euphemism for "songman" and used as both a personal name and as a sort of general term. At other times a whole series of names appear to be given to the same individual or class of individuals by Yolṅu from different clans, with each clan having its own names for some, and sharing other names with other clans.

Table 8.4, gives some indication of the complexity of this naming process. The list itself is not useful as a basis for forming theories about the names as it is simply a collation of the names given in my presence by members of the named clans. The two spellings of Dhanbul and Dhänbul are retained as I recorded them as they could be dialect differences. I have earlier discussed the two names used by the two Gälpu groups and again it is difficult to be certain whether these refer to two discrete individuals or whether they are separate clan names for one.

The use of the wide variety of different names for *mokuy* (spirit beings) in the different versions of this complex also raises the question of exactly what it is that the various names are referring to. For example, when the different uses of the name Yawulṅura are considered, the question that arises is whether this is the name of a man or a spirit being. It appears that in at least some contexts he was an ordinary Yolṅu man. There are two activities of his that are described as the actions of an ordinary man. The first of these is in the journey he makes by canoe to investigate a yam leaf brought by the wind from the east. The second is his action in making the Morning Star dancing pole at Gundalmirri. The first speaks of him unambiguously as a human male who visits Burralku, the place of the dead, returns to his family, then dies and becomes a *mokuy* (dead one / spirit being).

Source	Clan	Mokuy Name	Site
Wadaymu	Naymil	Yawuljura Goj-bilma Dhanbul	Gundalmirri
Bäni	Djambarrpuyŋu	Yarrwani Bukudila	Gojuruy
Daymbalipu	Djapu	Manyguluma Garratjuna Goj-bilma Yawuljura	Burralku
Yalkarriwuy	Gälpu	Dhänbul Wudulaŋiny Yuwaypuma Manyguluma Nydila	Burralku Dhunumbiyala
Yalkarriwuy	Gälpu Monukpuy	Wuluwuma	Nandjijura
Yalkarriwuy	Gälpu Raypinypuy	Yaŋurryanurr	Nandjijura
Warner	Gälpu	Yawuljura	
Galpagalpa	Golumala	Yawuljura	Burralku
Galpagalpa	Golumala	Guluthumbirr	Gundalmirri

Table 8.4. Table of clan and site location of mokuys said to construct Banumbirr.

In the second reference, made during the narration of the story of the construction of the Morning Star pole, he can be interpreted as either man or spirit. There is also ambiguity in the use of the word *mokuy* (dead one / spirit being). This leaves any interpretation open as to whether the description is of a man who has since died, and who

thus from the present perspective is a deceased human and hence a *mokuy*, or whether what is being described is the action of an independent spirit being, also called *mokuy*. Such spirit beings are usually described as carrying out human activities, although often in an exaggerated way.

In addition to the complexities in identifying what is referred to as a *mokuy* in different contexts, there is the possibility of a different set of multiple meanings linked to them. This appears as a possibility when the different versions of the manufacture of, and journey of *Banumbirr* are compared.

The series of different descriptions and maps tend to indicate that there are a number of different *Banumbirr* ritual objects being described, in conjunction with a series of exchanges between groups. If this is correct and I have collected descriptions which emphasise this as being so, it would appear reasonable to suggest that in some cases at least these multiple names for *mokuy*s could be the names of different human individuals who were responsible for the construction of the different ceremonial objects. As they are all now deceased, they are all now *mokuy*s (dead ones / spirit beings) even assuming that they were originally all normal Yolŋu men.

*Mokuy*s are not the only spiritual entities involved in the complex. At one level *Banumbirr* is the name of the Morning Star in the pre-dawn sky. At other levels it can be the general name for the complex, or the ritual pole and the string. However in *Wadaymu*'s story the *Banumbirr* is spoken of as being changed by *Yawuljura*'s actions. By painting, decorating, singing and dancing, this *mokuy* figure "makes it powerful", and in paragraph four of his story *Banumbirr* is named as being a *wajarr* spirit being. At this level of interpretation we are confronted with a perceived transformation of the outer, physical *Banumbirr* so that it becomes the embodiment of a spiritual entity of the same name. Keen (1978:230) also records this discrimination between such *wajarr* Beings and their, "everyday equivalent such as Red Goshawk Being and the red goshawk".

In this way the one name is used for different transformations of the one thing, so it can be difficult to know which form is being referred to. In contrast to this there are times when each of several transformation of a single entity has a whole series of names and this may include a number of sets of names with each set being used by one or more clans but not by all clans. Any one of the different elements of the Banumbirr complex can thus have multiple names or multiple sets of names, all referring to the same entity or to some aspect of the entity. Without the references being given with the names, that which is referred to is able to be kept secret.³

In some contexts the star itself and its transformation as the feathered tassel on a string are referred to as a child and as such also as a discrete spiritual entity. It was described earlier as also representing a transformation of the yam flower and as an individual clan member. This child entity,⁴ here appears to represent a sort of pre-emergent or undefined human spirit that has not yet developed or assumed the complexity of spiritual entities which is the adult human.

"Man" is the last spiritual entity I wish to consider here, in this multiplicity of spiritual entities concerned with the Banumbirr complex. Man, and here I am referring exclusively to the male of the species, is a unique complex of spiritual or "inside" entities. This was exemplified particularly clearly in the two stories of Wili's arrival at Elcho Island. One described him as a man coming with the first missionary, while the other described him as *Warrukay* (the barracouta) coming from his homeland centre at Njada'yun. One story spoke of him as a man, while the other spoke of him in terms of part of his spiritual identity as Barracoota. This is however only one part of his spiritual identity. He is also Yam, not just as an analogue, but as a part of his being, He is also

³ As Keen indicates, (1978:179) when such elements are danced (or sung) reference is being made not just to the species or items, but to the *waparr* beings of the same name and disposition. Thus in the Banumbirr complex, the Morning Star is associated with a whole "pantheon of *waparr*" spirit beings, (to use Keen's phrasing) each of which functions to form different sets of links between distinct groups of Dhuwa clans.

⁴ defined further in Chapter 2 under *djamarrkuli* (children)

Morning Star Pole, and Genitor for his descendents, so each of his children is a replication of his own spiritual identity. It has been suggested to me in passing by some observers that the Yolŋu believe in re-incarnation, a suggestion that the Yolŋu explicitly deny, and this appears to be a misunderstanding of the nature of the multiple *wajarr* that make up a person's spiritual identity and the handing on of names. In the same way as *warrukay* is the name for one barracouta fish, it is also the name of the identity "barracouta" which is both singular and plural. The children of a man carry on his identity of barracouta, not replicate the identical spirit fish which was him. The passing on of names is frequently from one living person to another and sometimes there are as many as three or four people with the same name living at the same time. Again this is not an indication of re-incarnation but of shared aspects of identity and in a Yolŋu sense of being part of each other.

In pulling together this apparent confusion of possible interpretations I now propose an approach which appears to allow all the different accounts to stand as they are while bringing a further level of understanding. That is, that all the different accounts are based on a mythologised religious history. With this as a basis for explanation, the different *mokuy* can be considered as being the men who made the different ritual objects in the different locations, but who, being now dead, are *mokuy*. Within only a short period of time, (perhaps as little as a single generation) it is possible for them to shift from one side of the domain of meaning of *mokuy* (as dead one) to the other side of the domain of meaning of *mokuy* (as spirit being). The different wooden poles are all representations of the same star and of the same spiritual entity, all of which have the one name "Banumbirr". Each different clan has a set of spiritual entities. These overlap with the sets that other clans have, but each maintains its own identity by retaining its own unique combination of entities in the form of *wajarr* spirit beings. In this unique set is the make-up of the unique identity of individual clans and their adult members, and it appears that the security of the clan's identity is dependant on the control of this uniqueness. If the set of spiritual entities is able to be matched by any other clan then their uniqueness of

identity would not only be seriously threatened, but completely lost. So Banumbirr is not just a network in terms of the links between different *waṅarr* beings, and between different clans, but a network of interlinked networks associated with the separate sets of links between clans, established not through affiliations based on natural objects, but on shared relations established through the various *waṅarr* beings.

Messages of the Complex - Analogues of the Cosmos.

As the Yolṅu person in possession of the full range of possible interpretations, (if such a person exists), considers the meanings of Banumbirr, he is able to see within the complex a considerable range of information about the nature of being, including the nature of the cosmos. I do not consider that the interpretations of the elements of the complex shown in Tables 1.1 to 1.3 are in any way exhaustive although I have attempted to be as comprehensive as possible. One of the aspects of such a complex as Banumbirr is that because of the structures of analogical comparison, it is always possible for the complex to expand, if by no other means, then at least by using analogue as a tool to meditate with.⁵

Using the interpretations listed earlier in this chapter, combined with the data in this and the preceding chapter, it is possible to analyse a series of messages concerning reality as being communicated by Banumbirr through the medium of analogy though acknowledging that the communication of specific meanings is likely to be entirely relative to the context of, and particular aspect of, the complex under consideration. I consider a number of messages one at a time.

⁵ As discussed earlier, for the Yolṅu this would not be considered as making new additions, but as recognising a truth that had always been there. The reason for this lies in the structure of analogical thinking, which is also both the process and the tool used by the Yolṅu for the incorporation of change. Because any analogue is considered to be the same as, or qualitatively equivalent to any other analogue of the same thing, any analogue is able to be considered as being equally as true as any other. Therefore, as I have emphasised earlier, if it is new, it will be considered as having always been true, and as being simply new to the observer. In essence it can then be thought of as a new revelation of eternal truth, or of the inner reality. (Bos 1988:392)

Entry into the inside.

Starting with Wadaymu's bark painting of Banumbirr as a ceremonial object, and his narration of its journey, we find that Banumbirr was made in Burralku which is an analogue of and hence equivalent to the Naymil clan's homeland centre. Because the pole with its feathered strings attached can represent the clan itself with its founder and the attached strings represent the clan members as they come out from him it speaks of the clan's origins as coming from the clan's homeland centre. During ceremonies the pole is at times planted in the earth. It is then connected to the earth in the same way as the yam transformation of the pole is related to the earth. That is, opening it, penetrating it, and being inside it. With the pole or yam functioning as a representation of the penis, the earth being penetrated by Banumbirr then forms an analogue of copulation. This same analogue was implicit in the narrative as the male spirit makes Banumbirr powerful by singing and dancing with it, while the female spirit cries for it and has her sleep spoiled by it. Implicit also in this analogue is a further meaning concerning the relationship between the clan's sacred *rannga* (ritual elements) which are kept inside the water at the clan's homeland centre (one penetrating the other) and the relationship between the maintenance and care of this relationship and the growth and strength of the clan. The clan's sacredness, identity and actual members, past and future are inside at that site.

The Afterlife.

Entry into the afterlife is also analogous to entry into the "inside", and to reuniting with the *wajarr* beings that are associated with the homeland centre. This uniting with the *wajarr* is graphically illustrated in the construction of the Gälpu Banumbirr described in the introduction to this chapter in which a deceased man's hair is incorporated as part of its construction so that the man, represented by part of his body, and the Morning Star *wajarr* (Spirit Being) become a single unit. To plunge the pole into the earth then becomes an analogue of the man's entry into his homeland centre and hence into the afterlife.

If the various analyses of the analogues are applied to the bark painting by Mäw' (Plate 7.9.) there are immediately a number of interpretations of the painting made available by the analysis, which reveal by analogue a number of perceptions of the painting.

- a. The figures in the painting are men dancing on the ceremonial ground.
- b. The figures are *mokuys* dancing at Burralku.
- c. This is the yam penetrating the ground at the homeland centre.
- d. This is the Yam Being (and simultaneously a member of the clan) going "inside" at the homeland centre, and being celebrated by the *mokuys* there.
- e. This is an analogue of copulation.
- f. Therefore the dancing ground is a reproduction of female reproductive organs.

Because the act of copulation is an entry into the "ultimate of sweetness" in the woman's body, then death can be considered to be movement to a place which can be described as the place of ultimate sweetness. This place, described as Burralku, is an analogue of the homeland, the place where the clan's yam grows and where the *rannga* (ritual objects) are kept in the earth.

The entry into the inside which here means into the afterlife, can be interpreted as analogous to the pleasures of copulation. As a result, as a man approaches his own death in his old age, through his meditation he is able to see this as a positive step to the place where the Banumbirr myth describes endless dancing (a euphemism for copulation) and the enjoyment of good food in abundance (eating being another euphemism for copulating).

The Passage Through Life

When the men are dancing with the pole and tuck the pole into their crutch as they dance with it, the pole was explicitly stated to be representing an erect penis. The action simultaneously represents Mälumbu pulling the string attached to the star back into her basket, which is the inside of her reproductive system. This dramatised analogue

gains more power when Mälumbu is recognised as an analogue of the earth (or a particular site) as mother from which the child spirit (represented by the feathered tassel) comes looking for its human mother.⁶

Because the star can be considered as a transformation of the identity of any clan member the act of Mälumbu letting out the string attached to the star from her basket and then pulling it back into it speaks of the clan member's movement through life as being a journey in which he or she comes eventually from Burralku (alias the clan's homeland) and returns again there at the end of the journey⁷. It therefore also speaks of the journey and the passage through life as being out from and back to the clan's homelandcentre.

The Place and Nature of Man.

Throughout the Ba_umbirr complex, man is shown as the genitor in whom exists the full identity of the clan and who is responsible for the continuance of the clan and of the spiritual identity of the clan. Portrayed in the *mokuy* creator of Ba_umbirr he is shown as the one who manufactures the pole and makes it powerful. This is the pole that carries the Morning Star (child) to the various homelands centres. Here is a fairly explicit picture of a man's erect penis bringing children to his women, and man is quite clearly portrayed here as a physical being. Man is also as the pole and its various transformations a spiritual being whose identity is a composite of the various *wajarr* spirits represented by the transformations.

The Place and Nature of Woman.

Woman is represented in the complex as the place in which the clan develops. She is the clan mother and portrayed more in this role than in her role as a sexual being

⁶ One woman said to me that her father had actually told her that when he dreamed of her conception, he dreamed of her as the Morning Star coming to her mother.

⁷ As was more fully explored in Chapter 3.

though the latter aspect is much appreciated. Her reproductive function is to receive the child from the man. This function is portrayed in various ways, as the woman who stores the star in her basket before letting it out, as the basket inside the barracouta into which the little fish (children) swim, and in a painting by Wunuwun (in Caruana 1989:95), as fish swimming into a fish trap.

While the man's responsibility is seen in terms of the genitor, it is the woman, as daughter of the clan, who is responsible (as I showed in Chapter 4) for passing on the clan identity through the matriline, and it is the women who will carry the spiritual identity of the clan inside them for three generations before it comes outside again.

The role of woman is portrayed in each of these ways in the complex although the focus of the complex appears to be not on woman at all. Her function is given the appearance of being peripheral to it. To draw out more from the complex than this could lead to the error of imputing more than the complex actually communicates.

The Nature of Existence / Identity.

Banumbirr has been shown to have a range of transformations which is potentially unbounded. As a statement this implies certain things about the nature of existence. Whether an identity is an object like Banumbirr, or the identity of an individual person, it is considered to be an unchanging permanent identity that always was and always will be. Change is seen to be not in the identity, but in the potentially unlimited or even continuous transformations in the expression of that identity.

The Banumbirr Complex as a Model of the Cosmos.

The Banumbirr complex can be regarded as one model among many models of the Yolŋu Cosmos. Whether a single aspect of the complex is considered in isolation, or the complex is considered as a whole, there is a statement being made that, "This is the way it is." The various forms of the complex are in this way direct expressions of the

cosmological presuppositions of the Yolŋu. These assumptions will be considered in a later section of this chapter. Here I wish to examine the outline of the cosmos that is portrayed by Banumbirr, to consider the "This" of the above statement, the perceived reality.

As I mentioned in the first chapter of this thesis, one man, in attempting to sum up the nature of a cosmos in which all things are understood to be in relationship with all other things, said to me, "You should use the word 'network' ". As I continued the research I began to realise how apt and carefully thought out was his choice of the English word. There are aspects of a net which enable it to act as a suitable analogue of the cosmos in that a net can be considered as a series of points connected by strings.

In some ways similar to a net the Yolŋu cosmos viewed from the perspective of a single moiety is formed of a network of points linked together in all directions, and the Yolŋu not only speak of ceremonial connections between clans as strings joining them, they use actual decorated strings to demonstrate these connections. This also is quite clearly demonstrated in the Banumbirr complex where the strings wound around the core and the strings connecting the feathered tassels to it are used as visual statements of those relationships. Again, the string on the star let out from Burralku speaks of connections between the "inside" and the "outside", of the living and the dead, it links clans and clan sites on its journey. Here however, the "net" analogue breaks down and "network" becomes more appropriate as there is no simple quantitative equality in the pattern of interconnected points in the cosmos which would compare to the mechanical arrangement of spacing in a net.

The Yolŋu in attempting to explain the patterns of connections and relationships which make up their cosmos, frequently resort to the analogical use of the structure of plants, not quite in the same way as these are used in the Western construction of "tree diagrams", but in three other ways. The first of these is similar to the use made of the yam plant as seen earlier (Figures 4.15, and 4.16), which has something

like a single origin from which comes a series of successive branchings, though in some the paintings, notably that by Wadaymu (Plate 7.1) the yam is shown with multiple roots. A second structure drawn from plants is based simultaneously on two separate aspects of a tree's structure. There is the overall pattern of the tree's growth with its branching roots, a single trunk and then the branches above, then there is the notion of the layering of outer bark, inner bark and still further inside, the wooden core. The one further way in which I have had them used to demonstrate relationships was a drawing made by Daḡataḡa (Figure 4.17) in which he drew a series of yams side by side with each representing a separate clan, and then interwove their branches so that these formed a similar sort of network to that formed by the overlapping branches of trees in a forest. This was drawn to demonstrate the ways in which the clans associated with Baḡumbirr are interlinked through a series of marriages over a period of time.

Within these three structural analogues there are several important notions which relate to the Yolḡu perceptions of the nature of the Cosmos. First there is as I have mentioned, the notion of connections between points which are described by the Yolḡu as "relationships". Then there is the notion of "focus". In the tree there is the trunk to which all roots and branches are connected, and in the yam structures, there is a focus in the luku (root or foundation). Imposed upon this notion of focus, is the critically important notion of "identity", for identity, which is seen as unchanging, is also seen as the sum of all of its expressions and connections.

The Baḡumbirr complex exemplifies these notions. The name Baḡumbirr can be thought of as a nucleus, or as a focus. When considered as a focus it can be a point to which all the associated points connect; when thought of as a nucleus, it can be a point from which all the attributes radiate outward towards other points. In Yolḡu practice, both approaches are seen simultaneously. For example the identity of "Baḡumbirr" is seen to be star, plus ceremonial object, plus yam, plus clan, so that when any one of these is under consideration, it will be the focus, while all the other analogues remain equally part

of that identity but unfocussed. Each of these transformations connects to Banumbirr and each of them in turn forms the focus of a further network of ideas concerning the nature of the cosmos. While the other aspects are not at the time in focus, they are nevertheless under consideration as part of the whole identity.

Within the complex we find various sets of inter-connected points. There is a set of clans linked by their common sharing of rights in some aspect of Banumbirr and these clans are in turn connected to a parallel set of sites similarly seen to be interconnected through their relationship to the travels of Banumbirr.

At an entirely different level of connections I have shown that Banumbirr itself acts as one focal point with connections of different kinds reaching into many different aspects of the Yolŋu world. There are links to the fields of poetry, music and painting, links to and statements about the nature of sexual relations, procreation, and the roles of the sexes. There are links to other ceremonial complexes associated with such other points as particular spirit beings, various yams, and the barracoota, and each of these other elements can and do form further connections outwards to other aspects of the Yolŋu world. This interconnecting continues until the whole cosmos is formed into a single interwoven whole built out of an apparently endless series of overlapping networks of relationships.

The structure of the cosmos, according to this analysis can be summarised as an unbounded multi-dimensional network of interlinked points. Within this cosmos, the points are held in focus, and their identity defined only by relationships to the network of supporting points. Thus Banumbirr as a model of the cosmos and as an identity, is supported by multiple levels of surrounding points, each of which reinforces the statements it makes about the nature of "The way it is".

Human Relations as Cosmos Model.

As mentioned in the discussions of the Morning Star, and earlier of kinship, the Yolŋu use plant structure as an analogue of human relations. It has also been shown that such analogues are many-layered and that the plants as analogues of the structure of relationships, are simultaneously analogues of the Cosmos itself, each analogue reinforcing the other.

Human relations discussed in Chapter 3 in their transformations across time, and in Chapter 4 in their perceived atemporal state as fixed relations between individuals and between groups also function as a model of the Cosmos; as different ways of making the statement that says, "This is the way it is. Everything is fixed permanent and unchanging".

The individual is born into a fixed relationship with every member of his family and of his clan and through this system of kinship terms is related to all other individuals, clans and by extension, peoples on the earth. He is aware of this from early childhood, each relationship being discovered, named and learned and every new individual fitted into the pattern as he grows.

As a model of the cosmos the synchronic relations between individuals and clans form analogues of the relations between all things in the cosmos. Each individual is connected by specified relationships to every other individual and these relationships whether traceable or attributed are patterned on those seen as established between the closest of kin. Similarly relationships between clans, established through the *ranga* (sacred objects) and the matriline are seen as fixed in such a way that any new relationships established must be new expressions of what has already existed either "inside" or somewhere else. These relations between humans and groups are then extended to the whole cosmos so that all relevant elements are able to be considered as being in a permanent relationship to all other elements.

By extension all things and all people on the “outside” are in relation to all things and people that are “inside” so we have a cosmos which is in one sense divided into an outside and an inside network and in a second sense, a single all encompassing network of related elements with two expressions.

This brings us to an aspect of the of the relationship system which I have discussed throughout the thesis but not drawn attention to prior to this. That is that the kinship system itself is not just a single network, but is structured in a way that is analogous to the relation between “outside” and “inside” reality. That is, while it is a single entity it is also a dual entity. There are two moieties, each with its own mythology, each with its own sacred objects, each ensuring that its sacred identity is passed on through the matrilineal transfer of daughters and each using the other as the mother for its children, with the children of the females of the clan (the *waku*) functioning as the guardians of its sacredness. Thus the relationship between the two moieties forms yet one more analogue of the relationship between “inside” and “outside”. The males of each moiety use the females of the other moiety to ensure the reproduction of their own clan and moiety in a way that is analogous to the “outside” elements of the cosmos entering the “inside” elements (man entering the inside at death) and vice versa (children entering the outside at conception).

The model of the Cosmos presented by the pattern of human relations then depicts the elements of the Cosmos as being in fixed relationship where there is no change. However by interpreting these relations as being in a fixed and stable state in the “inside”, the outer manifestations of them are able to be adjusted , in accordance with any newly revealed “truths” about the inner reality, or in line with political expediencies. Thus change can be incorporated into the network of relationships at any level of description of them while maintaining that there is no change in the "inside" reality of the cosmos.

Relations with Land as Cosmos Model.

Many of the relationships between humans and human groups have exact parallels in the relationships between human groups and land. A child pre-exists at a place which is significant to the father's clan and is directed to the mother who nurtures the maturing child in her womb. She however is part of her own clan's land and because of this her land is then seen as being in relation of mother to the child and hence to the child's land. In this the woman's womb, with the child within, is an analogue of her husband's sacred site within which are kept the sacred objects which are analogues of the clan and of its pre-conception individuals. These "sacred objects" or pre-conception individuals become transformed to become first children and then adult members of a clan that is of the opposite moiety to the woman, the woman's clan and the woman's clan's site. Thus a site of one moiety carries inside it and functions to bring into the outside reality, the sacredness of a clan of the opposite moiety.

This intellectually ought to present a major philosophical problem, as the ancestral beings portrayed in myth as linking sites, and depositing the sacred elements of each clan's identity never cross land of the opposite moiety. This dilemma appears to be solved in two ways. Firstly in the role of *waku* who is both woman's child and also mother's mother's mother's mother. *Waku* is both human and land; sites being in relation to each other in the same way as the humans born from them. Thus by having an inheritance between sites matrilineally for four generations, the sacredness of one moiety is carried inside the other and moiety sacredness manifests itself in alternative matrilineal generations. So the cosmos that is Dhuwa is inside the cosmos which is Yirritja and forms an exact parallel of the understanding of the relationship between "inside" (where things are not manifest) and "outside" (where they are manifest) and the relationship between matrilineally related sites becomes one more analogue of the relationship between the two dimensions of existence.

Pursuing this further, *waku* (both sexes having the same sacred identity) is the one who cares for the mother's clan's sacredness and the mother's land's sacredness, so the *waku* site and clan of one moiety is in this relationship of caretaker and of authority over the sacredness of the mother's clan and land that are of the opposite moiety. The strength of this caretaker role was demonstrated particularly with regard to the Galiwin'ku town site where the son of the last female of the local Gunbirrtji clan was seen as having authority over that clan's sacred objects and land even though it is of the opposite moiety.

The dilemma of the notion of a site of one moiety functioning as the bearer of the sacredness of the other within itself is also met through one of the very things that appear to emphasise the dilemma. That is that the ancestral beings mentioned above as linking sites, and depositing the sacred elements of each clan's identity are said to never cross land of the opposite moiety. Frequently in myth, the way this is described is that the ancestral being either "goes up" at one site⁸ of that moiety or "goes inside" at that site and then "comes out" at the next site of its own moiety, so that within the myth itself is frequently carried the notion of being "inside" while traversing the territory of the opposite moiety.

The relationship of caring exemplified in *waku* (sister's child/woman's child) is also reflected at cosmological level where men are seen as having a great responsibility to care for things that are of the "inside" whether those things are the sacred objects or the deceased person at a funeral. In both these situations again, the *waku* has a primary function.

This relationship of caring appears to be taken for granted as a two-way thing. That which is of the inside is also seen as caring for that which is of the outside. While I collected no overt statements of this type of caring (by that which is inside) it does appear

⁸There is reasonable evidence in the Yolŋu treatment of celestial constellations to suggest that these could be considered as "inside" so that inside is potentially located above as well as below.

to be implied in some of the versions of the journey of the man, Yawuljura, to Burralku and back, particularly in the welcome given to him by those who were there, and provision of women and food for him. It can also be suggested here that when *waku* is caring for his mother clan and its sacredness, it is the inside aspect of that clan carried within *waku* which is doing the caring for its outside manifestation. Since Christianity has been espoused, caring is also one of the most commonly focussed-on attributes of God. He is prayed to as the personal *djakamirri* (the one who has care of) and responded to as one who blesses and brings peace and happiness.

In all this the cosmos is seen as being permanently established with everything in a fixed relationship to everything else. At all levels of duality, outside and inside, Yirritja and Dhuwa, there is not just a fixed relationship, but a fixed relationship where each is not only inside the other, but each has a responsibility to care for the other.

Within the "outside" cosmos sites are identified by a number of aspects. These include their physical attributes, but are generally more to do with the association between the site and those manifestations of the "inside" reality which are related to that place. It is the combination of these manifestations which forms the focus of the identity of any site; the network of relationships between a site and other sites on the bases of kinship and shared mythological entities, is what completes that identity. Because of this way of constructing identity the identity of a site is unbounded in the sense that it is always potentially open for expansion on the basis of further revelation.

This combination of the focussing and networking of relations as a basis for identity is then analogous to the cosmological identification of human beings except in the one detail that humans gain their identity not from relationship with just a single site but from relationships with a networked set of sites and associated ritual elements, the unique combination of which forms the basis for human identity. Thus deprived of land the Yolŋu is deprived of a large portion of the basis of his identity and without affiliation with land is unable to adequately define that identity.

The model of the cosmos presented by or contained within the relationships between humans and sites and between sites is of a two-sided reality each side of which is composed of an identifiable network or network of networks with each of the two sides being contained within the other.

CONCLUSION. THE MODELLED COSMOS.

I have now presented several different ways in which the cosmos is modelled. That is, through the Morning Star complex, through human relationships and through relations between humans and sites and between sites. These can be reduced to two models simply by recognising that relationships between human, humans and sites and between sites are all analogues one of the other so that they form a single model. When this is compared with the Morning Star complex, these are, as would be expected, complementary to each other, producing between them what appears to be an effective cosmological model.

The cosmos according to this model is composed of a potentially unlimited range of elements, each of which has its own discrete identity. Some of these (the presently relevant ones) are recognised and known but there is always the possibility that others will become relevant. All elements are linked together in networks of relationships which in turn form the basis of identity and as a corollary of this, without relationships there is no identity. It is this that is the basis on which the establishment of relationships becomes an imperative.

The cosmos itself has both an inside and an outside aspect, and each element of the cosmos has, potentially at least, an inside aspect which is unchanging and an outside aspect which goes through a series of transformations. It would appear from the ideal of the models presented that the inside is where all things exist in unchanging relationships but that there is a kind of maturing or perfecting process undergone by all living things. This process involves a transformation from inside to outside in an

immature state, progress through a series of transformational stages (apparently always three or multiples of three where these stages are specifically identified) whereby maturity/perfection is reached prior to a final transformation into a state of perfection back into the inside.

For humans part of the outside process of maturing involves the discovery or establishment of the inside relationships with other humans with sites and with sacred elements. It would be possible to argue, though I have never heard it stated, that until one goes through this transformation to the outside, through it, and back inside, existence is in a kind of anomalous state without relationships and without awareness of one's identity, and that it is only by having the opportunity to come outside that the establishment of one's inside identity is possible.

In conclusion then, Yolŋu cosmology projects a cosmos which is an atemporal, two-sided, unbounded, network of entities incorporated in fixed relationships and with both inside and outside aspects, each of which can be discerned as a manifestation of the other, each a transformation of the other and with each being perceived as being analogous to the other. However it is a cosmos that is continually being discovered, as events occur which are interpreted as unknown aspects becoming known, or the more inside aspects of the cosmos becoming established in the outside, the establishment of such aspects being treated as the evidence of both their inside and their atemporal existence.

BIBLIOGRAPHY.

Badaltja, J. 1980. Statement concerning the land. In Yule, I. (ed) My Mother the Land. Galiwinku Parish U.C.A., Elcho Island.

Beals, R. L, Hoijer, H and A. R. Beals 1977. An Introduction to Anthropology. (5th edition) Macmillan Publishing Co., New York.

Berndt, R. 1951. Kunapipi. A Study of an Australian Religious Cult.
F.W.Cheshire, Melbourne

Berndt, R. 1952. Djanggalwul. An Aboriginal Religious Cult of North-eastern Arnhem Land. Routledge and Kegan Paul, London.

Berndt, R. 1962. An Adjustment Movement in Arnhem Land. Mouton and Co, Paris.

Berndt, R.M. 1964. The Gove Dispute. In Anthropological Forum.
Vol 1 No 2 pp 258-295. Referred to in Williams (1986:18).

Berndt, R.M. 1976. Territoriality and the problem of demarcating sociocultural space. In N.Peterson (ed) Tribes and Boundaries in Australia. Australian Institute of Aboriginal Studies, Canberra.

Berndt, R.M. and C.H.Berndt. 1948. Sacred Figures of Ancestral Beings of Arnhem Land. In Oceania, Vol 18 No 4. 309 - 326.

Berndt, R.M. and C.H.Berndt . 1964/68. The World of the First Australians: An introduction to the traditional life of the Australian Aborigines. Ure Smith, Sydney.

Berndt, R.M. and C.H.Berndt. 1977. The World of the First Australians. Ure Smith, Sydney. Referred to in Williams (1986:18).

- Berndt, R.M. and C.H. Berndt 1988. The Speaking Land: Myth and Story in Aboriginal Australia. Penguin Books, Ringwood, Victoria.
- Berger, Peter L and Thomas Luckman. 1966. The Social Construction of Reality: a treatise on the sociology of knowledge. Doubleday, New York.
- Bolle, Kees W. 1987. Cosmology: an Overview. In Eliade, Mircea (ed). The Encyclopedia of Religion. Macmillan Publishing Co, New York. Vol 4 pp. 100-106.
- Borsboom, A.P. 1978. Maradjiri: A modern ritual complex in Arnhem Land, north Australia. Unpublished PhD Thesis, University of Nijmegen
- Bos, Robert. 1988. Jesus and the Dreaming: Religion and Social Change in Arnhem Land. Unpublished PhD Thesis, University of Queensland.
- Bourdieu, Pierre. 1977. Outline of a theory of practice. (translated by Richard Nice). Cambridge University Press, Cambridge.
- Buchanan, Dianne. 1991. Personal Communication.
- Caruana, Wally. (Ed). 1989. Windows on the Dreaming: Aboriginal paintings in the Australian National Gallery. Ellsyd Press Pty Ltd, Sydney.
- Chalmers, A. F. 1976 What is this thing called science: An assessment of the nature and status of science and its methods University of Queensland Press, St Lucia.
- Chaseling, Wilbur S. 1957. Yulengor: Nomads of Arnhem Land. The Epworth Press, London.

- Christie, Michael. 1988. The invasion of Aboriginal education. Paper presented at National Conference on Adult Aboriginal Learning. In, Learning My Way a special edition of Wikaru 16. pp 5-19.
- Clunies-Ross, M. and Johnny Mundrugmundrug. 1988. Goyulan The Morning Star. Australian Institute of Aboriginal Studies, Canberra.
- Davis, Stephen. 1989. Man of all Seasons. Angus and Robertson, North Ryde, N.S.W.
- Dolgin, Janet L., Kemnitzer, D.S. and David M. Schneider (eds) 1977. Symbolic Anthropology. Columbia University Press, New York.
- Douglas, Mary. 1966 Purity and Danger : an analysis of concepts of Pollution and Taboo, Routledge and Kegan Paul, London.
- Douglas, Mary. 1973. Natural Symbols: Explorations in cosmology. Barrie and Jenkins, London.
- Douglas, Mary. 1975. Implicit Meanings: essays in anthropology, Routledge and Kegan Paul, London.
- Dixon, R.M.W. 1976. Tribes Languages and other Boundaries in Northeast Queensland. In N.Peterson (ed) Tribes and Boundaries in Australia Australian Institute of Aboriginal Studies, Canberra. pp207-238.
- Dunlop, C.R, Latz, P.K. and J.R.Maconochie. 1975. A Botanical Survey of Elcho Island, July 1975. Herbaria of the Northern Territory, Alice Springs and Darwin, N.T. Australia.
- Dunlop, Ian. 1984. Afterword: On the making of "Madarrpa Funeral at Gurka'wuy". In Morphy, Howard. Journey to the Crocodile's Nest. Australian Institute of Aboriginal Studies, Canberra.

- Elkin, A.P. 1938/1970. The Australian Aborigines: How to understand them.
(4th Edition). Angus and Robertson Ltd Sydney.
- Fortes, Meyer. 1958. Introduction. In Goody, J. (ed). The Developmental Cycle
in Domestic Groups. Cambridge University Press, London.
- Flood, Josephine. 1976. Man and ecology in the highlands of southeastern
Australia: a case study. In N.Peterson (ed) Tribes and Boundaries in
Australia Australian Institute of Aboriginal Studies Canberra. pp. 30-49.
- Gondarra, Djiniyini. 1980. Statement concerning the land. In Yule, I. (ed) My
Mother the Land. Galiwinku Parish, U.C.A. Elcho Island.
- Goodenough, W. 1986. Sky World and This World: The place of Kachaw in
Micronesian Cosmology. In American Anthropologist Vol 88 (3).
- Goodman, 1964. quoted in Schlesinger 1980. Aspects of Time. Hackett
Publishing Co. Indiana.
- Goody, Jack. 1958.. The Developmental Cycle in Domestic Groups. Cambridge
University Press, London.
- Groger-Wurm, H. 1973. Australian Aboriginal Bark Paintings and their
Mythological Interpretation. Australian Institute of Aboriginal Studies,
Canberra.
- Hallowell, A, Irving. 1955. Culture and Experience. University of Pennsylvania
Press, Philadelphia.
- Heath, J. 1978. Linguistic Diffusion in Arnhem Land. Australian Institute of
Aboriginal Studies, Canberra.
- Hiatt, L.R. 1962. Local organisation among the Australian Aborigines. In
Oceania Vol 32, No 4. pp.267-286.

- Hugh-Jones, C. 1979. From the Milk River: Spatial and temporal processes in Northwest Amazonia. Cambridge University Press, Cambridge.
- Hymes, D. 1966. Language in Culture and Society : a reader in Linguistics and Anthropology Harper and Row, New York.
- Jones, W.T. 1972. World Views: Their Nature and Their Function. In Current Anthropology. Vol 13, No1. pp.79-91, 103-108.
- Jordan, Diedre F. 1984. The Social Construction of Reality: the Aboriginal problem. In The Australian Journal of Education. Vol 28, No 3. pp.274-290.
- Jordan, Diedre F. 1988. Aboriginal Identity: uses of the past, problems for the future? In Beckett, Jeremy R (ed) Past and Present. Aboriginal Studies Press. Canberra.
- Kaplan, D and R.A. Manners. 1972. Culture Theory. Prentice Hall, Englewood Cliffs N.J.
- Kearney, Michael. 1975. World View Theory and Study. In Siegel, Bernard J. , Beals, Alan R. and Stephen A Tyler (eds) Annual Review of Anthropology. Palo Alto, California. Vol 4. pp. 247-270.
- Keen, I. 1978. One Ceremony, One Song: an economy of religious knowledge among the Yolngu of North-east Arnhem Land. Unpublished PhD Thesis, The Australian National University, Canberra.
- Kolig, E. 1981. The Silent Revolution: the effects of Modernization on Australian Aboriginal Religion. Institute for the Study of Human Issues, Philadelphia.
- Kuhn, Thomas S. 1962/70. The Structure of Scientific Revolutions. University of Chicago Press, Chicago.

- Kupka, K. 1965. Dawn of Art: Painting and Sculpture of Australian Aborigines.
Angus and Robertson Ltd, Sydney.
- Leichtman, Martin. 1972. Comment on Jones, W.T. 1972. World Views: Their
Nature and Their Function. In Current Anthropology. Vol 13, No1.
pp. 97-98.
- Lévy-Bruhl, Lucien. 1910. Les Fonctions mentales dans les sociétés inférieures.
Paris, Alcan. How Natives Think. Translated by Lilian A. Clare George
Allen and Unwin, London.
- Lévy-Bruhl, Lucien. 1975. Lucien Lévy-Bruhl: The Notebooks on Primitive
Mentality. Translated by Peter Rivière. Basil Blackwell, Oxford.
- Lowe, B.M. n.d. Gupapuyŋu Grammar. Unpublished Duplicated Monograph.
- Lowe, B.M. 1975. Gupapuyŋu Alphabet and Pronunciation. Galiwin'ku Adult
Education Centre, Galiwin'ku.
- Mimica, J. 1981. Omalce: an ethnography of the Ikwaye view of the cosmos
Unpublished PhD Thesis, The Australian National University, Canberra.
- Morphy, Frances. 1983. Djapu, A Yolngu Dialect. pp 1-188. In Dixon,
R.M.W. and Barry J. Blake, Handbook of Australian Languages Volume
3. Australian National University Press, Canberra.
- Morphy, Howard. 1977. Too Many Meanings: an analysis of the artistic system
of the Yolngu of North-east Arnhem Land. Unpublished PhD Thesis, The
Australian National University, Canberra.
- Morphy, Howard. 1983. 'Now you understand' - an analysis of the way Yolngu
have used sacred knowledge to retain their autonomy. In Peterson, Nicolas
and Marcia Langton (eds). Aborigines, Land and Land Rights. Australian
Institute of Aboriginal Studies, Canberra.

- Morphy, Howard. 1984. Journey to the Crocodile's Nest. Australian Institute of Aboriginal Studies, Canberra
- Morphy, Howard. 1990. Myth, Totemism and the Creation of Clans. Oceania. 60, 1990.
- Morphy, Howard. 1991. Ancestral Connections: art and an Aboriginal system of knowledge. University of Chicago Press, Chicago.
- Munn, N. 1964. Totemic Designs and Group Continuity in Walbiri Cosmology. In Reay, M. (ed) Aborigines Now. Angus and Robertson, Sydney
- Munn, N. 1970 The transformation of Subjects into Objects in Walbiri and Pitjantjatjara Myth In R.M. Berndt, Australian Aboriginal Anthropology University of Western Australia Press, Nedlands.
- Mulvaney, D.J. 1976. 'The Chain of connection': the material evidence. In .Peterson, N. (ed) Tribes and Boundaries in Australia Australian Institute of Aboriginal Studies, Canberra.
- Myers, F.R. 1986. Pintupi Country, Pintupi Self: Sentiment, Place and Politics among Western Desert Aborigines. Australian Institute of Aboriginal Studies, Canberra.
- Nelson, Cynthia. 1972. Comment on Jones, W.T. 1972. World Views: Their Nature and Their Function. In Current Anthropology, Vol 13, No1. pp.98-102.
- Newton, Isaac 1687. The Mathematical Principles of Natural Philosophy, quoted in Park 1980.
- Ong, Walter, J. 1972. Comment on Jones, W.T. 1972. World Views: Their Nature and Their Function. In Current Anthropology, Vol 13, No1. p.102.

- Ortner, Sherry B. 1984. Theory in Anthropology in the Sixties. In Comparative Studies in Society and History, Vol 26. No 1: 126-166.
- Ortner, Sherry B. 1989. High Religion : A cultural and political history of Sherpa Buddhism. Princeton University Press. Princeton, New Jersey.
- Park, David. 1980. The Image of Eternity: Roots of Time in the Physical World. The University of Massachusetts Press, Amherst.
- Peterson, Nicolas. 1971. The Structure of Two Australian Aboriginal Ecosystems. Unpublished PhD Thesis . University of Sydney
- Peterson, N. 1972. Totemism Yesterday: Sentiment and Local Organisation among the Australian Aborigines. In Man Vol.7 No 1.
- Peterson, N. 1974. The importance of women in determining the composition of residential groups in Aboriginal Australia. In Fay Gale (ed) Woman's role in Aboriginal Australia Australian Institute of Aboriginal Studies Canberra.
- Peterson, N. 1976. The natural and cultural areas of Aboriginal Australia. In Peterson, N. (ed) Tribes and Boundaries in Australia. Australian Institute of Aboriginal Studies, Canberra.
- Peterson, N. 1976b. Mortuary Customs of Northeast Arnhem Land: an account compiled from Donald Thomson's Fieldnotes. In Memoirs of the National Museum of Victoria, Vol 37, pp. 97-108.
- Petri, H. and Petri-Odermann, G. 1970. Stability and Change: Present -day Historic Aspects Among Australian Aborigines, In Berndt, R.M. Australian Aboriginal Anthropology. University of Western Australia Press, Nedlands.

Reichel-Dolmatoff, G. 1971. Amazonian Cosmos: The Sexual and Religious Symbolism of the Tukano Indians. University of Chicago Press, Chicago.

Reid, Janice. 1983. Sorcerers and Healing Spirits: Continuity and Change in an Aboriginal Medical System. Australian National University Press, Canberra.

Robertson, Howard Percy. 1969. Cosmology. In Encyclopaedia Britannica William Burton, Chicago. Vol 6 pp. 582-587.

Ross, Joyce. pre-1977 Miscellaneous Time Words. Mimeographed sheet. Yirrkala.

Rudder, J. C. 1977. Introduction to Yolŋu Science. Galiwin'ku Adult Education Centre, Galiwin'ku, N.T.

Rudder, J. C. 1979. Classification of the Natural World Among the Yolŋu. in Ethnomedizin, Vol 5, (3/4). pp 349 - 360.

Rudder, J. C. 1980 The Song of the Turtle Rope. in Canberra Anthropology, Vol 3 (1). pp 37 - 47.

Rudder, J. C. 1983 Qualitative Thinking an examination of the classificatory systems, evaluative systems, and cognitive structures of the Yolŋu people of North-east Arnhem Land. Unpublished M.A. Thesis, The Australian National University, Canberra.

Schebeck, B. 1968a. Dialect and Social Grouping in North-east Arnhem Land. (Mss. held in Australian Institute of Aboriginal and Torres Strait Islander Studies Library, Canberra).

Schebeck, B. 1968b. Final Report of linguistic fieldwork carried out under a research grant from the AIAS from 23rd Nov. 1964 until 31st March

1967. (Mss. held in Australian Institute of Aboriginal and Torres Strait Islander Studies Library, Canberra.).
- Scheffler, Harold W. 1978. Australian Kin Classifications. Cambridge University Press, Cambridge.
- Schlesinger, George N. 1980 Aspects of Time. Hackett Pub.Co, Indiana.
- Shapiro, W. 1973. Residential Grouping in Northeast Arnhem Land. In Man. Vol 8. pp. 365-383.
- Shapiro, W. 1979. Social Organization in Aboriginal Australia. Australian National University Press, Canberra
- Shapiro, Warren. 1981. Miwuyt Marriage: The Cultural Anthropology of Affinity in Northeast Arnhem Land. Institute for the Study of Human Issues, Philadelphia.
- Shepherdson, Ella. 1981. Half a Century in Arnhem Land. Ella and Harold Shepherdson, One Tree Hill, South Australia.
- Stanner, W.E.H. 1956/1972. The Dreaming. In Lessa, W.A and E.Z. Vogt, (Eds). Reader in Comparative Religion (3rd Edn). Harper and Row, New York.
- Stanner, W.E.H. 1963. On Aboriginal Religion. Oceania Monograph No 11.
- Thomson, Donald. 1961. Marrngitmirri and Kalka - Medicineman and Sorcerer - in Arnhem Land. In Man. Vol 61. pp. 97-102.
- Thomson, Donald. 1975. The Concept of 'Marr' in Arnhem Land. In Mankind, Vol 10, No 1 pp. 1-10.
- Thomson, Donald. 1983. Donald Thomson in Arnhem Land: compiled and edited by Nicolas Peterson. Currey O'Neil. South Yarra, Victoria.

- Thornell, Harold. 1986. A Bridge over Time: living in Arnhemland with the Aborigines 1928-1944. J.M.Dent Pty Ltd, Boronia, Victoria.
- Tindale, Norman B. 1976. Some ecological bases for Australian tribal boundaries. In N.Peterson (ed) Tribes and Boundaries in Australia Australian Institute of Aboriginal Studies, Canberra.
- Tonkinson, R. 1974. The Jigalong Mob: Aboriginal Victors of the Desert Crusade. Cummings Publishing Co, Sydney.
- Turner, David H. 1974. Tradition and Transformation: a study of Aborigines in the Groote Eylandt area, northern Australia. Australian Institute of Aboriginal Studies, Canberra.
- Tyler, S.A. 1969. Cognitive Anthropology Holt Rinehart and Winston Inc, New York.
- Waddy, J. A. 1988. Classification of Plants and Animals from a Groote Eylandt Aboriginal Point of View. A.N.U.N.A.R.U. Monograph, Darwin.
- Waddy, J. A. 1989. Draft Anindilyakwa Dictionary Unpublished Manuscript.
- Wallace, A. F. C. 1968 Cognitive Theory. In International Encyclopaedia of the Social Sciences Volume 2 pp. 536-539 Crowell, Collier and Macmillan Inc, USA.
- Warner, L.W. 1937/58. A Black Civilization. Harper and Brothers, New York.
- Watanabe, J. 1983. In the World of the Sun: a Cognitive model of Mayan Cosmology. In Man (N.S.) 18, pp.710 - 728.
- Webb, T. Theodor. 1933. Tribal Organisation in Eastern Arnhem Land. In Oceania, Vol 3 No 4, pp. 406-411.

Webb, T. Theodor. 1936. The Making of a Marrngit. In Oceania, Vol 6, No 3,
pp. 336-341

Wild, Stephen A.(ed) 1986. Rom: An Aboriginal Ritual of Diplomacy.
Australian Institute of Aboriginal Studies, Canberra.

Witherspoon, G. 1977. Language and Art in the Navajo Universe. University of
Michigan Press, Michigan

Williams, D.W. (ed) 1982 The Aboriginal Australian in North Eastern Arnhem
Land. Vol IV Discovering Aboriginal Culture. The Curriculum
Development Centre, Canberra.

Williams, N.M. 1982. A Boundary is to cross: observations on Yolngu
boundaries and permission. In Williams, Nancy M and Eugene S Hunn
(eds). Resource Managers: North American Hunter-Gatherers. Westview
Press for American Association for the Advancement of Science,
Washington D.C. pp. 131-153.

Williams, N.M. 1986. The Yolngu and their Land: A System of Land Tenure
and the Fight for its Recognition. Australian Institute of Aboriginal
Studies, Canberra.

Zorc, R.D.P. 1978. Functor Analysis: a method of quantifying function words
for comparing and classifying languages, pp 510-521. In The Fifth Lacus
Forum. Hornbeam Press, Inc. Colombia, South Carolina.

Addenda

Geertz, Clifford. 1966. Person, Time and Conduct in Bali: An essay in Cultural
Analysis. Southeast Asian Studies. Yale University.

Lévi-Strauss, Claude. 1966/76. The Savage Mind. Weidenfeld and Nicolson,
London.

Lévi-Strauss, Claude. 1967. The Story of Asdiwal Translated by Nicholas Mann.
In Leach, Edmund, The Structural Study of Myth and Totemism: A.S.A.
Monographs 5. Tavistock London.

Munn, Nancy, D. 1992. The Cultural Anthropology of Time: A Critical Essay. In
Siegel, Bernard, J. Annual Review of Anthropology Volume 21.

APPENDICES.

- A. Orthography used for spelling of Yolŋu words.
- B. Myth of Yawulŋura's journey to Burralku
- C. Song of the Turtle Harpoon Rope
- D. Myth of the Turtle Harpoon Rope
- E. Story of the journey taken by the deceased in order to reach Burralku
- F. Story of Banumbirr, told by Wadaymu
- G. Summary of Warner's version of the Banumbirr Myth
- H. Story of Banumbirr, told by Galpagalpa
- I. Wuluwuma and the origin of the Morning Star

APPENDIX A.

ORTHOGRAPHY USED FOR SPELLING OF YOLŊU WORDS.

The orthography used throughout this thesis for spelling is that developed by Beulah Lowe (1975). It has been adopted by the Yolŋu communities for spelling all the Yolŋu languages and dialects. I have used it throughout this thesis as my best attempt to represent the Yolŋu words in a way that enables them to be pronounced with as much accuracy as possible. I describe the sounds for simplicity in the following tables as they are taught to the non-Yolŋu members of the Northeast Arnhem Land communities who attempt to use some of the Yolŋu language in an effort to communicate more effectively with Yolŋu people

Consonants.

	bilabial	alveo-dental	interdental	alveolar	retroflex	velar	glottal
nasal	m	ny	nh	n	<u>n</u>	ŋ	
voiced	b	dj	dh	d	d	g	
voiceless	p	tj	th	t	t	k	'

Vowels.

short		long	
a	as in "ado"	ä	as in "father"
i	as in "sit"	e	as in "see"
u	as in "put"	o	as in "poor"

Liquids.

alveolar	l	
retroflex	<u>l</u>	r
trill		rr
continuants	w	y

APPENDIX B.

MYTH OF YAWULŅURA'S JOURNEY TO BURRALKU.

(as narrated by Mathaman Marika at Yirrkala in 1967).

This is the story of YawulŅura, an old man who went to Burralku (the place of the dead). He found *mokuys* there and returned to Caledon Bay, on this side. He was Ņaymil like Wadaymu and LarrtjanŅa.

The *mokuys* (spirit beings / deceased humans) lit a fire at Burralku and the *gunguyu* (ashes) came to Caledon Bay. YawulŅura thought, "What's this?" when he saw it falling at Caledon Bay on the beach. He thought, "Where is this from?", then he called his wives and told them that he'd found dirt (ashes) from fire..

"You get *Ņathu* (cycad), and I'll make rope. Your *djäma* (work) *räkay* (swamp rush corms) and *Ņathu* and *dhaniya* (containers made from paper bark)."

He made rope, very long, 2 or 3 miles. When it was all finished there were three *likirri* (coils). Bark canoe ready. Took two women and left one on the outside island, let out rope. Other women to stay.

In the morning he took the two women and the food. They got to an island called Djurrwanbuy and camped there for one or two days. There he found a rock for an anchor, and he waited to see where the morning star rose. He saw it, and marked that place. He thought, "Maybe there's a *wäŅa* (camp or place) there."

In the morning he set off on his own with his food and water. He paddled all day till sunset. He anchored there and slept. He woke up and checked the morning star, then picked up his anchor and went on. The sun came out and he saw that sun and went on always paddling. Might be three days, might be four, might be five days like that, paddling all day, then put down the anchor and sleep at night.

Can't see that place *galki* (close to) Burralku. Might be three, four, five days, and he look long *wiripu* (different / another) island. This one named Gayawukawurru, close to Burralku. *Dharrwa garriwa* (many turtles / turtle eggs) there and *dharrwa ganguri* (many yams) there. (Might not be true). He took a little stick and stuck it in the ground. This chased out a *mokuy* (a spirit being), and it chased him back to the canoe. *Dhuwala nyäl'yun dhäwu*. (This is a lying story). "I thought maybe turtle eggs, but I'll go now."

One more day and he came to a big place with a long beach. (It was Burralku). It was a seagull place and there were many there. *Catchim wäña* (arrived at the place). There were many porpoises there. He left the canoe, saw seagulls and walked on. He saw footprints then went back and brought the canoe up close. He saw many footprints *mokuywu* (belonging to the dead ones). Then he saw and heard *birrkpirrk* (the masked plover) and thought "Maybe someone's coming from somewhere and they've (the birds) heard them."

He saw yolŋu coming . Their names were Mälumbu and Yambuyambu. They were not happy for him. "Where's water?" he asked them. "Only rubbish," they replied. "*Wanha wäña?* (Where's the camp?)" he asked. "Long way, big path." they replied. *Nyäl'yun dhäwu*. (This is / was a lie).

Then he saw *gudurrku* (brolga/s) and he heard the sound of a *bungul* (a ceremony with dancing and singing), so he painted himself with *gapan* (white clay) and took a different spear thrower with him (*guymala*). Wulambu / garrarrambu is the Gälpu [clan] name [for the spear thrower]. The birds looking at him thought Yawulŋura was a *mokuy yuta*. (a newly dead person).

Yawulŋura danced and sang *yindi* (big). The mokuys saw and talked about his dancing. Some called out for his name. "Yawulŋura," he said. "Are you a *mokuy?* (dead person)," they asked. "No! I'm alive." He danced the *bunguls* (dances),

banumbirr (morning star), *gudurrku* (brolga) and *birrkpirrk* (plover), then he said, "I'm going back to see my children, and I'll come back.

He went back to the canoe, got *djindjapana* (porpoise meat), and *galun* (a yam, *Cayratia trifolia*). Then he went back to the island and got the two women. They were happy for him.

In morning pickem up and go catchim up mainland and told them *yindi dhäwu* (the big story). He stayed for a little bit long time then went to look for turtle eggs. He found some then went and camped in the shade of a tree. Made big fire - cookim turtle egg - pinish -ate em, *dharrwa* (many), the lot - his stomach swell up - him get very sick and died.

Finished, and put im in ground, and his spirit went to Burralku like he promised.

APPENDIX C.

SONG OF THE TURTLE HARPOON ROPE.

(As recorded by Djorripum).

1. a ...a ...

Introductory humming (non-verbalised singing)
[All the materials are there ready to start].

2. *rawu ḡorranan budurrutjun mokuywal waḡarr waḡarrwal*
 rope lay there, twisting with the creative with creative
 dead one ancestor ancestor

The rope is lying there, getting longer as they work together, twisting from hand to hand in harmony, as did that dead one, the one who created rope at the beginning.

3. *märr-weyinmirr ḡorranan Mukarrwal Golinygal,*
 fairly long time lay there with Mukarr with Goliny

He travelled for a relatively long time [along the Wessel Islands] then stopped and rested; that's the way it was with Mukarr. We call him Goliny also.

4. *mokuyyu marrtji ḡaraka ḡupan waḡarr waḡarryu*
 dead one went bones chased creative creative
 did it [followed up] ancestor ancestor did

Those dead ones went on, following up the sacred sites along the Wessel Islands [with cross reference to peeling the fibre and piling up the bones (sticks from which the bark has been peeled), making the turtle rope]. The creator of rope did it.

5. *Rawu ḡorranan, dilimarra bon-rirramulmirr*
 rope lay, big rope got wet

The rope was lying there quietly in the canoe. [A turtle is harpooned]. That strong rope curls out into the water getting wet as it follows the turtle through the water.

6. *Rawu ḡorranan bon-djabatjmirr*

Rope lay skilful hunter

The rope lay quietly again in the bottom of the canoe. Both the rope and *mukarr* have been skilful in their pursuit.

7. *Rawu ḡorranan bon-djekurrmirr*

Rope lay rain clouds standing

The rope lies quietly again on the shore. [The hunt and the eating are completed]. Dark tropical rain clouds are standing over a wall of rain on the horizon.

8. *Mawukthun*

lying still.

Stillness, completion, perfection, peace.

APPENDIX D.

MYTH OF THE TURTLE HARPOON ROPE.

(As told by Djorrpum).

Section 1. At the beginning of things, the ancestral beings made rope. Mukarr is the name of those beings. They are also called Goliny; that is another name for them. Mukarr went walking through the open forest and through the jungles collecting rope fibre. They cut branches of the kurrajong trees, collecting them together, piling them into a heap, collecting enough to make a long rope. Those kurrajong trees had been growing there in all the country, and Mukarr collected the fibre and brought it together in one place. Those Mukarr worked together, collecting the Kurrajong branches and then peeling the fibrous bark from them.

Section 2. Those Mukarr sat facing each other with the first strands of the fibres tied to an upright forked stick. They sat facing each other with three strands, passing them from hand to hand, twisting each strand as they passed it, causing each to bind closely to the others, twisting into a single strong rope. They twisted and passed adding new strands as the rope grew. It grew and grew, forming a coil on the other side of the forked stick.

Section 3. Twisting and turning it grew. Twisting and turning as the fibre was used in its making, the rope grew. They worked together, peeling, peeling, laying the bark fibres out to dry, throwing the wood to one side.

Section 4. The pile of sticks grew and grew. Finally all the fibre is used. That rope is complete now. It lies waiting, ready for action, ready for the hunt, ready to go out and get turtle. Mukarr binds it to a harpoon made from the wood of the stringy bark tree. He binds it on with strong fibres. To the other end of the rope he ties a big float of wuduku.

Section 5. He carries it to the canoe, completed, ready to go. The tide is ready now, the sea is still, the rope lies quietly in the bow of the canoe. Mukarr sets out on his journey, paddling, paddling, paddling. The rope lies waiting. Mukarr stands in the bow of the canoe watching, looking for turtle. The rope lies quietly at his feet. "there is turtle, over there." They paddle quietly closer. Mukarr stands motionless, harpoon poised, steady ... go The rope coils out into the water, at one with the harpoon tip. It grips the turtle firmly and strongly, feeling the wetness as the water bubbles past. This is joyous excitement. This is the purpose for existence. The buoyant float on the other end of the rope is holding back, dragging on the turtle, tiring it, overcoming it, forcing it to come to the surface for breath. Mukarr is following, watching the float. The turtle dives with insufficient breath; the rope continues to hold him. Weakened, the turtle lies gasping on the surface. Mukarr is there pulling in the rope. He has the turtle. Mukarr lifts it into the canoe. He is a skillful hunter.

Section 6. Those Mukarr are returning now, back to the beach, quietly paddling but exultant, a turtle is in the canoe. That which he has created, the rope, is truly effective. The rope lies there again in the canoe, quietly resting. It has fulfilled its purpose admirably, with skill and strength. That rope is perfection.

Section 7. They have returned now, the turtle is cooked, the hunt is over. Relaxing. The rope lies dry, coiled up on the sand. The Mukarr are lying there beside the rope - satisfied - complete. The sun has gone below the horizon on its journey back to the east. The dark tropical rain clouds stand pink-tinged and glowing in the sky. There is a wall of rain standing below them on the horizon. All is completed, the day, the hunt, the task.

Section 8. The very purpose of the creation is fulfilled. It is done.

APPENDIX E.

STORY OF THE JOURNEY TAKEN BY THE DECEASED IN ORDER TO REACH BURRALKU.

(As told by Djiniyini)

This is really the journey taken by the Birrimbirr of a person after he dies, but there are some people who refer to it by the term mokuy, because that is the name we give to the corpse of a dead person. The final rituals have to be right to give the spirit the correct directions for his journey.

At first when a person dies and just after the burial the spirit is still around the place where the death occurred. For two or three nights the relatives will try/test to see if it will indicate its presence in some way. If they do not hear from it they know it has taken its journey, that it has jumped in the canoe and paddled to Burralku.

On the journey there is a place where the spirit meets opposition. Mostly this opposition comes from *winyiwinyi* (small bats), which try to misdirect the birrimbirr onto the wrong path. If it is not wise it will be misdirected and return to the place where it died. If it is wise it knows how to protect itself and gets to another place where there is a water hole.

At this second place it meets different people who are singing. The songs that these people are singing are the echo of the songs that were sung at his funeral. He waits for one particular song, that of the morning star. When he hears them singing morning star and he also sees it, he then paddles off following the star to Burralku.

On this final stage of the journey he sees the things that were sung for him at his funeral. He sees things like *birrkpirrk*, *gudidi*, *baripari* (three bird species)

and *mokuy natha* (food eaten by spirit beings) and is happy because he is close to home.

Upon arrival at Burralku he is tested by two *mokuy* (dead ones) who check to see that he has had his nose pierced, and they look at his teeth because one of them should be missing. (This was a Macassan tradition). If he passes they say to him, "Go and drink the clean water prepared for you". If however he fails to pass he is told to go and drink *yätjkurru* (bad/rotten) water. and then if he has not passed he is sent back and becomes a *wakinju mokuy* (an uncivilised spirit being) and stays around the earth trying to steal the spirits of other people when they die. These uncivilised spirits are also known by the term *Gurrka-gapumi* (Literally penis having water).

APPENDIX F.

STORY OF BANUMBIRR

as told by Wadaymu.

Yo dhaŋum dhäwu, yurru ŋarra dhu lakaramany

Yes this (is) the story but I will tell (it)

Djambarrpuyŋu dhäruk bili wäwaw easikum.

(in) Djambarrpuyŋu language because for brother make easy

Yo, ŋurukuwuy wäŋapuy Gundalmirriwuy. Gundalmirri

Yes about that place Gundalmirri. (At) Gundalmirri

gan djäma mokuyyu, yäkuny ŋayi Goŋ-bilma,

was working dead one did, name he Hand-clapstick

(always singing)

ga wiripu ŋayi yäku, Yawulŋura, ga miyalktja yäku

and other he name Yawulŋura, and woman's name

Mälumbu. Njunhili ŋayi gan djämany ŋunhili Gundalmirri.

Mälumbu. There he was working at that place Gundalmirri

Ŋamaŋamayurruna ŋayi Baŋumbirr, barkparkthurruna

Made he morning star sang

ŋayi, gan barkparkthurr yakurr yätjin Baŋumbirru,

he, was (that) singing sleep spoiled (for) Baŋumbirr

ga ŋayiny gan (nhawuny), Mälumbuny gan ŋäthin

and she was (what was it), Mälumbu was crying

Banumbirrwu bayiku. Yakurr yätjin ηayi
 for Banumbirr for that one. Sleep spoiled she

gan ηäthin, Banumbirrwu ηamaηamayunaraw.
 was crying for Banumbirr for making.

1. Yes this is the story, but I will tell it in Djambarrpuyŋu language because it will be easier for brother to understand it. Yes the story is about that place Gundalmirri. At Gundalmirri there was working that spirit being named Goŋbilma ("Hand-clapstick" or "Always Singing"). His other name is Yawulŋura, and woman's (or wife's) name is Mälumbu. He was working at that place Gundalmirri making the morning star. He was singing, and that singing for Banumbirr spoiled his wife's sleep and she (Mälumbu), was crying because of Banumbirr. Her sleep was spoiled and she was crying for Banumbirr, for its making.

Manymak. Bulu ηayi lirtji wäthurr. Lirtji ηayi
 All right. Again he cried out sounds while holding it he
 and dancing and shaking his arms.

ŋurrkaŋal, Dhanbulyu. Yän ηayi ganydjarmirriyaŋal
 threw out, Dhanbul did Just he made powerful
 (Djapu name for Mokuŋ)

Banumbirrnha, ŋaraka maypurumburr, ŋarakamirr
 Banumbirr, bone/core put on everything bone/core - having
 (string, feathers and paint),

gan ŋorran, ŋarakamirr yilirrwamirr,
 was there bone/core-having put on everything,

maypurumburrimirr. Nunhi walal, bala ηayi yidaki
 put on everything. There they then he didgeridoo

ŋurrkaŋal bala ηayi ŋurrkaŋal nha, yäkuŋur wäŋaŋur
 played then he played name-at place-at

Gundalmirrigur, Banumbirr.

Gundalmirrigur, Banumbirr.

2. All right. Again he cried out sounds while holding it and dancing and shaking his arms. Dhanbul did (Djapu name for that Spirit being). He made Banumbirr powerful, put everything on the bone/core (string, feathers and paint) when they were all there on it, he played the didgeridoo. He played at the place named Gundalmirrigur, (He played the tune) Banumbirr.

Manymak, bejuru ηayi, wandin, ηayi ηunhi, gapu

All right, after that it, went quickly he that, water

ηapar, Gundalmirrigur, ga ηunhal bayma gulyun

crossed, at Gundalmirri, and back there stopped

ηayi nhawimirriguryi Burralku. Burralku begur

he at what place was it Burralku. Burralku from there

ηunhiyi. Nunhal ηayi dhawal-nhāgal. Nhāgal

thatplace. There he place-saw Looked at

ηayi wāga dhawal, Mayayikurr̄u, Mayayilka,

he place place, Mayayikurr, Mayayilka,
(alternative names for Burralku)

dhuwal Bin̄gurr̄pingurr.

this is Bin̄gurr̄pingurr Island.

3. All right. After that it went quickly and crossed the water there at Gundalmirri. and then it stopped at Burralku. From Burralku he looked and saw the place named Mayayikurr and Mayayilka. That is Bin̄gurr̄pingurr Island

Manymak, beguryi ηayi dhuduwutthurr, yurr ηayi

All right after that he came down, but he

gan gapukurr marr̄tinany. Ga walman ηayi dhuwal,

was across water travelling. And came out he here

nhawuḡur, Wäkurra. Wäkurra ḡayi gorrugal,
 where was it, Wäkurra Island. Wäkurra he went up above

nhäḡal ḡayi dhawal Mayayikurrḡu. Ga beḡur
 saw he place Mayayikurr. And from there
 (Djambarrpuyḡu place)

ḡayi lupthurr, ga walman ḡunha nhawuḡur
 he went through and came out there at where was it
 water

Burralku ḡunhi galki dapmaram ga Nurruyurrḡurrwuyḡuy,
 Burralku there close Names of islands near Matamata

ga Mayayikurrwuyḡuy. Nunhili ḡayi walman.
 and . There he came out.

Näkul walal gan bilma nhanukuḡ mokuywuḡ,
 Hearing they were clapsticks from him from that mokuy

ḡunha nhawuḡur Mayayikurr, mokuywuḡ
 There where was it Mayayikurr, from the mokuy

Djambarrpuyḡuwuḡ, waltjanguḡ Wulwulwuḡ
 Djambarrpuyḡu (from), from bottom Djapu.

Nunhilin mokuy burr'yurr gan Läy-marrmarr, Läy-marr ga
 There the mokuy dancing was North wind, (Djambarrpuyḡu
 group),

Ga ḡunhili ḡayi gorrugal. ga ḡunhili walalnydja
 And there he climbed up. and at that place they

ḡulaḡurundydja nhäḡal, djulkthuna. Nayi marrḡjin
 from there saw, go past. He went

djulkthurra. *Gulyundja* *ga* *ṅunhili* *giritjin,*
 past stopped and there danced

Mawukawnha, *bulpulwun,* *banbalarrwun,* *ṅunhiliny,*
 the string Mawuka, feathered, feathered, there

ga *nhawukun,* *Baladay'wun.* *Nunhili* *walala gan*
 and for what for that jungle There they were
 yam baladay.

giritjin, *Mayayikurrnydja.* *Nayi* *Naymilnydja*
 dancing, at Mayayikurr. He Naymil

Banumbirr *djulkthurra.* *Balan* *Wäkurragur,*
Banumbirr went past. Towards Wäkurra,

ga *dhudutthurr* *gapu* *ṅupar* *ga* *walman*
 and sank down water crossed and came out
 went under

dhiyalnha *Burralkuya.* *Dhuwanaya* *dhuwana*
 here at Burralku Here at here at

Burralku, *Galiwinkun* *dhuwanaya* *ṅurrugur,* *Djarraya*
Burralku, Galiwin'ku here at point at, Djarraya

namba 2ṅur, *dhiyalnha* *dhawatthurr.* *Dhipugur*
 the lesser one, there at came out. From there

ṅayi *gan* *dhawal* *nhäṅal,* *nhäṅal* *dhuwalnha.*
 he was place looking at, looked at here

Dhuwalnha *ṅarrakun* *wäṅa, ga* *Ruypuny,* *Milwinditja,*
 This my place, and Ruypu, Milwinditja,

Gawuypu, Ruypu, gorrum ga, Djoniwuy." Bitjarrŋayi
 Gawuypu, Ruypu, up in is, at Djoniwuy." Thus he
gan ŋunhi ŋayipi ŋunhi waŋarr, Banumbirr waŋan.
 was there he himself that spirit being, Banumbirr spoke.

4. All right. After that he came down, and was travelling through / across the water, and came out here at Wäkurra Island. At Wäkurra he went up above and saw that place called Mayayikurr, (a Djambarrpuyŋu place) and from there he went through the water and came out at Burralku which is close to the islands Nurruyurrjturrwuyŋuy and Mayayikurrwuyŋuy near Matamata. There he came out at Mayayikurr and they heard the spirit being's clapsticks from that spirit being from Djambarrpuyŋu and Waltjanguŋ Wulwulwuy (from the Bottom Djapu clan). There that spirit being was dancing north wind for the Djambarrpuyŋu people, and there he went up and they saw him go past. He went past and then stopped and danced the feathered string "Mawuka" (which is a yam) and (that other jungle yam called) "Baladay". There they were dancing at Mayayikurr. He, that Njaimil clan Banumbirr went past towards Wäkurra. It went down and went under the water and crossed over the water and came out here at Burralku, here at this Burralku on Galiwin'ku, here at the point called Djarraya number two. It came out here. From there he looked to here. "This is my place, Ruypu, (also called) Milwinditja and Gawuypu." He went up at Djoniwuy, that's what he said that spirit being named Banumbirr

Nunhaŋurnydja ŋayi dhudutthurr
 There at he sank downthrough and went under

ga walman dhiyanhaya Djoninur, ya dhuwal
 and came out here at Djoni, you see

bukunur Djoniwuy. Dhiyalnha ŋayi gorruŋal
 hill at Djoni. Here at he was up

bala nhäŋal ŋunhal wäŋa dhawal runu gay. Runu
 then saw that place place island eh. Island

dhuwal yutjuwala gorrum'kurrum ga, ga bala
 here small be up are and then

6. All right, from here at Gawuypu, Ruypu, (Galiwin'ku names). He stopped here. At Ruypu he coloured the bones/core/earth with ratjpa (haematite iron oxide pigment), Milwinditj Gawuypu (Galiwin'ku alternative names). Then he thus (spoke) "Yes you and I here will stay, Gunuwaṅa (Murrūṅun clan name) and Buḷukmana, Dar'miny, Guwarr'miny, (Ṇaymil clan names) Gondarra (Golumala clan surname), is separate, but those two only are first, Buḷukmana, and this place Gunuwaṅa. First they two, they two are leaders for here, Gunuwaṅa (Murrūṅun clan) and Buḷukmana. (Dhudi Ṇaymil clan) There he coloured this place with ratjpa (haematite iron oxide pigment) Gawuypu, Ruypu, Milwinditj, Dhaltha, Gundalmirri, Djirritjirri, Djomaṅa. [Likān terms for Nongurr (Gondarra and Ṇaymil)]. There from Gundalmirri (close to Gurrumurru) and here at Gundalmirri (at Elcho).

Manymak. Dhipuṅuru ṅayi nhāṅal ṅunha ṅayi

All right. From here he looked at there he

Murrūṅa' nhāṅal wāṅa. Lupthurr gapu

Murrūṅa looked at place. Passed through water

ṅupar ṅunha Mirikindi, Maṅaymaṅay,

crossed there Mirikindi, Maṅaymaṅay,
(names for water)

Dhawunuwunu. War'war'yurr ṅayi waythurr

Dhawunuwunu. Moving he swam

bala ga ṅunhaliyi Murrūṅa. Wäladaṅur ga

to there and there at Murrūṅa. Wäladaṅur and
(place near Milingimbi)

beṅur Wäladaṅur ga Murrūṅa. Ga ṅunhilin

from Wäladaṅur and Murrūṅa. And there

ṅayi gan gorruṅal. Nhāṅal ṅayi bala

he was going up. Looked at he towards

ṅunha Luṅurr. Ṇangalala yäku yindim, ga

there Luṅurr. Ṇangalala name big (area), and

Lujurr ɲayi ɲunhi yindiny wäŋa yuwalktja

Lujurr it that big place truly

wal'ŋu. Lujurr, yurr Marrawurrpa ɲunhi Marrnhala

truly. Lujurr, but Marrawurrpa there Marrnhala
(big area) (Close to Rramingining)

ɲunhiyiny wäŋa Gawuypu ɲunhayiny. Manymak.

that place Gawuypu there. All right
(iron oxide like at Galiwin'ku)

7. All right. From here he looked at that Murrunga place. He passed through the water, crossing the water called Mirikindi, Maŋaymaŋay, Dhawunuwunu (names for water). He swam to that place there at Murrunga. He was at Wäladanur (place near Milingimbi) and then from Wäladanur to Murrunga. There he went up. He looked towards Lujurr, that's the name for the big area at Nŋangalala, Lujurr is that big place truly. It's truly Lujurr but Marrawurrpa is the big area there at Marrnhala (Close to Rramingining). That place is Gawuypu (iron oxide like at Galiwin'ku) there. All right

Bala bitjarr ɲayi · wana djany'tjunmaraŋal

To there thus he arms, went in different directions

Gawuypuy, Marrnhalay, ga ɲurukun gorrunharaw

Gawuypuy, Marrnhalay and for that went up for

Lujurrwuyŋu, wanɲanydja wana. Ga dhunupa'ɲuny

Lujurrwuy, one arm. And right side from

ɲayi wana djany'tjunmaraŋal, ga balan.

he arm went in different direction, and to there.

Dhawal lakaraŋal ga ɲunha, Marrawurrpa,

Place told/spoke/named and there, Marrawurrpa,
(Burarra marawurrpa people)

Gunini, Benydjura, Marrawalawa. Nunhiyin ɲayi

Gunini, Benydjura, Marrawalawa. There he

dhawal lakaraŋal. *Banumbirrwuy* *dhaŋum* *dhäwu,*
place told/spoke/named Concerning Banumbirr this story

Banumbirrwuy. *Dhuwaliyiny nhanu* *Banumbirrwu* *dhäwuny.*
Concerning Banumbirr. That's his Banumbirr's story.

8. From here his arms, went in different directions Gawuypuy, Marnhalay and he went up and one arm went to Luŋurrwuy. His arm from right side went in a different direction. It named the place Marrawurrpa, (belonging to Burarra-marawurrpa people) also named Gunini, Benydjura, Marrawalwa. This is the story concerning Banumbirr. It concerns Banumbirr. That's Banumbirr's story.

Manymak, *yurr,* *Ŋaymil* *yän* *ŋunhi*
All right, but Ŋaymil just that

Banumbirr *marrtjin.* *Ga* *gulyurnydja* *ŋayi*
Banumbirr went. And stopped he

ŋunhalnha *Gunini,* *Benydjura,* *Marrawalpa,* *Marrawala*
there Gunini, Benydjura, Marrawalpa, Marrawala

ŋunhal. *Ŋunhalnha* *ŋayi* *gulyurnydja* *Ŋaymil* *ga*
there. There he stopped Ŋaymil and

Murruŋun, Ŋaymil *ga* *Murruŋun* *ŋunhiyiny.* *Murruŋun*
Murruŋun, Ŋaymil and Murruŋun that. Murruŋun

Mälarra, *Murruŋun* *Gunbirri.* *Dhuwandja* *Banumbirnydja*
Mälarra, Murruŋun Gunbirri This Banumbirnydja

gulyurr, *Murruŋun* *Gunbirri,* *Murruŋun* *Mälarra,*
stopped, Murruŋun Gunbirri Murruŋun Mälarra,

Ŋaymil, ga beŋur *Ŋaymilgur.* *Ga* *dhuwaliyin* *ŋayi*
Ŋaymil, and from that Ŋaymil (place). And that (one) he

Gulmannha gulyurrnydja, Gunini, Benydjura,
Gulmannha stopped, Gunini, Benydjura,

Marrawurrpa. Nunhan dhärra ga gungan. Gungan
Marrawurrpa. There standing is pandanus. Pandanus

maliny ga nunha dhärran. Nunhiliyin (nhawuny)
image is there standing. That's (what's it)

nambany nhanu dhawar'yurr.
the whole of his (details) completed.

9. All right, but it was just the Naymil Banumbirr that went. And he stopped there at Gunini, Benydjura, Marrawalpa, Marrawala there. There he stopped Naymil and Murrugun, Naymil and Murrugun. That's Murrugun Mälarra, and Murrugun Gunbirri. This Banumbirnydja stopped Murrugun Mälarra, and Murrugun Gunbirri, Naymil, and from that Naymil (place). And that (one) he Gulmannha stopped, Gunini, Benydjura, Marrawurrpa. There is a pandanus tree standing there. Its pandanus image (of Banumbir) there. (at Marrawurrpa). That's the whole of his (details) completed.

APPENDIX G.

SUMMARY OF WARNER'S VERSION OF THE BANUMBIRR MYTH.

A Gälpu clansman (his Kalpu) named Yawuljura (his Ya-ol-ngur-a) has a leaf brought to him from the East from beyond the sea. He goes on a journey of seven days by canoe to find that country, at the end of the third day he reaches an island where he is able to re-provision with bird's eggs, then on the fourth day after that finally reaches Burralku (his Pu-rel-ko), being guided in the last part of the journey by the light of the morning star.

At Burralku he meets the mokuy (his mokois = ghosts), sings for them and they dance. He is given "three of the best" of the young ghost women and then says, "I want to see your morning star". This is owned and controlled by an old woman named Mälumbu (his Mar-lum-bu), and kept in her basket. He tries all night using persuasion and she cries, knowing she will have to show him because he sings "magical songs" including the singing of her own name. At this point she takes it out of her basket and is quoted as saying (p526) "I'll show you this one. It comes from this Island of Perelko. Do you see this big part of it? They are sea-gull feathers. And this other part is the jungle yam." To which he replies, "It is just the same as the one we dance with in our Barnumbir ceremony. Mine, too, is made of sea-gull feathers and of the yam." He holds it and then gives it back and sings the Banumbirr song, and the old woman turns it loose. It flies up, still attached to its string, alights first on a tall pandanus tree, then flies when Yawuljura sings Melville Island it flies there Melville Island

The star's journey (Warner declares it to be "a woman because her mistress is a woman") then includes "Ka-ral-tja" in the English company Islands, to the mainland where the "Naladaer" people live near Buckingham Bay and then to Elcho Island where she finds "Marungun" people. At this point it starts to become

daylight and the old woman pulls her back on the string and putting it in her basket, curls around it and goes to sleep.

Yawulpura decides to go and get his family and bring them to Burralku. There is an exchange of gifts between him and the head man of the ghosts. They provision his canoe and he returns the way he came. He is welcomed home by his children and wives, and feeds them with the provisions he has brought with him.

That night he breaks his back as he copulates with one of his wives, his backbone having been weakened because the ghost wives had stolen his spirit. His human wives mourn his death and his soul returns "to the Perelko ghost women who waited for him and saw his return".

APPENDIX H.

STORY OF BANUMBIRR.

as told by Galpagalpa 1.

Yo Banumbirnydja. Banumbirr mala, bulpul ŋunhi,
 Yes Banumbirr Banumbirr group feathers there
ga walalaŋ. Ga ŋarakany, ŋarakany yindi ŋunhi,
 and for them. And the core, the core big there
ga Wiliw, Golumalaw bāpurruy. Yo, Wili (nhawi)
 and for Wili for Golumala clan. Yes Wili (what was it)
ŋayi bāpurru djambi Guyuwu. Guyuwu ŋayi, ga
 he clan change he, and
Gondarra Yarrayarmirri ŋayi. Wili bungawa ŋayi
 Gondarra string having he. Wili boss he
ŋarakaw, ga wiripuny, ga wiripuny ŋunhi
 for the core, and others, and others there
bulpulɗja, ga wiripunyi just manikay, ga
 feathers, and others just songs, and
bungawany ga Wili yan, ŋayipi yan
 boss and Wili just, he himself just
ŋarakaw, ga bulpulɗja ŋunhi dhärra yan yolgu.
 for the core, and feathers that stand just (the other) people.

1. Yes Banumbirr. (Concerning) the Banumbirr group (of clans) the feathers are there for those others. And the core, the big core there is for Wili (the leader) for the Golumala clan. Yes Wili he changed clan, and (now) the Gondarra (family) are having the string. Wili is the boss for the core, and (some) others there (are represented by) the feathers, and others just (have) songs, and the boss is Wili, just he himself (is the boss) for the core, and feathers there stand (for the other) people.

Yo, bungul yan giritjirr Banumbirrur bungul
Yes ceremony just dancing at the Banumbirr ceremony

warrpam'thu, wo mak Murrugun yolju bapurru,
everyone does, or maybe Murrugun people clan,

ga Gunbirrdji bapurru ga Djambarrpuyngu bapurru,
and Gunbirrdji clan and Djambarrpuyngu clan,

bulpul, wangany bulpul, (nhawuku) ya
feathers, alone feathers, (what was it for) yes

warrakangu bulpul nunhi nayi ga djäma
bird's feathers that/there it is making

ga wänalil malañulil. Yo nunhi, walal
and to the place every. Yes there, they

ga giritjirr nuriki Guyulungu. Guyulun nayi yäkuny
are dancing for that Guyulun. Guyulun it (is) name

naraka ga Banumbirnydja nayi yäku ga bulpul.
(of the) core and Banumbirr it name and feathers

Gunbirrdji ga Mälarra, ga Dhäpitjin

Gunbirrdji and Mälarra, and Dhäpitjin

ḡunhi, ga yol wiripuny ḡunha Murrugun,

there, and who other there Murrugun

bala ḡunha bala Gätji'way, Ya ḡunha,

then (over) there Gätji'way, Yes there

ga yol wiripun, ḡunha bala, ḡunha bala

and who other, (over) there, (over) there

nhawi, nhawi, yolḡu Balḡarra, Balḡarra,

(what was it) people Balḡarra, Balḡarra,

ḡunha bala barrku, ḡunhal ga dhawar'yun

(over) there far, there and finished

ga Balḡarrwal, dhuwal bulpuldja, wäḡalil malaḡulil.

and with Balḡarra, this feathers, to places group.

Ya dhuwal lakaraḡal ḡunhi walal ḡuli

Yes here spoke that they habitually

ga giritjirr, ga bungawany ḡunhi ḡayipi

are dancing, and boss that he himself

dhuwal bili Wili. Nhanḡu bokmar mokuyyu

this onle Wili. For him created spirit did

nhawiyu ḡunhal wäḡaḡur Gundalmirri ḡayi balanya.

(what was it) there at the place Gundalmirri it thus

3. Separately (related) to the feathers are Balamumu, and Roy('s) group, and Djambarrpuyṅu, and Murrūṅun, and Gunbirrdji and Mälarra, and Dhäpitjin there, and who else there Murrūṅun then (over) there Gätji'way, Yes there and who else, (those) people (over) there, Balṅarra. Balṅarra, are far, (over) there and with Balṅarra that's the lot. of its feathers, (relating) to places. Yes here (I've) told that they dance, and boss is Wili.himself here The *mokuy* (dead one) created it for him alone there at the place Gundalmirri. That's what it did.

Question: *Yol ṅayi?*

Who he?

Answer: *ṅayi Wili.*

He Wili

Question: *Ga yol ṅunhi mokuy? (Pause) Nhä mokuy?*

And who that dead one? (Pause) What spirit?

Answer: *Mokuy ṅunhi wiripu, (that devil), ṅunha bala,*
spirit that other, (that devil), (over) there,

be bala, ṅunha retjaṅur ga nhina.

far to there, there in the jungle is sitting (staying).

He's spirit nhakun yo balanya,

He's spirit like yes thus

wuṅili ṅayi, mali. Nhanṅu djäma ṅayi gan

shadow he, image. His working it is

Baṅumbirrdja ṅunhi. Bitjarr dhuwal

Baṅumbirr there. Thus this/here

Djambarrpuyŋu *dhuwal*, *Murrŋun*, *dhuwal*
for Djambarrpuyŋu this/here, for Murrŋun, this/here

Gunbirrdji *ga* *dhuwal*, *nhawiku*, *Balamumu*,
for Gunbirrdji and this/here, (what was it) for Balamumu,

(*bitjarr* *ŋayi* *gan* *waŋan* *ŋunhi* *mokuy*).
(thus it was speaking that spirit).

Guluthumbirr *yäku* *mokuy*, *Guluthumbirr*, *yäku*
Guluthumbirr name spirit, Guluthumbirr, name

ŋayi *mokuy* *Guluthumbirr*. *Nunha*, *ŋunhi*. *Yo*
it spirit Guluthumbirr. That, there. Yes

nhina *ŋayi* *ga*, *ŋunha* *nhawinur* *Gundalmirri*.
staying it is, there (at where) Gundalmirri

Yindi *wäŋa* *Gundalmirri*, *ga* *retja* *yindi* *bulu*,
Big place Gundalmirri, and jungle big more,

bulku *ŋunhi* *dhaŋaŋ* *mokuy* *bitjan* *ga* *dance*,
there full spirit thus and dancing,

giritjirr *ga* *giritjirr* *ga* *bitjan* *Banumbirru*
dancing and dancing and thus for Banumbirr

ŋurikiyi. *Ya* *ga* *bulu* *dharryunmirr*, *bitjan*,
for that (one). Yes and more crying, thus

bingalyu, *ŋayi* *mokuy*, *ŋunhi*, *nhawi* *ŋayi* *wuŋuli*,
head stabbing, it spirit, there (what's it) it shadow,
(with sticks)

mokuy. Ga djäma ñayi ga, ñuliguryi ñayi
spirit. And working it and, after that it

ga marrtji ñunhiyi ñuliguryi milkarrigur,
is coming there from that from crying

ga ñunhi ñayi Banumbirr djäma, bukmakku
and there he Banumbirr made, for everyone

yolñuw malaw ga ñayipi bungawany dhuwal
for people all and he himself boss this

Gondarra Guyuwu. Guyuwu ñayipi bungawany,
Gondarra Guyuwu. Guyuwu he himself boss,

yaka wiripu. Wiripu ñayi dharrwaw,
not other. Others he/it for many,

dharrwawdja ga ñuriki bulpulwunyyun dharrwany
for many and for that for feathers many

ga balanya ñayi Wili ñayipi bungawany
and thus he Wili he himself boss

ñurruguny, ñarrany marrgi.
first, I know.

4. Question: Who is he?

Answer: He Wili

Question: And who is that *mokuy* (dead one)? (Pause and question unanswered) What is that *mokuy* (spirit being)?

Answer: Spirit that other, that devil, (over) there, in a far place, it is sitting (staying) there in the jungle. far to there, There in the jungle (it) is sitting (staying). He's a spirit like yes like a shadow he is like an image. He made Banumbirr there. This is the way he did it. "This/here is for Djambarrpuyju, this/here is for Murrunjun, this/here is for Gunbirrdji and this/here is (what was it) for Balamumu," that's what that spirit said. Guluthumbirr is the name of that spirit, Guluthumbirr. The spirit's name is Guluthumbirr. Yes it is staying there at Gundalmirri. It's a big place Gundalmirri, and there's a very big jungle there full of spirits dancing, and dancing and dancing and that's the way they do it for that Banumbirr. Yes and they are crying (mourning), stabbing their heads (with sticks), the spirits there, those shadows, spirits. and making it. And, after that it is coming from there from that crying. There Banumbirr was made for everyone, for all people and he himself, Gondarra Guyuwu is the boss for this. Guyuwu he himself is the boss, not any other. It is for many others, for many and those feathers are for many and he Wili he himself is the boss first, I know.

Yo Dhuwa mala ŋunhi, yurr ŋaraka

Yes Dhuwa moiety that, but the core

ŋunhi guyulun ŋaraka, balanya. Ŋaraka bungawa

that Guyulun the core, thus. The core boss

Wili yan ŋayipi wangany ga dharrwawnydja

Wili just he himself alone and many

wanan, wanan, yo.

arms, arms, yes.

Question: What meaning for one arm? *Wangany mala?*
One group?

Answer: *Yaka gäna'gana, yo yo, yo.*
No separately, yes, yes, yes.

Question: *Wangany wana Djapu?* Answer: *Yo.*
One arm Djapu? Yes

Question: *Ga wiripu wana nhakuna ?*
And another arm like ?

Answer: *Djambarrpuyñu Lulmarranjur napurr, balanya,*
Djambarrpuyñu Lulmarranjur us, thus

ga nhawi Njymil ga Dätiwuy, yo balanya.
and (what's it) Njymil and Dätiwuy, yes thus.

Balanya ñunhi ga manda bungawany,
Thus there and pair of bosses

ñuriki ñarakawnydja. Nunhi ñarakawnydja manda
for that for the core. There for the core pair

Guyuwu Gondarra, ga galki nhanukal Gondarrawal,
Guyuwu Gondarra, and close with him with Gondarra,

Bulukmana, Yalwitjiñu, Garayalmana. Dhuwal ñarra
is Bulukmana, Yalwitjiñu, Garayalmana. This I

marngi dhäwuw, ga yuwalk dhäwu
am knowledgeable for the story, and truly the story

lakaram, ñarra ga, yaka nyäl, balanya.
telling, I am, not a lie thus.

5. Yes it belongs to the Dhuwa clans that (one), but (not) the core, that Guyulun the core. The core boss is Wili; just he himself alone and (it has) many arms, arms, yes

Question: What is the meaning for one arm? (Is it) One group?

Answer: No separately, yes, yes, yes.

Question: One arm is Djapu?

Answer: Yes

Question: And another arm like ?

Answer: Djambarrpuyŋu-Lulmarranur (that's) us, thus and (what's it) Ŋaymil and Dätiwuy, yes thus. There are a pair of bosses for that core. There are for the core a pair, Guyuwu Gondarra, and close with him, with Gondarra, is Bulukmana, Yalwitjŋu, Garayalmana. I am knowledgeable for the story, and I am telling the story truly. It's not a lie.

Question: What did you say the morning star does?

Answer: *Banumbirr ah yo yo djadaw'maram,*
Banumbirr ah yes yes makes the daylight,
daylight, balanya djadaw'maram. Ga ŋayi
daylight, thus makes the daylight. And it
ga djadaw'maram ga ŋayi ga ganga
and makes daylight and it and carefully
nhawi ŋayi Banumbirr ganga wandi ŋunhi
(what's it) it Banumbirr carefully runs there
räli dhurri ŋayi bil'pilyun marrtji, bil'pilyun.

to here returns it dawning coming, dawning.

Question: *Ga wanhaḡuru ḡayi dhu marrtji?*

And where from it will come?

Answer: *Mak walal ga lakaram be baman'tja,*

Maybe they were telling at the very origin,

nhawiḡur, mokuywal wāḡaḡur, Burralku.

(where was it), with the spirits at the place, Burralku

ḡarra ga lakaram Burralku.

I am telling Burralku.

Mak bāyḡu Burralku balanya ḡunhi.

Maybe nothing Burralku thus there.

Burralkuḡur giriḡirra ga bala ḡurrkaman

At Burralku dancing were then threw out

Banumbirrydja.

Banumbirr.

6. Question: What did you say the morning star does?

Answer: *Banumbirr* ah yes. It makes the daylight, daylight, thus makes the daylight. And it and makes daylight and it and it comes a little way.

Banumbirr only comes up partially into the sky and then it returns as the dawn comes, as it is dawning

Question: And where will it from come?

Answer: Maybe they were telling at the very origin it was with the spirits at that place, Burralku. I am saying Burralku, (but) maybe no such thing as

Burralku thus there. At Burralku (they) were dancing then threw out
Banumbirr.

Question: *Nhākurru?*

Where to?

Answer: *Rālin (nhawin) djaḍaw'maram ga ṅunhal.*

To here (what'sit) makes daylight and there.

ṅunhal buwatuta ga ṅunhal Marayuma

There the sea becomes and there at Marayuma
coloured by it

ga daylighttja nhanḡu dhu ga dhiyalnha

and daylight his will be here

balanya djaḍaw'yundja. Nhanḡu dhu dhiyalnha

thus becomes dawn. For it will here

Banumbirru. Ga balanya ṅunhi dhāwu.

for Banumbirr. And thus that story.

Yo baman'ṅuwuy yuwalk dhāwu ṅarra ṅunhi

Yes concerning the true story I there
origins

yindithin, ga ṅarra ṅāma dhuwali dhāwu.

become big, and I heard that story.

ṅarraku grandmother, ṅarraku grandfather,

My grandmother, my grandfather,

ṅarraku gurrupan, yo māri, raku yo.

for me gave, yes mother's mine yes.
mother's brother

7. Question: Where (did they throw it) to?

Answer: To here. It makes daylight, and there the sea becomes coloured by it at Marayuma and its daylight comes here and it becomes dawn. For Banumbirr, (daylight) will be here. And that the way the story goes. Yes, concerning the origins its the true story. When I had become big, I heard that story from my grandmother, (really) my grandfather, gave (it to me) yes my mother's mother's brother yes.

Question: *Nhä nhanu matha?* Answer: Golumala.

What his language? Golumala.

Ga dhuwala yolŋu dharrwa, märi ŋarraku,

And here people many, mother's mother's of mine, brothers

ga bulu rraku ŋunhi Guyulun, märi, yo

and also mine that Guyulun, mother's yes mother's brother,

balanya ŋunhi. Yo baman'ŋuwuy dhuwandja

thus that. Yes concerning origins this

gan djäma ŋunhi bulpulnydja, mokuy ŋuruŋdhi

was making there feathers, dead one that one did

yäkuy mokuyyu, nhe marŋgi nhawiyu yäkuy,

name dead one did, you know (what's it) name did,

Guluthumbirryu, ga wäŋa yäku

Guluthumbirr did, and place name

Gundalmirri. Yo ga ŋunhi Burralkuŋurnydja,

Gundalmirri. Yes and there at Burralku,

mak yol yäku, Yawulŋura, yo, Yawulŋura,

maybe who name, Yawulŋura, yes Yawulŋura,

Burralkuŋurnydja balanya.

at Burralku thus.

8. Question: What is his language?

Answer: Golumala. And here (there are) many people mother's mother's brothers of mine, and (it's) also mine that Guyulun, (because it is my) mother's mother's brother. Yes it's like that. Yes this is concerning origins. That mokuy (spirit being) was making it there with feathers, that spirit named Guluthumbirr did it at the place named *Gundalmirri*. Yes and there at Burralku, maybe who was it, Yawulŋura. Yes it was Yawulŋura at Burralku .

APPENDIX I.

WULUWUMA AND THE ORIGIN OF THE MORNING STAR

(As described by Yalkarriwuy)

Yalkarriwuy said that the morning star was made first by Wuluwuma. He saw the morning star in the sky and sat singing, "Dar', dar', dar' ". At Nandjinjur, (the other side of Yirrkala), he sat and *djäma* (work / make). He's the *gaptin / bungawa* (leader) for my place (named Gakupanjur). Wuluwuma lives in a jungle named *Dulmana / Gayku / Watharraka*, where there are many *ganguri* (a yam species), and that is his food. He walks through the jungle looking up for the yam flowers. *Ganguri djämamirri ñayi* (He is a ganguri yam maker / worker / gatherer). *Banumal / Ganinyidi / Dhurrjtithurrjtji* is the name of the digging stick for digging ganguri. It is a very long stick with both ends sharp.

When the *Banumbirr* (Morning Star) pole is made, the whole object also is *ganguri*. The long tassels decorated with *lindirritj* (rainbow lorikeet) feathers represent the creeper of the yam. Feathered clumps on the end of the tassels are *djuku*, (lice/fleas) that live on the plant. The stripes on the pole are the same as those on *wurrkadi* (unidentified grub or maggot). Names for the pole are *guyulun / maypurrumburr / yidirrwa*. Names for the *mokuy* (dead one) are *Dhänbul / Wudulanjiny / Yuwaypuma / Manyguluma / Nyidila*. *Wäña* (place) for *Banumbirr* is *Burralku / Dhunumbiyala*.

The bird *gukuk / laparr* (a dove) talks to the *mokuy* (dead one) saying *guk, guk*, and tells the location of the yams.

Lots of people use *Banumbirr* for the *bungul* (ceremony). When I make *Banumbirr*, I work right and use bush turkey *bulpul* (feathers) *Gurrkurr* (strings /sinews) *ñayi* (it) yam. *Guḍurrku* (brolga) is *bungan* (odour / essence) *nhanju* (for

him) Wuluwuma , also *bonba* (butterfly) and *gukuk* (Bar-shouldered dove). *Milkmilk* (mosquito) named *ganamu*, *burakina nanya* (mosquito sp. pierced him) and he went slapping it. At Maningrida they make *Banumbirr* with a long *raki* (string).

Wuluwuma is the name for the *mokuy* (dead one) from fresh water, *diltji* (bush) side and *Yaŋurraŋurr* is his name from the salt water *raŋi* (beach) side. Both are Gälpu.

Wurrkadi (an unidentified grub or perhaps maggot) lives in the ground and eats and spoils *ganguri* (yam). In paintings of *wurrkadi*, the "holes" are where *wurrkadi* goes in. The holes are also the place where we put items used in cleaning wounds. *Gululultja / wurrkadi* comes to them.